



Occasional Tables



Barrington | Cabin Creek | Camden | Chelsea | Clearview | Dallas
Gambo | Holton | Jamestown | Kenton | Riverton | Wayland

Barrington Occasionals



BR-1393-S



BR-1393-O



BR-1375-S



BR-1391-S



BR-1394-S



BR-1392-O

Standard Hardware



K272-SN

Go to the **Hardware & Stains** section for hardware upgrade options.

Barrington Occasionals

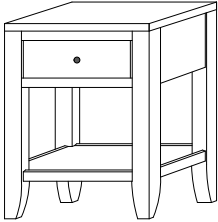

BR-1393-S
19¼"w x 24"h x 24"d
End Table w/shelf
w/1 drawer

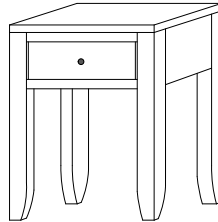

BR-1393-O
19¼"w x 24"h x 24"d
End Table Open w/no shelf
w/1 drawer

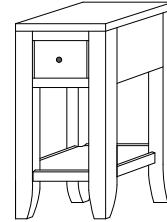

BR-1394-S
12"w x 24"h x 24"d
Chair Table w/shelf
w/1 drawer

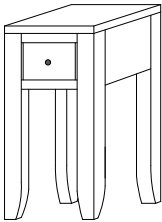

BR-1394-O
12"w x 24"h x 24"d
Chair Table Open w/no shelf
w/1 drawer

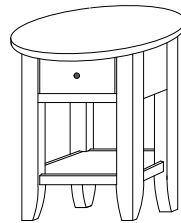

BR-1375-S
24"w x 24"h x 27"d
Oval Top Table w/shelf
w/1 drawer

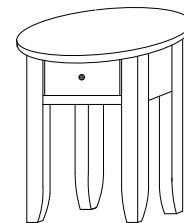

BR-1375-O
24"w x 24"h x 27"d
Oval Top Table Open w/no shelf
w/1 drawer

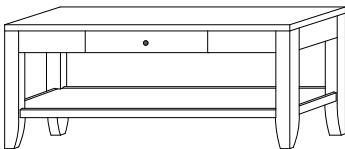

BR-1392-S
46"w x 19"h x 22"d
Coffee Table w/shelf
w/1 drawer

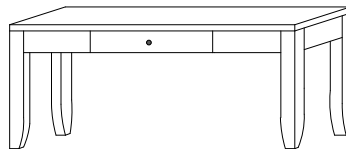

BR-1392-O
46"w x 19"h x 22"d
Coffee Table Open w/no shelf
w/1 drawer

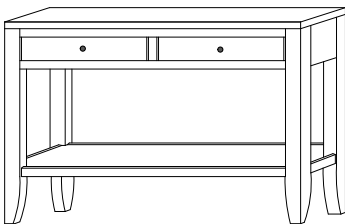

BR-1391-S
44"w x 29"h x 14"d
Sofa Table w/shelf
w/2 drawers

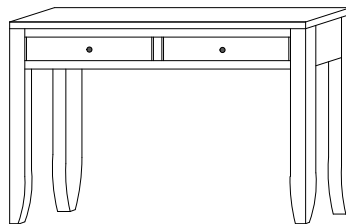

BR-1391-O
44"w x 29"h x 14"d
Sofa Table Open w/no shelf
w/2 drawers

Cabin Creek Occasionals



CA-590



CA-592



CA-591



CA-593



CA-594



CA-675



CA-678

Standard Hardware



Wood Knobs

Go to the **Hardware & Stains** section for upgrade options.

Cabin Creek Occasionals

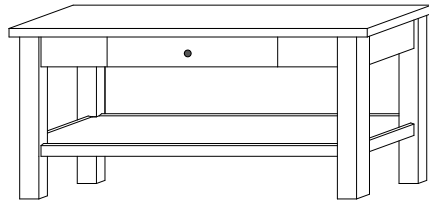

CA-590
42"w x 19"h x 24"d
Small Coffee Table w/1 drawer

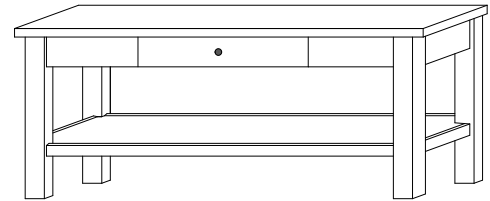

CA-592
48"w x 19"h x 24"d
Large Coffee Table w/1 drawer

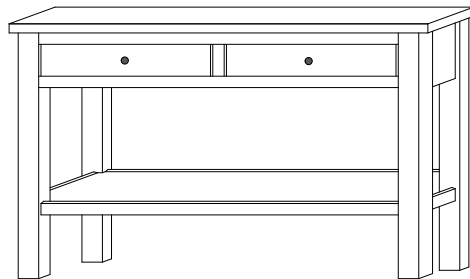

CA-591
46"w x 29"h x 16"d
Sofa Table w/2 drawers

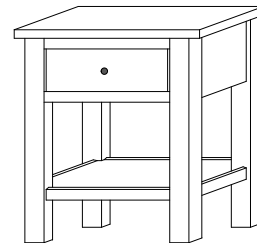

CA-593
21¼"w x 24"h x 26"d
End Table w/1 drawer

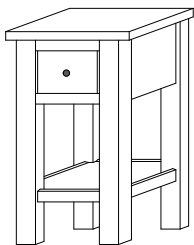

CA-594
14"w x 24"h x 26"d
Chair Table w/1 drawer

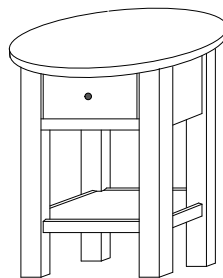

CA-675
24"w x 24"h x 27"d
Oval Top Table w/1 drawer

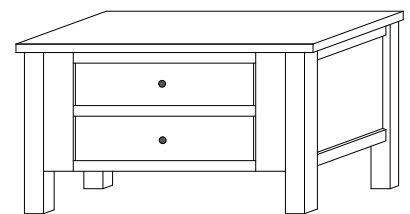

CA-678
35"w x 19"h x 35"d
Coffee Table w/2 drawers

Camden Occasionals



CN-5291



CN-5292



CN-5293



CN-5294

Standard Hardware

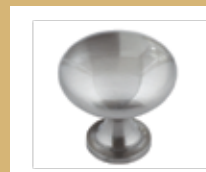

K 800-SN Knobs

Go to the **Hardware & Stains** section for upgrade options.

Camden Occasionals

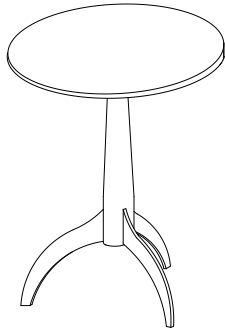

CN-5275
17 $\frac{1}{4}$ "w x 23 $\frac{3}{4}$ "h x 17"d
Round Table

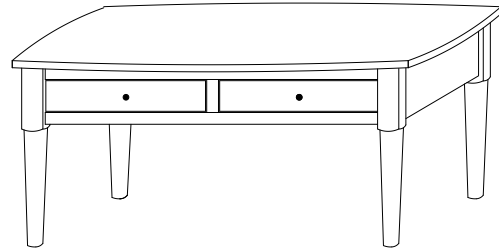

CN-5290
44"w x 18 $\frac{3}{4}$ "h x 26"d
Coffee Table w/2 drawers

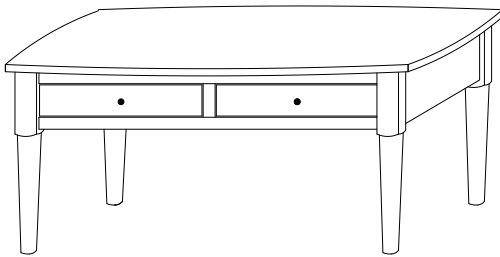

CN-5292
50"w x 18 $\frac{3}{4}$ "h x 26"d
Coffee Table w/2 drawers

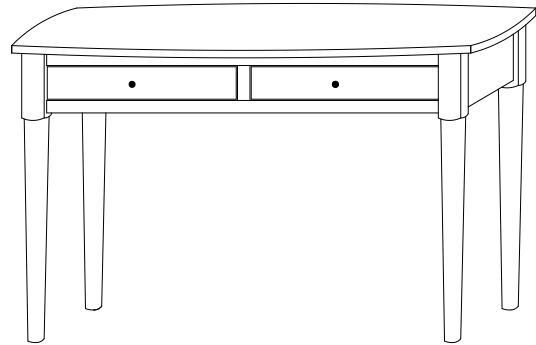

CN-5291
48"w x 28 $\frac{3}{4}$ "h x 18"d
Sofa Table w/2 drawers

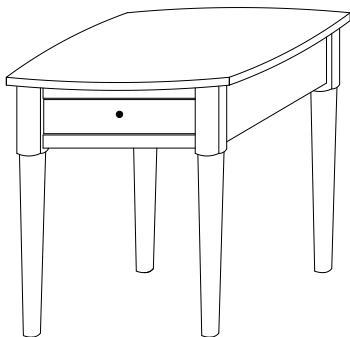

CN-5293
23 $\frac{1}{4}$ "w x 23 $\frac{3}{4}$ "h x 28"d
End Table w/1 drawer



CN-5294
16"w x 23 $\frac{3}{4}$ "h x 28"d
Chair Table w/1 drawer

Chelsea Occasionals



CS-1691



CS-1692



CS-1693



CS-1694

Standard Hardware



53005-ORB

Go to the **Hardware & Stains** section for upgrade options.

Chelsea Occasionals

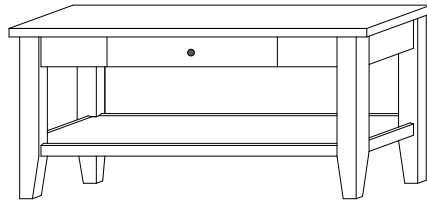

CS-1690
42"w x 19"h x 24"d
Small Coffee Table w/1 drawer

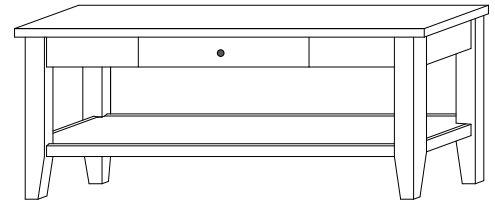

CS-1692
48"w x 19"h x 24"d
Large Coffee Table w/1 drawer

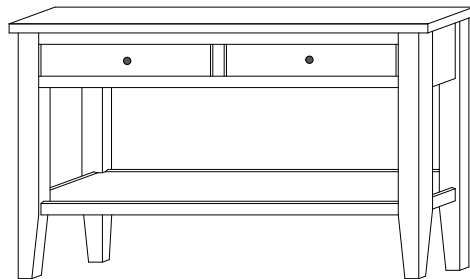

CS-1691
46"w x 29"h x 16"d
Sofa Table w/2 drawers

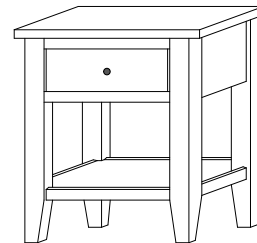

CS-1693
21¼"w x 24"h x 26"d
End Table w/1 drawer

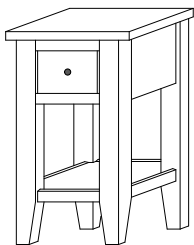

CS-1694
14"w x 24"h x 26"d
Chair Table w/1 drawer

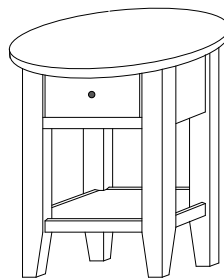

CS-1675
24"w x 24"h x 27"d
Oval Top Table w/1 drawer

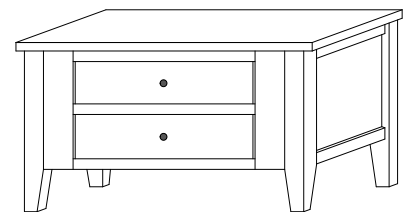

CS-1678
35"w x 19"h x 35"d
Coffee Table w/2 drawers

Clearview Occasionals



CV-5291



CV-5790



CV-5794



CV-5793

Standard Hardware



55276-26 Pull

Go to the **Hardware & Stains** section for upgrade options.

Clearview Occasionals

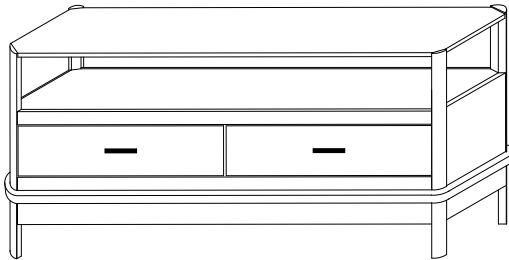

CV-5790
41½"w x 19"h x 23½"d
Coffee Table w/2 drawers

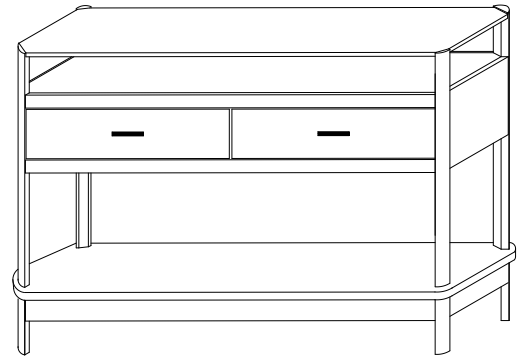

CV-5291
45½"w x 29"h x 15½"d
Sofa Table w/2 drawers

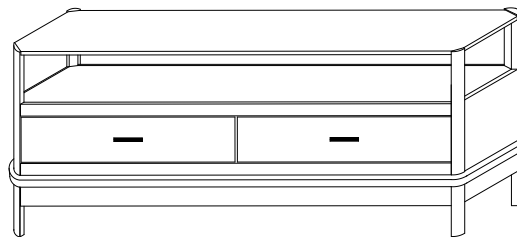

CV-5792
47½"w x 19"h x 23½"d
Coffee Table w/2 drawers

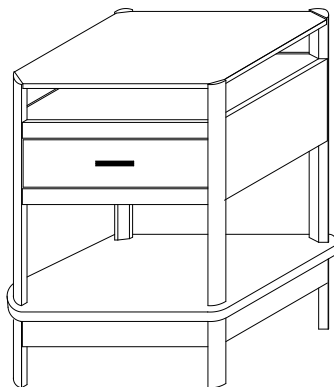

CV-5793
20¾"w x 24"h x 25½"d
End Table w/1 drawer

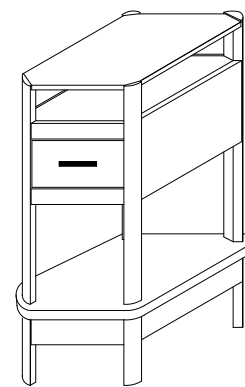

CV-5794
13½"w x 24"h x 25½"d
Chair Table w/1 drawer

Dallas Occasionals



DS-5191



DS-5192



DS-5193



DS-5194

Standard Hardware



4424-BL Pull

Go to the **Hardware & Stains** section for upgrade options.

Dallas Occasionals

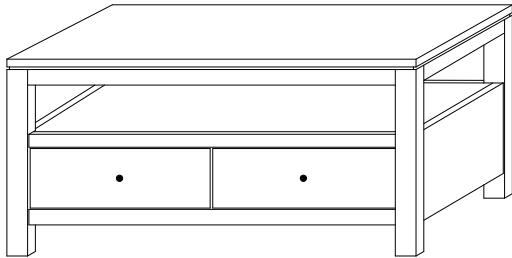

DS-5190
39½"w x 19"h x 21½"d
Coffee Table w/2 drawers

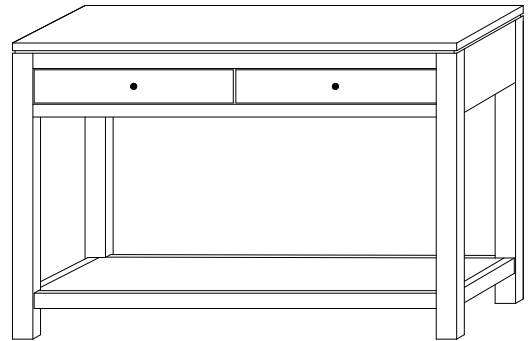

DS-5191
43½"w x 29"h x 13½"d
Sofa Table w/2 drawers

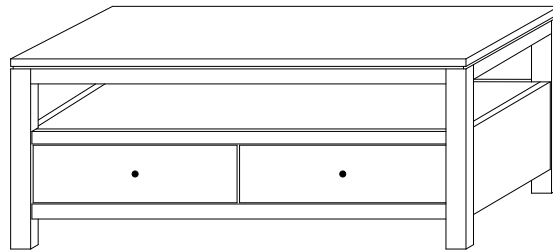

DS-5192
45½"w x 19"h x 21½"d
Coffee Table w/2 drawers

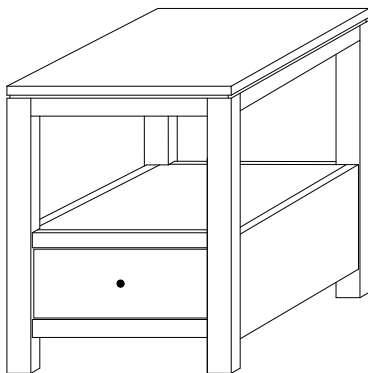

DS-5193
18¾"w x 24"h x 23½"d
End Table w/1 drawer

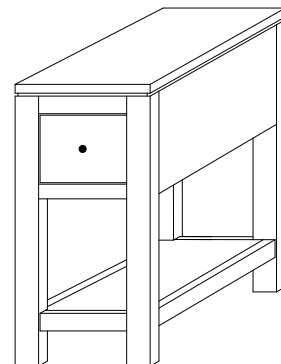

DS-5194
11½"w x 24"h x 23½"d
Chair Table w/1 drawer

Gambo Occasionals



GB-5590



GB-5591



GB-5575



GB-5593



GB-5594

Standard Hardware



4425-BL Knob

Go to the Hardware & Stains section for upgrade options.

Gambo Occasionals

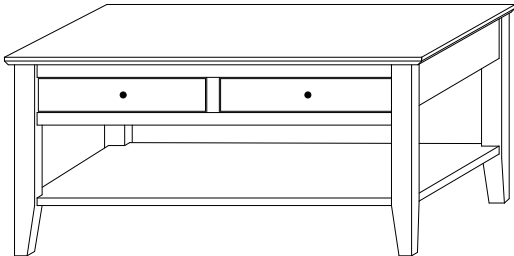

GB-5590
41½"w x 18¾"h x 23½"d
Coffee Table w/2 drawers

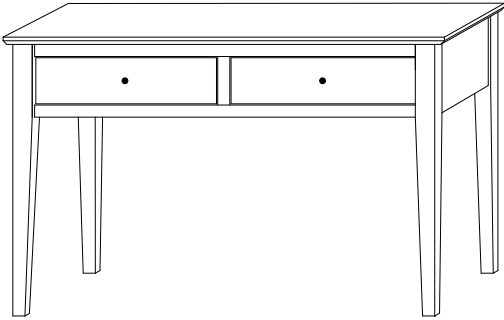

GB-5591
45½"w x 28¾"h x 15½"d
Sofa Table w/2 drawers

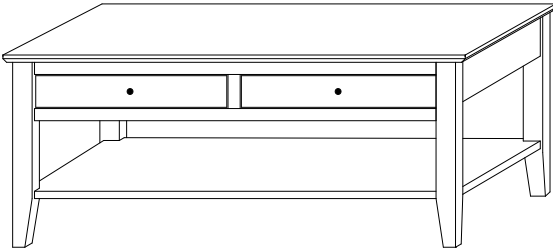

GB-5592
47½"w x 18¾"h x 23½"d
Coffee Table w/2 drawers

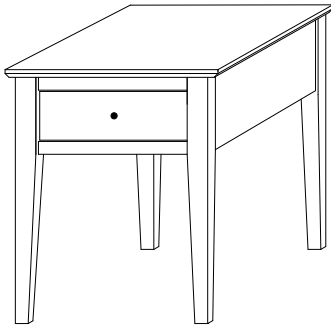

GB-5593
20¾"w x 23¾"h x 25½"d
End Table w/1 drawer

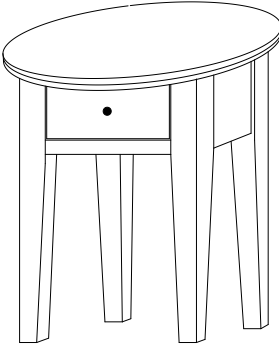

GB-5575
23½"w x 23¾"h x 26½"d
Oval Top Table

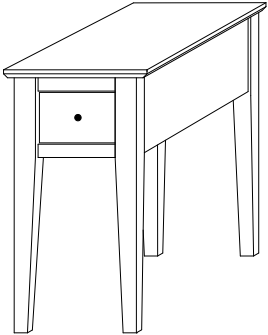

GB-5594
13½"w x 23¾"h x 25½"d
Chair Table

Holton Occasionals



HN-5890



HN-5891



HN-5893



HN-5894

Standard Feature:
*Reclaimed Tops
2-tone*

Standard Hardware



4425-ORB Knob

Go to the **Hardware & Stains** section for upgrade options.

Holton Occasionals

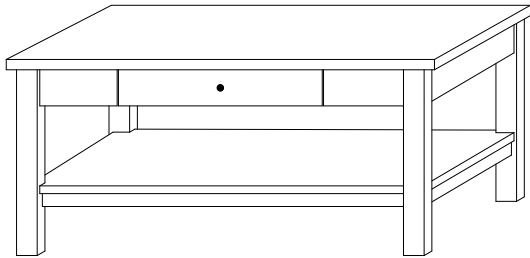

HN-5890
41½"w x 19¼"h x 23½"d
Coffee Table w/1 drawer

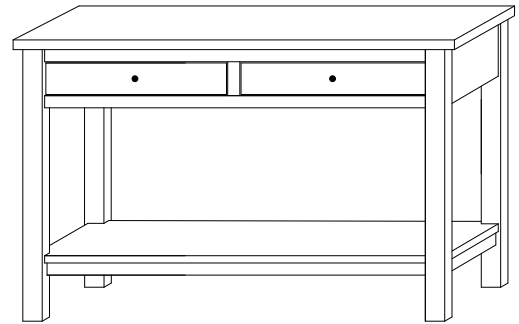

HN-5891
45½"w x 29¼"h x 15½"d
Sofa Table w/2 drawers

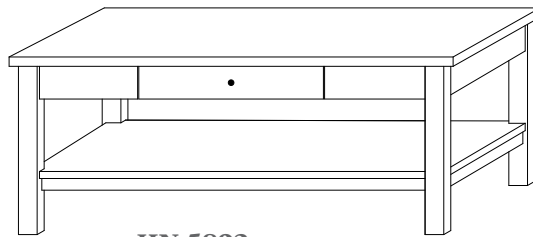

HN-5892
47½"w x 19¼"h x 23½"d
Coffee Table w/1 drawers

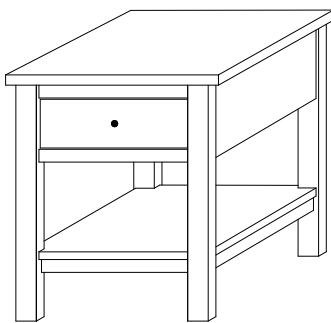

HN-5893
20¾"w x 24¼"h x 25½"d
End Table w/1 drawer

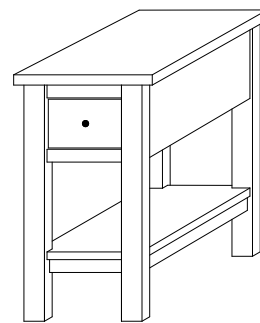

HN-5894
13½"w x 24¼"h x 25½"d
Chair Table w/1 drawer

Jamestown Occasionals



JT-5690



JT-5691



JT-5693



JT-5694



JT-5675

Standard Hardware



K810-MB Knob

Go to the *Hardware & Stains* section for upgrade options.

Jamestown Occasionals

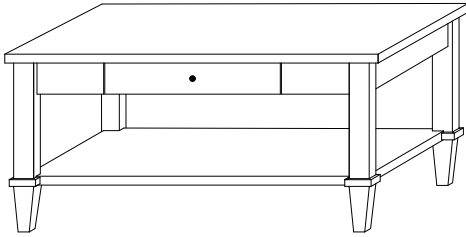

JT-5690
42"w x 19"h x 24"d
Coffee Table w/1 drawer

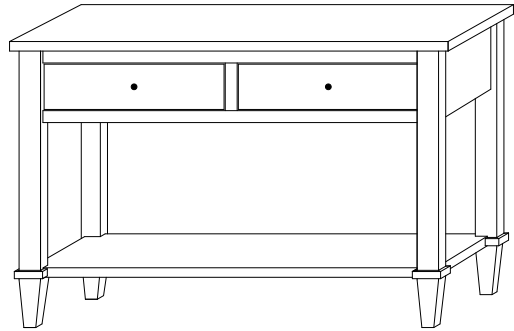

JT-5691
46"w x 29"h x 16"d
Sofa Table w/2 drawers

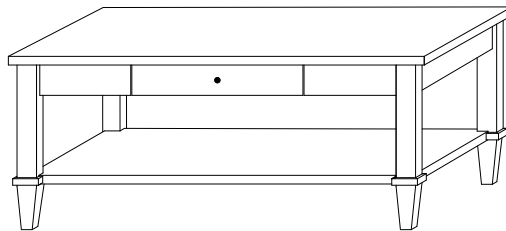

JT-5692
48"w x 19"h x 24"d
Coffee Table w/1 drawer

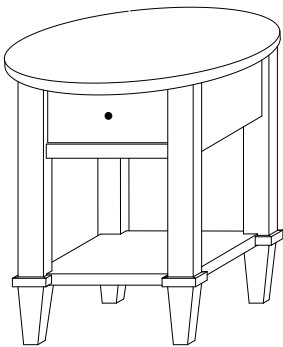

JT-5675
24"w x 24"h x 27"d
Oval Top Table w/1 drawer

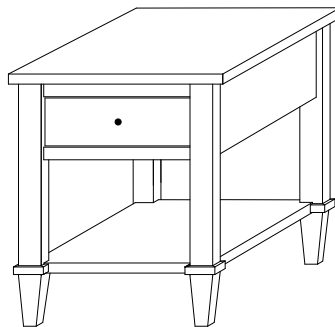

JT-5693
21¼"w x 24"h x 26"d
End Table w/1 drawer

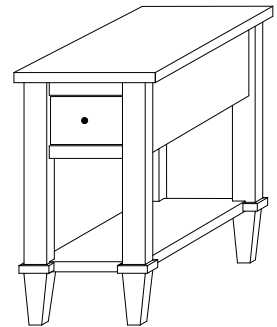

JT-5694
14"w x 24"h x 26"d
Chair Table w/1 drawer

Kenton Occasionals



KT-5490



KT-5491



KT-5493



KT-5494



KT-5475

Standard Hardware



53700-BBZ Knob

Go to the *Hardware & Stains* section for upgrade options.

Kenton Occasionals

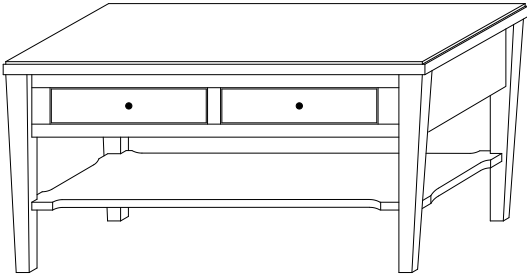

KT-5490
40½"w x 19"h x 22½"d
Coffee Table w/2 drawers

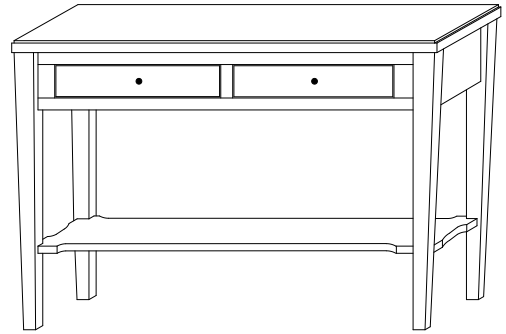

KT-5491
46"w x 29"h x 14½"d
Sofa Table w/2 drawers

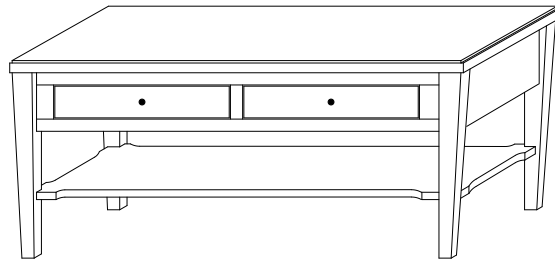

KT-5492
46½"w x 19"h x 22½"d
Coffee Table w/2 drawers

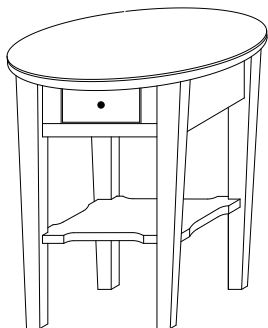

KT-5475
24"w x 24"h x 27"d
Oval Top Table w/1 drawer

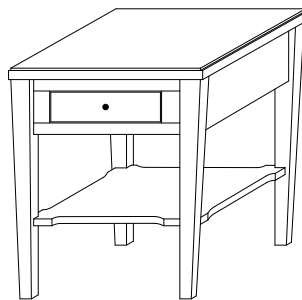

KT-5493
21¼"w x 24"h x 24½"d
End Table w/1 drawer

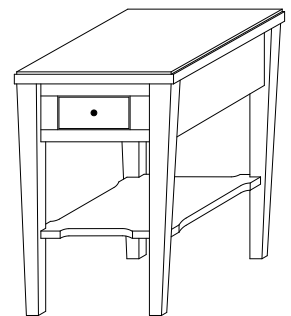

KT-5494
16½"w x 24"h x 24½"d
Chair Table w/1 drawer

Riverton Occasionals



RT-5390-S



RT-5391



RT-5393



RT-5390-D



RT-5394

Standard Hardware



1586-G10 Knob

Go to the *Hardware & Stains* section for upgrade options.

Riverton Occasionals

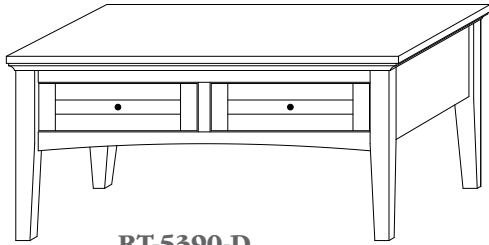

RT-5390-D
41½"w x 19½"h x 23½"d
Coffee Table w/2 drawers

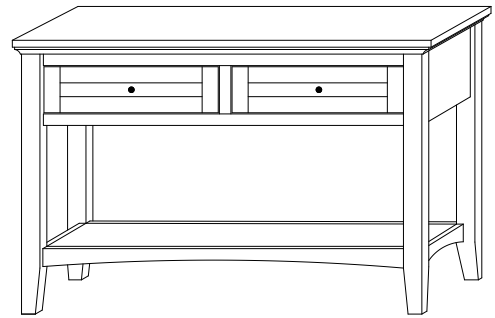

RT-5391
45½"w x 29½"h x 15½"d
Sofa Table w/2 drawers

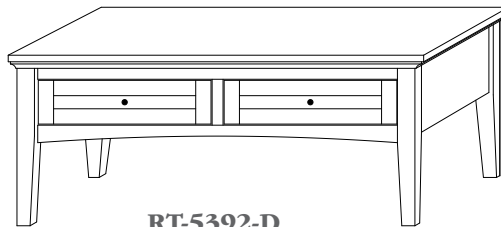

RT-5392-D
47½"w x 19½"h x 23½"d
Coffee Table w/2 drawers

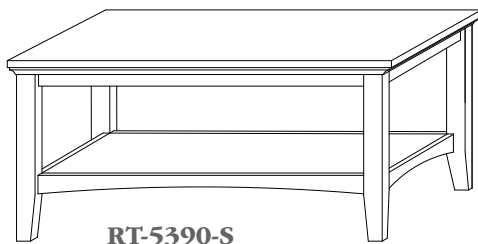

RT-5390-S
41½"w x 19½"h x 23½"d
Coffee Table w/1 Open Shelf

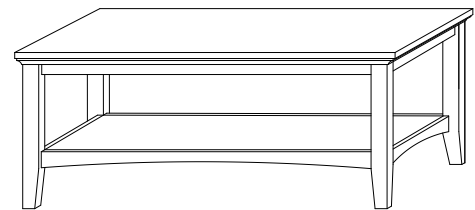

RT-5392-S
47½"w x 19½"h x 23½"d
Coffee Table w/1 Open Shelf

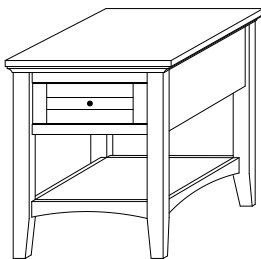

RT-5393
20¾"w x 24½"h x 25½"d
End Table w/1 drawer

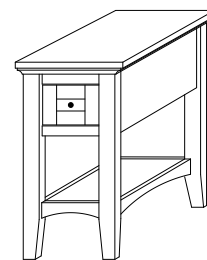

RT-5394
13½"w x 24½"h x 25½"d
Chair Table w/1 drawer

Wayland Occasionals



WD-5090



WD-5094



WD-5075

Standard Hardware



3915-DBAC Knob

Go to the **Hardware & Stains** section for upgrade options.

Wayland Occasionals

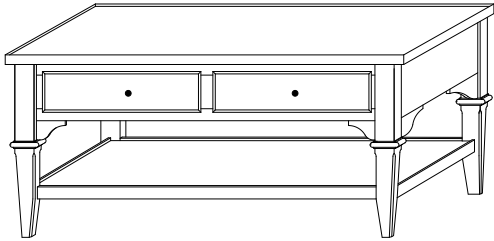

WD-5090
41½"w x 19"h x 23½"d
Coffee Table w/2 drawers

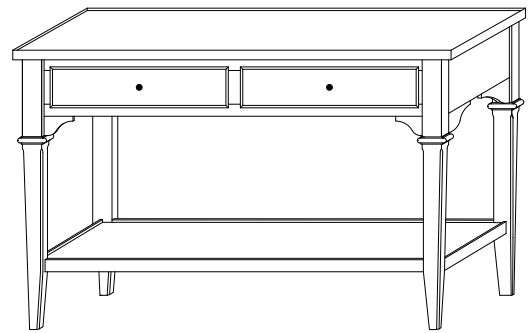

WD-5091
45"w x 29"h x 15½"d
Sofa Table w/2 drawers

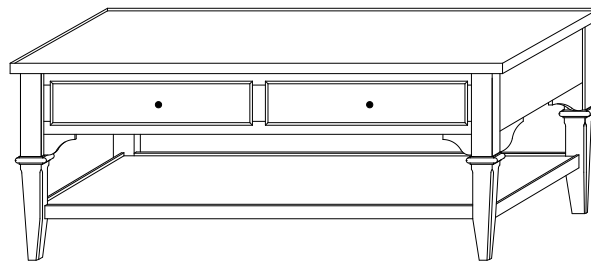

WD-5092
47½"w x 19½"h x 23½"d
Coffee Table w/2 drawers

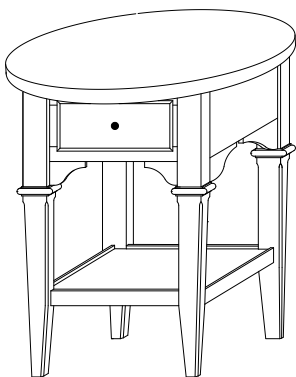

WD-5075
22"w x 24"h x 25"d
Oval Top Table

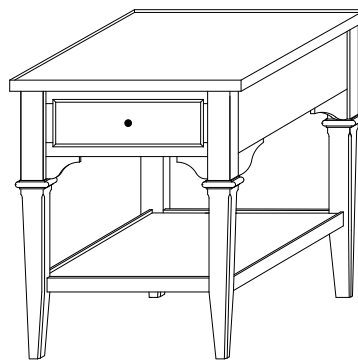

WD-5093
20¾"w x 24"h x 25½"d
End Table w/1 drawers

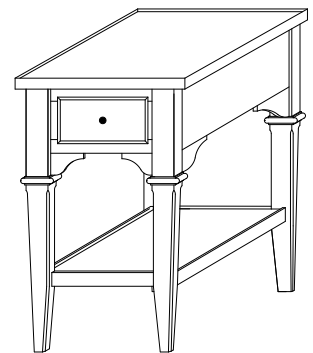

WD-5094
15½"w x 24"h x 25½"d
End Table w/1 drawers



Kitchen Islands

Customize the perfect kitchen island for you!

Step 1: Select your base* style and size.

Step 2: Select any available base feature options.

Step 3: Select your top* style, size† and features.

* All island bases and tops are priced and sold separately.

† Add 7" to 10" of overhang if using barstools at the island.



Bridgeport | Brookline | Constance Bay | Jefferson City

Kingston | Oceanside | Roseburg | Traditional | Turned Leg

Designer Series | Designer Series Turned Leg | Table Bases | Table Pullouts

Bridgeport Island Bases



IS-2071



IS-2073



Shown with optional
slideout wastebasket and
slideout cutting board.

IS-2076



IS-2074



Shown with optional
3 Tier Pullout

IS-2078

Available Feature Options



#4550
**Slideout
Wastebasket**
w/2 wastebaskets



#4552
**3 Tier
Pullout**



#4553
**Pullout
Cutting Board**
w/hole cutout



#4554
Sliding Shelf
replaces an
adjustable shelf

Bridgeport Island Bases

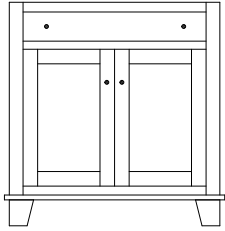

IS-2071
32½"w 34½"h 24"d
w/1 drawer 2 doors
w/1 adjustable shelf

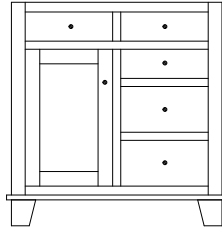

IS-2073
32½"w 34½"h 24"d
w/5 drawers 1 door
w/1 adjustable shelf

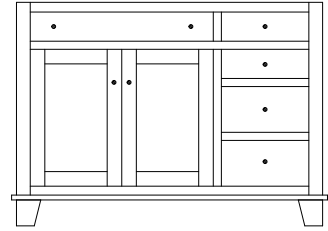

IS-2074
47¼"w 34½"h 24"d
w/5 drawers 2 doors
w/1 adjustable shelf

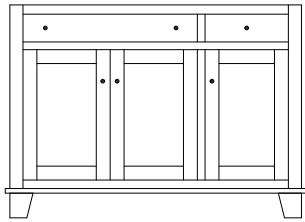

IS-2076
47¼"w 34½"h 24"d
w/2 drawers 3 doors
w/2 adjustable shelves

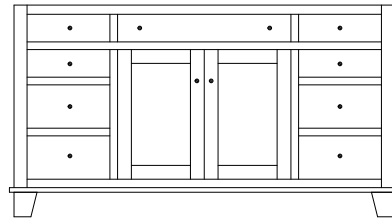

IS-2078
62"w 34½"h 24"d
w/9 drawers 2 doors
w/1 adjustable shelves

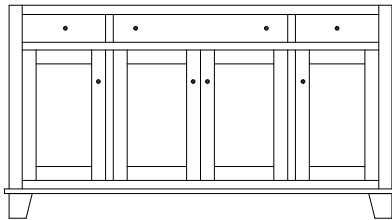

IS-2081
62"w 34½"h 24"d
w/3 drawers 4 doors
w/3 adjustable shelves

Standard Hardware



K527 DACM

See the *Hardware & Stains* section for available hardware upgrades.



#4555
Mixer Lift
w/pullout shelf
(in place of regular
drawer and door)



#4556
Wheel Caster
w/brake hidden by
adding skirting



#4561
Wine Rack
in place of door



#4570
10" Leg Extension

Brookline Island Bases



IS-802



IS-803



IS-801



Shown with optional
slideout wastebasket.

IS-805



IS-804



Shown with Ext. Top

IS-808

Available Feature Options



#4550
Slideout
Wastebasket
w/2 wastebaskets



#4552
3 Tier
Pullout



#4553
Pullout
Cutting Board
w/hole cutout



#4554
Sliding Shelf
replaces an
adjustable shelf

Brookline Island Bases

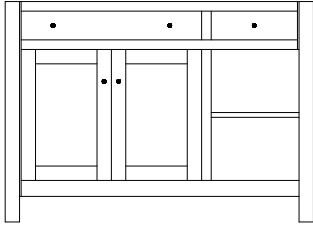

IS-801
47¾"w 34½"h 24½"d
w/2 drawers 2 doors
w/1 adjustable shelf, 1 open shelf

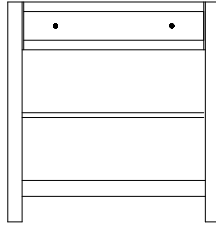

IS-802
32¾"w 34½"h 24½"d
w/1 drawer
w/1 open shelf

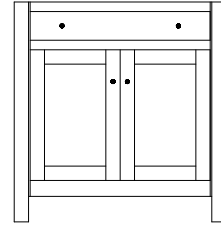

IS-803
32¾"w 34½"h 24½"d
w/1 drawer 2 doors
w/1 adjustable shelf

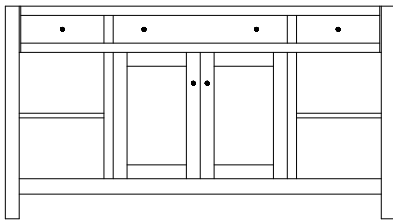

IS-804
62¾"w 34½"h 24½"d
w/3 drawers 2 doors
1 adjustable shelf, 2 open shelves

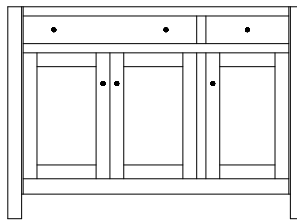

IS-805
47¾"w 34½"h 24½"d
w/2 drawers 3 doors
w/2 adjustable shelves

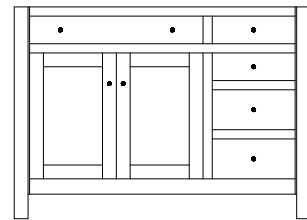

IS-806
47¾"w 34½"h 24½"d
w/5 drawers 2 doors
w/1 adjustable shelf

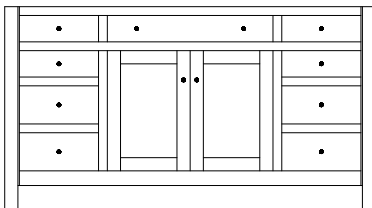

IS-808
62¾"w 34½"h 24½"d
w/9 drawers 2 doors
w/1 adjustable shelf

Standard Hardware



4424-ORB/4425-ORB

See the *Hardware & Stains* section for available hardware upgrades.



#4555
Mixer Lift
w/pullout shelf
(in place of regular
drawer and door)



#4558
Brookline Caster



#4560
Concealed Caster



#4561
Wine Rack
in place of door

Constance Bay Island Bases



IS-205



IS-206



Shown with optional slideout wastebasket. IS-207



IS-209



IS-211

Available Feature Options



#4550
Slideout
Wastebasket
w/2 wastebaskets



#4552
3 Tier
Pullout



#4553
Pullout
Cutting Board
w/hole cutout



#4554
Sliding Shelf
replaces an
adjustable shelf

Constance Bay Island Bases

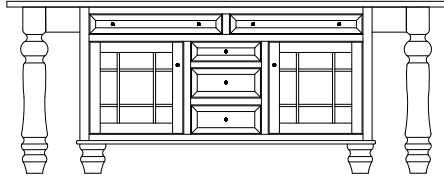

IS-205
92"w 34½"h 30"d
w/7 drawers 2 doors
w/2 adjustable shelves

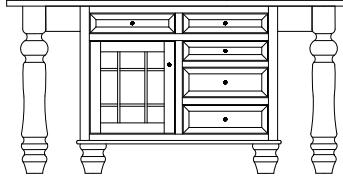

IS-206
75"w 34½"h 30"d
w/7 drawers 1 door
w/1 adjustable shelf

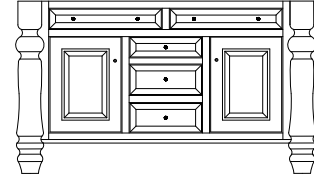

IS-207
62½"w 34½"h 24½"d
w/5 drawers 2 doors
w/2 adjustable shelves

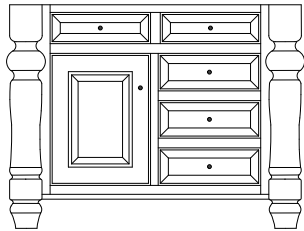

IS-208
45"w 34½"h 24½"d
w/5 drawers 1 door
w/1 adjustable shelf

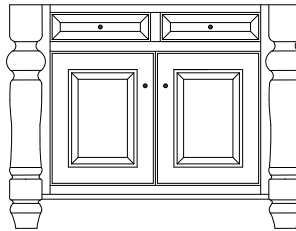

IS-209
45"w 34½"h 24½"d
w/2 drawers 2 doors
w/1 adjustable shelf

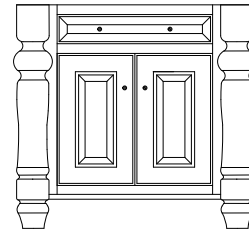

IS-210
36½"w 34½"h 24½"d
w/1 drawer 2 doors
w/1 adjustable shelf

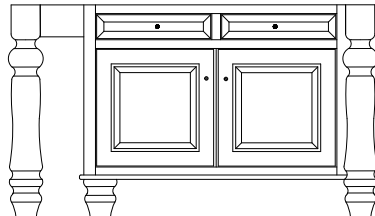

IS-211
65¼"w 34½"h 30"d
w/2 drawers 2 doors
w/1 adjustable shelf

Standard Hardware



1¼" Wood Knobs

See the *Hardware & Stains* section for available hardware upgrades.



#4555
Mixer Lift
w/pullout shelf
(in place of regular
drawer and door)



#4556
Wheel Caster
w/brake hidden by
adding skirting



#4561
Wine Rack
in place of door

Jefferson City Traditional Island Bases



IS-73-JC



IS-71-JC



Shown with optional
slideout wastebasket.

IS-76-JC



IS-74-JC



IS-78-JC

Available Feature Options



#4550
Slideout
Wastebasket
w/2 wastebaskets



#4551
Tiltout
Wastebasket
w/1 wastebasket



#4552
3 Tier
Pullout



#4553
Pullout
Cutting Board
w/hole cutout

Jefferson City Traditional Island Bases

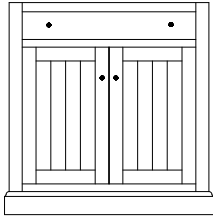

IS-71-JC
32½"w 34½"h 24"d
w/1 drawer 2 doors
w/1 adjustable shelf

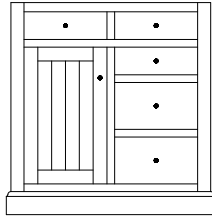

IS-73-JC
32½"w 34½"h 24"d
w/5 drawers 1 door
w/1 adjustable shelf

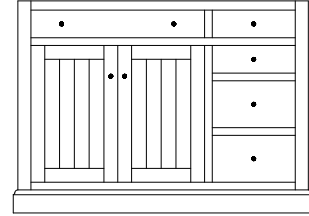

IS-74-JC
47¼"w 34½"h 24"d
w/5 drawers 2 doors
w/1 adjustable shelf

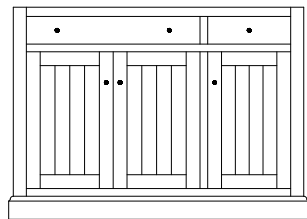

IS-76-JC
47¼"w 34½"h 24"d
w/2 drawers 3 doors
w/2 adjustable shelves

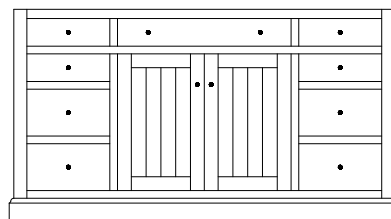

IS-78-JC
62"w 34½"h 24"d
w/9 drawers 2 doors
w/1 adjustable shelf

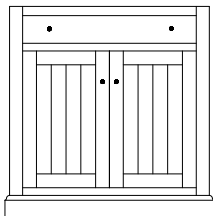

IS-79-JC
32½"w 34½"h 18"d
w/1 drawer 2 doors
w/1 adjustable shelf

Standard Hardware



1¼" Wood Knobs

See the *Hardware & Stains* section for available hardware upgrades.



#4554
Sliding Shelf
replaces an
adjustable shelf



#4555
Mixer Lift
w/pullout shelf
(in place of regular
drawer and door)



#4559
Concealed Caster



#4561
Wine Rack
in place of door

Jefferson City Turned Leg Island Bases



IS-68-JC



IS-69L-JC



IS-84-JC



Shown with optional
slideout wastebasket.

IS-98-JC



IS-96-JC



Shown with optional
slideout wastebasket.

IS-86-JC



IS-99R-JC



Dress up your island with one of these specialty legs!

- A #4562 Fluted
- B #4563 Reeded
- C #4564 Diamond
- D #4565 Rope Twist

Specialty Leg Options

Available Feature Options



#4550
**Slideout
Wastebasket**
w/2 wastebaskets



#4551
**Tiltout
Wastebasket**
w/1 wastebasket



#4552
**3 Tier
Pullout**



#4553
**Pullout
Cutting Board**
w/hole cutout

Jefferson City Turned Leg Island Bases

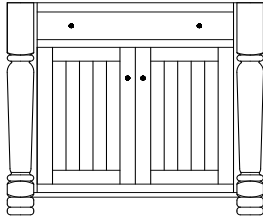

IS-68-JC
37½"w 34½"h 24½"d
w/1 drawer 2 doors
w/1 adjustable shelf

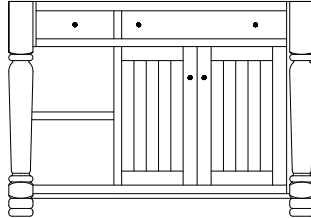

IS-69L-JC / IS-69R-JC
49"w 34½"h 24½"d
w/2 drawers 2 doors
w/1 adjustable shelf, 1 open shelf

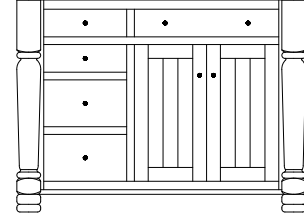

IS-84-JC
49"w 34½"h 24½"d
w/5 drawers 2 doors
w/1 adjustable shelf

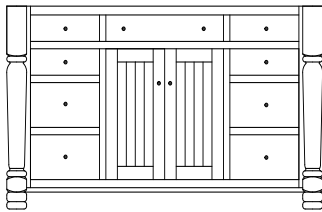

IS-86-JC
61¾"w 34½"h 24½"d
w/9 drawers 2 doors
w/1 adjustable shelf

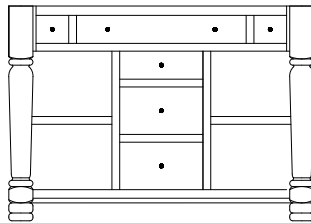

IS-94-JC
49"w 34½"h 24½"d
w/6 drawers, 2 open shelves

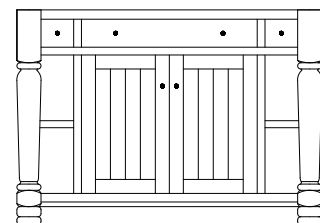

IS-96-JC
49"w 34½"h 24½"d
w/3 drawers 2 doors
w/1 adjustable shelf, 2 open shelves

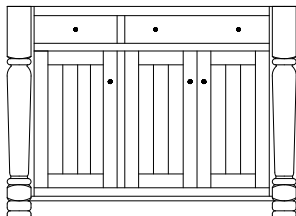

IS-98-JC
49"w 34½"h 24½"d
w/2 drawers 3 doors
w/2 adjustable shelves

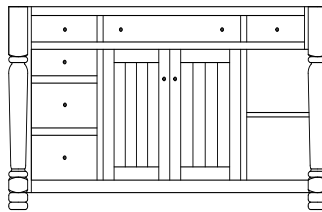

IS-99L-JC / IS-99R-JC
62"w 34½"h 24½"d
w/6 drawers 2 doors
w/1 adjustable shelf, 1 open shelf

Standard Hardware



1¼" Wood Knobs

See the *Hardware & Stains* section for available hardware upgrades.



#4554
Sliding Shelf
replaces an
adjustable shelf



#4555
Mixer Lift
w/pullout shelf
(in place of regular
drawer and door)



#4556
Wheel Caster
w/brake hidden by
adding skirting



#4557
3" Ball Caster
w/brake



#4561
Wine Rack
in place of door

Kingston Island Bases



IS-1245



Shown with Venice bar stools

Available Feature Options



#4550
**Slideout
Wastebasket**
w/2 wastebaskets



#4572
**2 Tier
Pullout**



#4552
**3 Tier
Pullout**



#4553
**Pullout
Cutting Board**
w/hole cutout

Kingston Island Bases

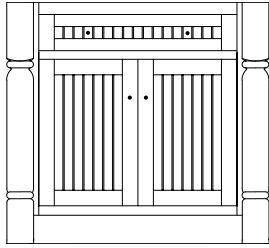

IS-1240
37½"w 34½"h 24½"d
w/1 drawer, 2 doors
w/1 adjustable shelf

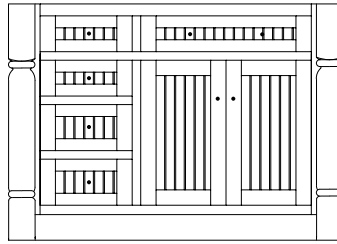

IS-1241
49¼"w 34½"h 24½"d
w/5 drawers, 2 doors
w/1 adjustable shelf

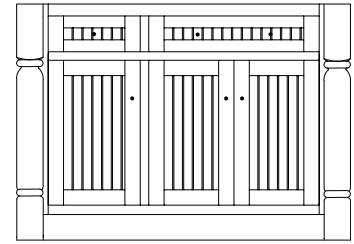

IS-1242
49¼"w 34½"h 24½"d
w/2 drawers, 3 doors
w/2 adjustable shelves

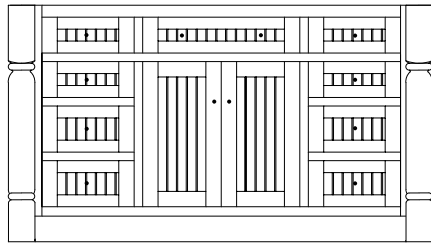

IS-1243
62"w 34½"h 24½"d
w/9 drawers, 2 doors
w/1 adjustable shelf

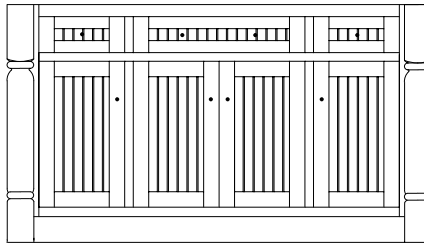

IS-1244
62"w 34½"h 24½"d
w/3 drawers, 4 doors
w/3 adjustable shelves

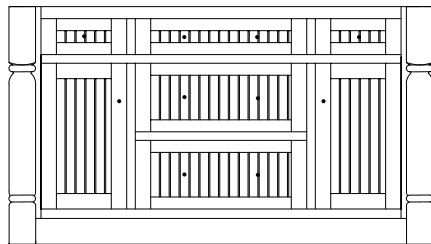

IS-1245
62"w 34½"h 24½"d
w/5 drawers, 2 doors
w/2 adjustable shelves

Standard Hardware



53710 GPH/53715 GPH

See the *Hardware & Stains* section for available hardware upgrades.



#4554
Sliding Shelf
replaces an
adjustable shelf



#4559
Concealed Caster



#4570
10" Leg Extension

Oceanside Island Bases



IS-662



IS-663



IS-664



Shown with optional
slideout wastebasket.

IS-665



IS-668

Available Feature Options



#4550
Slideout
Wastebasket
w/2 wastebaskets



#4552
3 Tier
Pullout



#4554
Sliding Shelf
replaces an
adjustable shelf

Oceanside Island Bases

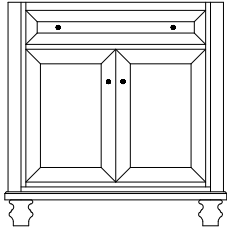

IS-662
 33¼"w 34½"h 24½"d
 w/1 drawer 2 doors
 w/1 adjustable shelf

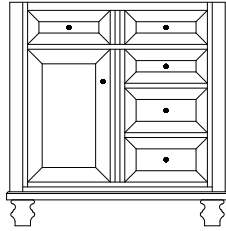

IS-663
 33¼"w 34½"h 24½"d
 w/5 drawers 1 door
 w/1 adjustable shelf

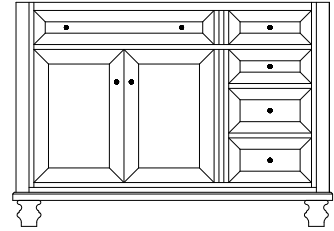

IS-664
 48¼"w 34½"h 24½"d
 w/5 drawers 2 doors
 w/1 adjustable shelf

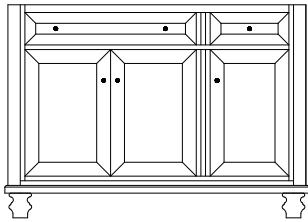

IS-665
 48¼"w 34½"h 24½"d
 w/2 drawers 3 doors
 w/2 adjustable shelves

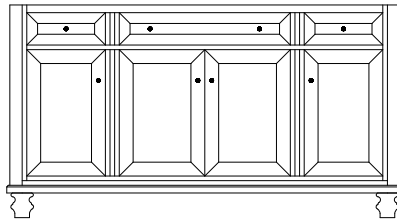

IS-666
 63¼"w 34½"h 24½"d
 w/3 drawers 4 doors
 w/3 adjustable shelves

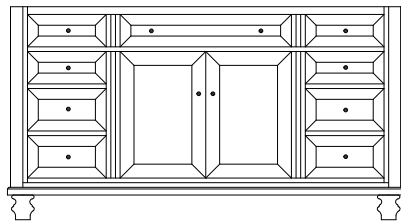

IS-668
 63¼"w 34½"h 24½"d
 w/9 drawers 2 doors
 w/1 adjustable shelf

Standard Hardware



1586-ORB

See the *Hardware & Stains* section for available hardware upgrades.



#4555
Mixer Lift
 w/pullout shelf
 (in place of regular
 drawer and door)



#4556
Wheel Caster
 w/brake hidden by
 adding skirting



#4561
Wine Rack
 in place of door

Roseburg Island Bases



Shown with Ext. Top

IS-1026



Shown with optional slideout wastebasket.

IS-1027

Available Feature Options



#4550
**Slideout
Wastebasket**
w/2 wastebaskets



#4552
**3 Tier
Pullout**



#4554
Sliding Shelf
replaces an
adjustable shelf

Roseburg Island Bases

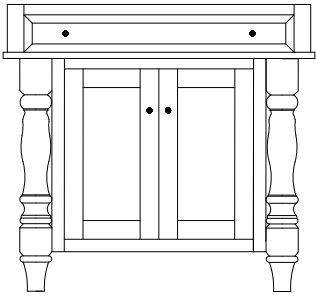

IS-1025
 37½"w 34½"h 24½"d
 w/1 drawer 2 doors
 w/1 adjustable shelf

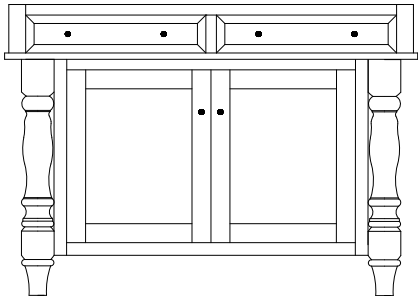

IS-1026
 49"w 34½"h 24½"d
 w/2 drawers 2 doors
 w/1 adjustable shelf

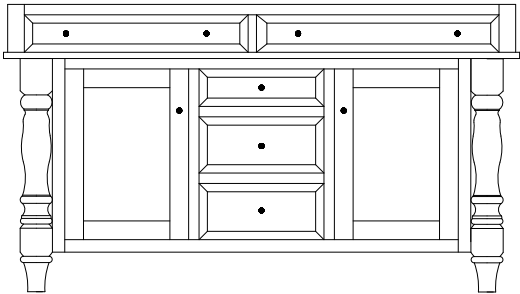

IS-1027
 62"w 34½"h 24½"d
 w/5 drawers 2 doors
 w/2 adjustable shelves

Standard Hardware



1¼" Wood Knobs

*See the **Hardware & Stains** section for available hardware upgrades.*



#4556
Wheel Caster
 w/brake hidden by
 adding skirting



#4561
Wine Rack
 in place of door

Traditional Island Bases



IS-79



IS-74



Shown with optional mixer lift and slide out shelf. IS-76



Shown with optional slideout wastebasket. IS-78

Available Feature Options



#4550
Slideout
Wastebasket
w/2 wastebaskets



#4551
Tiltout
Wastebasket
w/1 wastebasket



#4552
3 Tier
Pullout



#4553
Pullout
Cutting Board
w/hole cutout

Traditional Island Bases

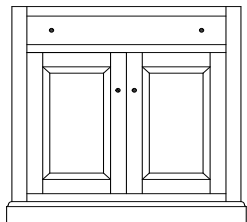

IS-71
32½"w 34½"h 24"d
w/1 drawer 2 doors
w/1 adjustable shelf

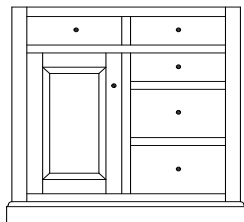

IS-73
32½"w 34½"h 24"d
w/5 drawers 1 door
w/1 adjustable shelf

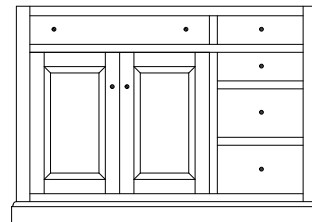

IS-74
47¼"w 34½"h 24"d
w/5 drawers 2 doors
w/1 adjustable shelf

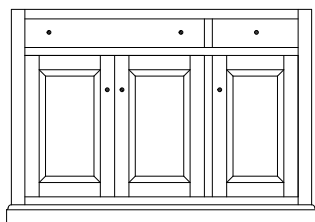

IS-76
47¼"w 34½"h 24"d
w/2 drawers 3 doors
w/2 adjustable shelves

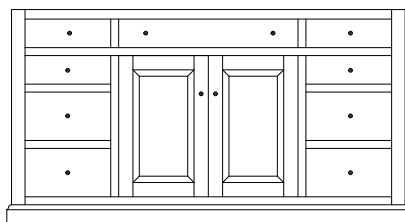

IS-78
62"w 34½"h 24"d
w/9 drawers 2 doors
w/1 adjustable shelf

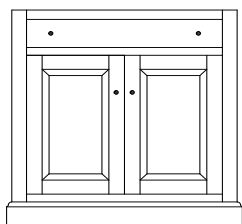

IS-79
32½"w 34½"h 18"d
w/1 drawer 2 doors
w/1 adjustable shelf

Standard Hardware



1¼" Wood Knobs

See the *Hardware & Stains* section for available hardware upgrades.



#4554
Sliding Shelf
replaces an
adjustable shelf



#4555
Mixer Lift
w/pullout shelf
(in place of regular
drawer and door)



#4559
Concealed Caster



#4561
Wine Rack
in place of door

Turned Leg Island Bases



IS-68



IS-69 R



IS-84



Shown with optional slideout wastebasket. IS-86



IS-94



IS-96



IS-98



Shown with optional slideout wastebasket. IS-99 L

Dress up your island with one of these specialty legs!

- A #4562 Fluted
- B #4563 Reeded
- C #4564 Diamond
- D #4565 Rope Twist

Specialty Leg Options

Available Feature Options



#4550
Slideout Wastebasket
w/2 wastebaskets



#4551
Tiltout Wastebasket
w/1 wastebasket



#4552
3 Tier Pullout



#4553
Pullout Cutting Board
w/hole cutout

Turned Leg Island Bases

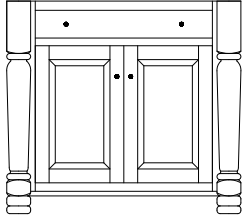

IS-68
37½"w 34½"h 24½"d
w/1 drawer 2 doors
w/1 adjustable shelf

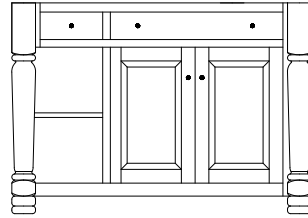

IS-69 L / IS-69 R
49"w 34½"h 24½"d
w/2 drawers, 2 doors
w/1 adjustable shelf, 1 open shelf

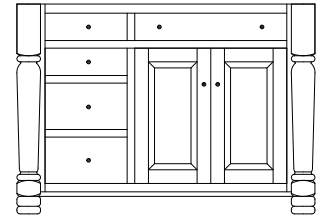

IS-84
49"w 34½"h 24½"d
w/5 drawers 2 doors
w/1 adjustable shelf

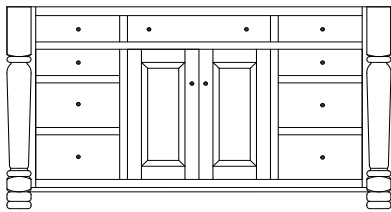

IS-86
61¾"w 34½"h 24½"d
w/9 drawers 2 doors
w/1 adjustable shelf

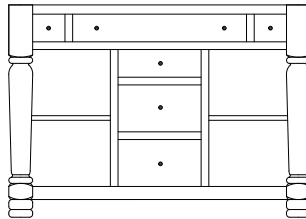

IS-94
49"w 34½"h 24½"d
w/6 drawers
w/2 open shelves

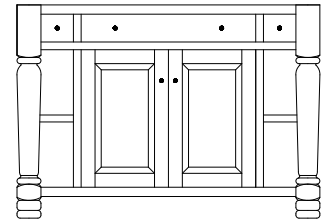

IS-96
49"w 34½"h 24½"d
w/3 drawers, 2 doors
w/1 adjustable shelf, 2 open shelves

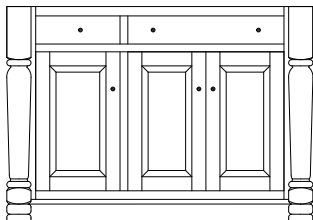

IS-98
49"w 34½"h 24½"d
w/2 drawers 3 doors
w/2 adjustable shelves

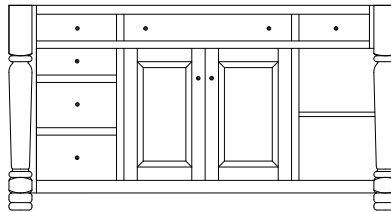

IS-99 L / IS-99 R
62"w 34½"h 24½"d
w/6 drawers 2 doors
w/1 adjustable shelf, 1 open shelf

Standard Hardware



1¼" Wood Knobs

See the *Hardware & Stains* section for available hardware upgrades.



#4554
Sliding Shelf
replaces an
adjustable shelf



#4555
Mixer Lift
w/pullout shelf
(in place of regular
drawer and door)



#4556
Wheel Caster
w/brake hidden by
adding skirting



#4557
3" Ball Caster
w/brake



#4561
Wine Rack
in place of door

Designer Series Island Bases



All bases come standard with:
Undermount Soft Close Slides & Soft Close Doors



Choose the Designer Series Island to perfectly fit your need in 3 easy steps:

Step 1: Island Layout

Step 2: Base Style

Step 3: Door/Drawer Style



DSB-240



DSB-245



Shown with optional
slideout wastebasket.

DSB-246

Step 2 (Base Style)



#50



#51



#52



#53



#54

Step 3 (Door/Drawer Style)



#35



#36



#37



#38



#39

Designer Series Island Bases

Step 1 (Island Layout)

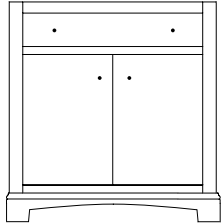

DSB-240
32½"w 34½"h 24½"d
w/1 drawer, 2 doors

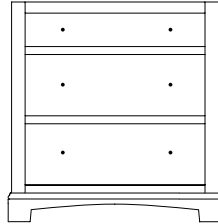

DSB-241
32½"w 34½"h 24½"d
w/3 drawers

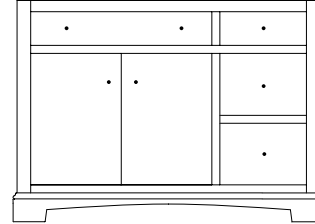

DSB-245
47¼"w 34½"h 24½"d
w/4 drawers, 2 doors

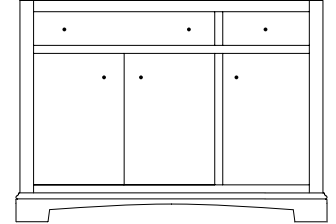

DSB-246
47¼"w 34½"h 24½"d
w/2 drawers, 3 doors

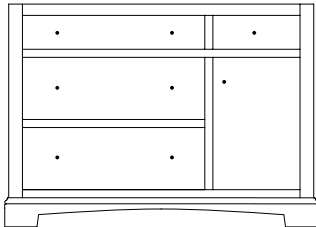

DSB-247
47¼"w 34½"h 24½"d
w/4 drawers, 1 door

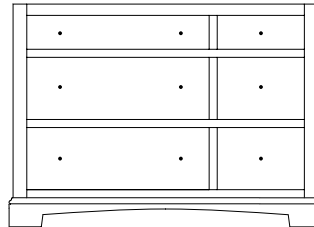

DSB-248
47¼"w 34½"h 24½"d
w/6 drawers

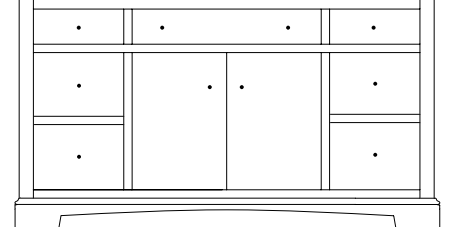

DSB-251
62"w 34½"h 24½"d
w/7 drawers, 2 doors

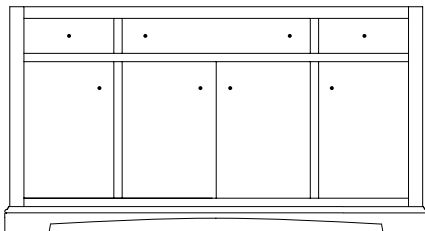

DSB-252
62"w 34½"h 24½"d
w/3 drawers, 4 doors

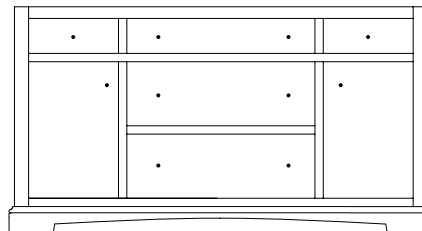

DSB-253
62"w 34½"h 24½"d
w/5 drawers, 2 doors

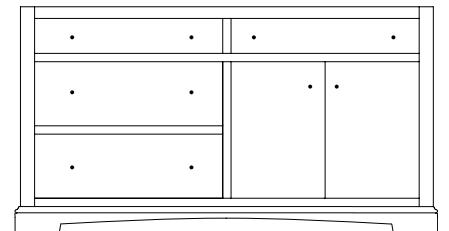

DSB-254
62"w 34½"h 24½"d
w/4 drawers, 2 doors

Available Feature Options



#4550
**Slideout
Wastebasket**
w/2 wastebaskets



#4572
**2 Tier
Pullout**



#4553
**Pullout
Cutting Board**
w/hole cutout



#4571
**Adjustable
Sliding Shelf**
replaces an
adjustable shelf



#4559
Concealed Caster



#4570
10" Leg Extension

Designer Series Turned Leg Island Bases



All bases come standard with:
Undermount Soft Close Slides & Soft Close Doors

Choose the Designer Series Island to perfectly fit your need in 3 easy steps:

Step 1: Island Layout

Step 2: Leg Style

Step 3: Door/Drawer Style



Shown with optional
slideout wastebasket.

DSL-747



Shown with table pullout
slideout wastebasket.

DSL-746



Shown with optional
slideout wastebasket.

DSL-753

Step 2 (Leg Style)

Step 3 (Door/Drawer Style)



#65 #66 #67 #68 #69



#35 #36 #37 #38 #39

Designer Series Turned Leg Island Bases

Step 1 (Island Layout)

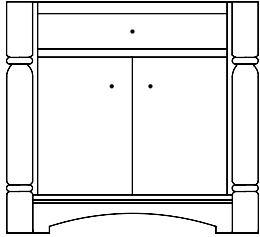

DSL-740
37½"w 34½"h 24½"d
w/1 drawer, 2 doors

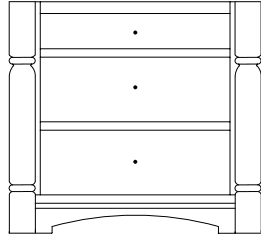

DSL-741
37½"w 34½"h 24½"d
w/3 drawers

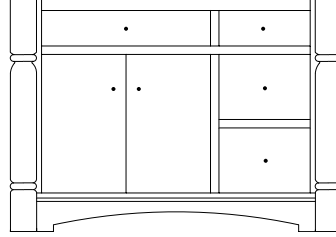

DSL-745
49"w 34½"h 24½"d
w/4 drawers, 2 doors

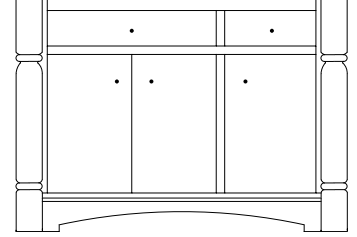

DSL-746
49"w 34½"h 24½"d
w/2 drawers, 3 doors

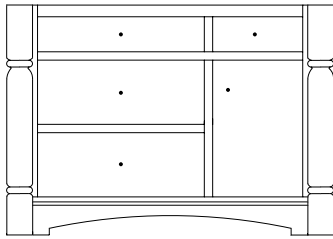

DSL-747
49"w 34½"h 24½"d
w/4 drawers, 1 door

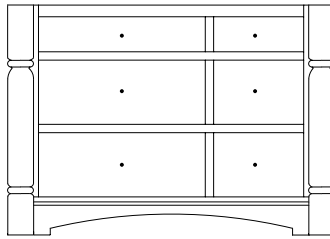

DSL-748
49"w 34½"h 24½"d
w/6 drawers

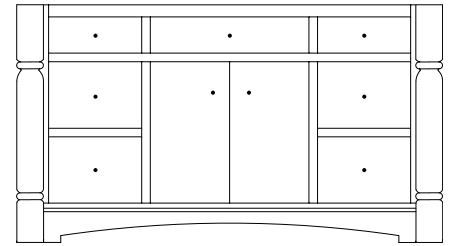

DSL-751
61¾"w 34½"h 24½"d
w/7 drawers, 2 doors

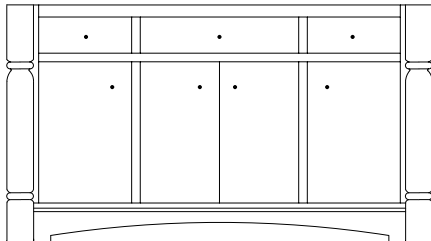

DSL-752
61¾"w 34½"h 24½"d
w/3 drawers, 4 doors

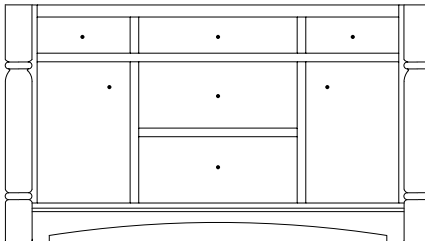

DSL-753
61¾"w 34½"h 24½"d
w/5 drawers, 2 doors

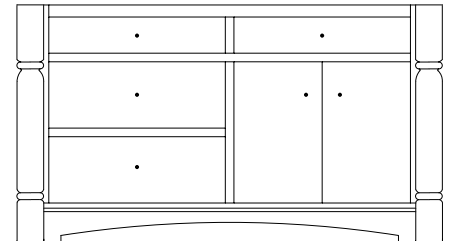

DSL-754
61¾"w 34½"h 24½"d
w/4 drawers, 2 doors

Available Feature Options



#4550
**Slideout
Wastebasket**
w/2 wastebaskets



#4572
**2 Tier
Pullout**



#4553
**Pullout
Cutting Board**
w/hole cutout



#4571
**Adjustable
Sliding Shelf**
replaces an
adjustable shelf



#4559
Concealed Caster



#4570
10" Leg Extension

Table Bases



Top is not included.
See available top options.

IS-5130 (Table Height)

2¼" Square Legs | 28¼"h

IS-5136 (Counter Height)

2¼" Square Legs | 34½"h

IS-5142 (Bar Height)

2¼" Square Legs | 40½"h



Top is not included.
See available top options.

IS-5230 (Table Height)

4" Square Legs | 28¼"h

IS-5236 (Counter Height)

4" Square Legs | 34½"h

IS-5242 (Bar Height)

4" Square Legs | 40½"h

Table Bases

IS-5330 (Table Height)

4" Turned Legs | 28¼"h

IS-5336 (Counter Height)

4" Turned Legs | 34½"h

IS-5342 (Bar Height)

4" Turned Legs | 40½"h



Top is not included.
See available top options.

IS-5430 (Table Height)

5" Constance Bay Legs | 28¼"h

IS-5436 (Counter Height)

5" Constance Bay Legs | 34½"h

IS-5442 (Bar Height)

5" Constance Bay Legs | 40½"h



Top is not included.
See available top options.

Table Pullouts



** Available on all Islands **



IS-1246



DSL-746

Table Pullouts



IS-808

Shown with Table Retracted.



IS-808

Shown with Table Pullout.



IS-808

Shown with
Table Pullout and Butterfly Leaf.

Wood & Steel Island Tops



1" Wood Top



Shown in Maple with rounded edges



Shown in Walnut with square edges

2" or 2" Butcher Block Tops
Rounded or Square Edges



2" Plank Glued Top



1 1/2" Reclaimed Barnwood Top



1 1/4" or 1 3/4" Rough Sawn Top



1 1/4" Stainless Steel Top

Available Feature Option:
Drop Leafs



Concrete & Granite Island Tops

Add 7" to 10" of overhang if using barstools at the island.



1 1/2" Concrete Top

Available Colors

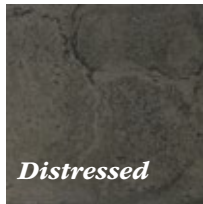

Distressed



White



Warm Gray



Taupe

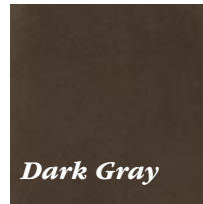

Dark Gray



1 1/4" Granite Top

Available Colors



Aspen White



Black Pearl

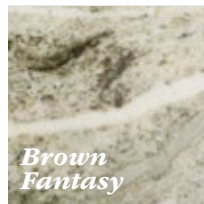

Brown Fantasy

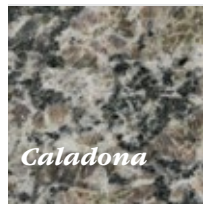

Caladona

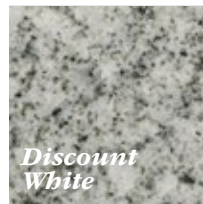

Discount White

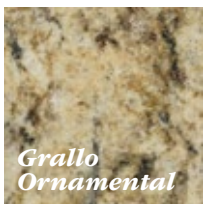

Grallo Ornamental

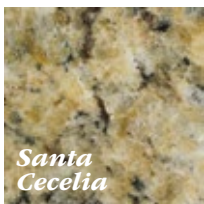

Santa Cecelia

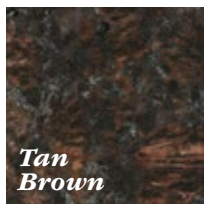

Tan Brown



Ubatuba

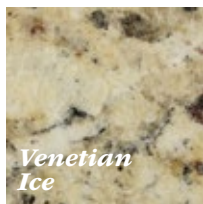

Venetian Ice

Island Extension Tops



Available Sizes

36" x 42" w/2 - 12" leaves

36" x 48" w/2 - 12" leaves

36" x 54" w/2 - 12" leaves

36" x 60" w/2 - 12" leaves
w/2 additional leaves

36" x 66" w/2 - 12" leaves
w/2 additional leaves

36" x 72" w/2 - 12" leaves
w/2 additional leaves

42" x 42" w/2 - 12" leaves

42" x 48" w/2 - 12" leaves

42" x 54" w/2 - 12" leaves

42" x 60" w/2 - 12" leaves
w/2 additional leaves

42" x 66" w/2 - 12" leaves
w/2 additional leaves

42" x 72" w/2 - 12" leaves
w/2 additional leaves

48" x 42" w/2 - 12" leaves

48" x 48" w/2 - 12" leaves

48" x 54" w/2 - 12" leaves

48" x 60" w/2 - 12" leaves
w/2 additional leaves

48" x 66" w/2 - 12" leaves
w/2 additional leaves

48" x 72" w/2 - 12" leaves
w/2 additional leaves

Island Extension Tops

