



NisleyTM

Cabinet, LLC

Wholesale Furniture Mfg.



Bedroom Collections | Occasional Tables | Kitchen Islands | Vanities



Bedroom Collections



Allentown | Barrington | Brookstone | Cabin Creek | Canyon Creek
Chelsea | Claremont Mission | Hamilton | Lewiston | Luellen | Manhattan
Olde Cottage | Regency | Rosedale | Shoreview | Sonora
Timber Mill | Wilkensburg





Allentown
Bedroom Collection

Allentown



Allentown Bedroom Collection w/ Allentown Bed

- AL-4017Q Queen Bed
- AL-4054 Dresser
- AL-4042 Night Stand
- MI-4030 Mirror
- AL-4063 Chest

Shown above in **Brown Maple** with # 4080 Base
OCS - 133 Tundra and **4318BRPW Hardware**

Standard Features:



4318BRPW Knobs



Standard with side-mount drawer slides

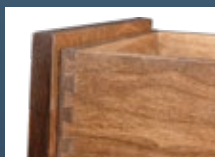

Stained poplar drawer boxes



Dovetailed bed slats

Available Upgrades:

- Any Hardware on our Hardware options sheet
- Undermount soft close slides [See Price List]

Base Options for Allentown



4080 Base



4081 Base



4082 Base

All units 3"
 Lower for
 Base # 4082

Allentown Night Stands



AL-4042
Night Stand shown

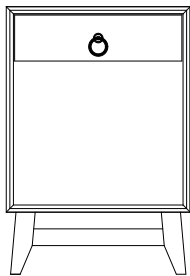

AL-4040 Night Stand
19¼"w 28"h 16½"d
w/1 drawer

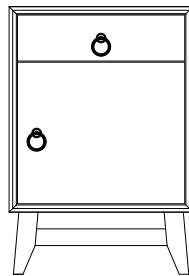

AL-4041 Night Stand
19¼"w 28"h 16½"d
w/1 drawer, 1 door

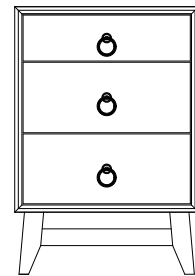

AL-4042 Night Stand
19¼"w 28"h 16½"d
w/3 drawers

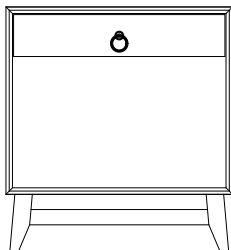

AL-4043 Night Stand
26"w 28"h 16½"d
w/1 drawer

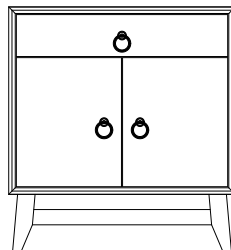

AL-4044 Night Stand
26"w 28"h 16½"d
w/1 drawer, 2 doors

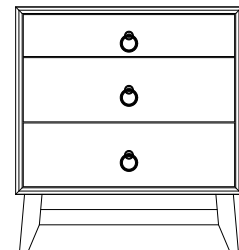

AL-4045 Night Stand
26"w 28"h 16½"d
w/3 drawers

Allentown Chests & Miscellaneous



AL-4063
Chest shown

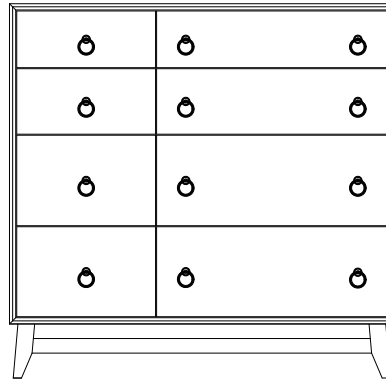

AL-4048 Chest
46¼"w 45"h 20"d
w/8 drawers

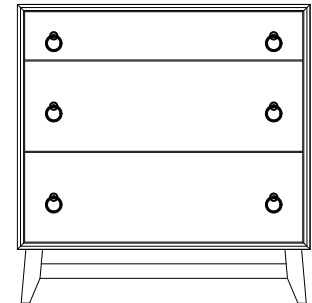

AL-4049 Chest
35¼"w 37"h 20"d
w/3 drawers

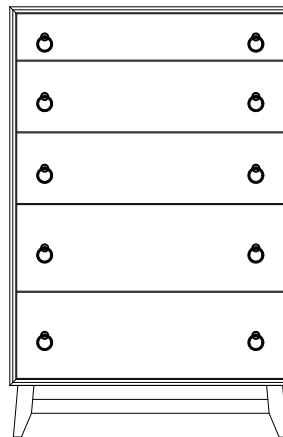

AL-4063 Chest
35¼"w 54"h 20"d
w/5 drawers

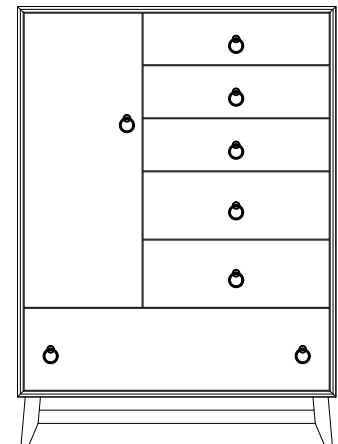

AL-4052 Chifferobe
42"w 58¼"h 20"d
w/6 drawers, 1 door,
2 adjustable shelves

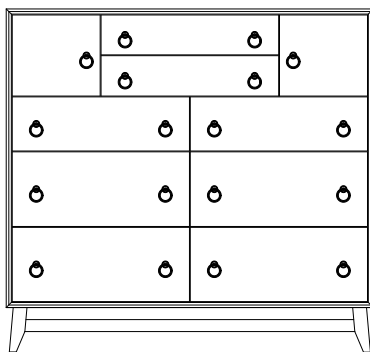

AL-4053 His & Hers
53½"w 50½"h 20"d
w/8 drawers, 2 doors

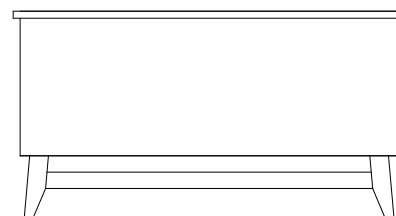

AL-4039 Blanket Chest
42"w 22"h 21½"d

Available
with aromatic
cedar bottom

Allentown Dressers



AL-4054 Dresser shown with MI-4030 Mirror

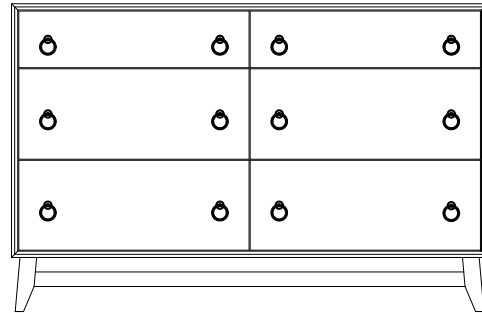

AL-4054
57¼"w 37"h 20"d
w/6 drawers

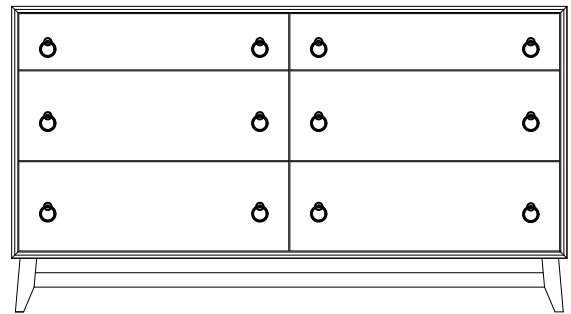

AL-4055
67¼"w 37"h 20"d
w/6 drawers

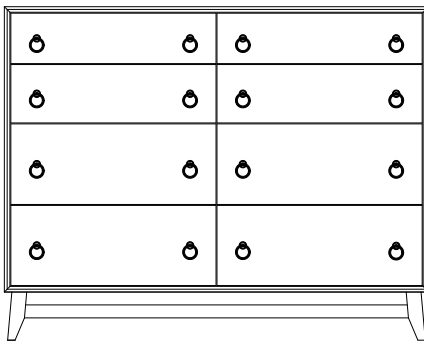

AL-4060
57¼"w 45"h 20"d
w/8 drawers

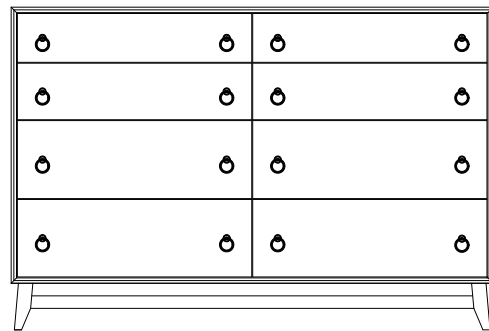

AL-4061
67¼"w 45"h 20"d
w/8 drawers

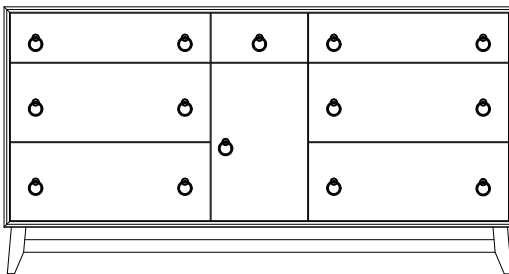

AL-4056
70¾"w 37"h 20"d
w/7 drawers, 1 door, 1 adjustable shelve



Plain Mirror

MI-4030 Mirror
40"h 36"w

MI-4031 Mirror
40"h 46"w

MI-4032 Mirror
32"h 42"w

MI-4033 Mirror
32"h 52"w

Allentown Bed Frames



shown with Regular Footboard

Allentown Bed

Regular Footboard

Available
with underbed
storage options.

AL-4017-K (King)
84 $\frac{5}{8}$ "w 87 $\frac{3}{4}$ "l
HB 48"h ■ FB 18"h

AL-4017-Q (Queen)
69"w 87 $\frac{3}{4}$ "l
HB 48"h ■ FB 18"h

AL-4017-F (Full)
61 $\frac{7}{8}$ "w 82 $\frac{3}{4}$ "l
HB 48"h ■ FB 18"h

AL-4017-T (Twin)
47"w 82 $\frac{3}{4}$ "l
HB 48"h ■ FB 18"h

Low Footboard

AL-4025-K (King)
84 $\frac{5}{8}$ "w 87 $\frac{3}{4}$ "l
HB 48"h ■ FB 14 $\frac{3}{4}$ "h

AL-4025-Q (Queen)
69"w 87 $\frac{3}{4}$ "l
HB 48"h ■ FB 14 $\frac{3}{4}$ "h

AL-4025-F (Full)
61 $\frac{7}{8}$ "w 82 $\frac{3}{4}$ "l
HB 48"h ■ FB 14 $\frac{3}{4}$ "h

AL-4025-T (Twin)
47"w 82 $\frac{3}{4}$ "l
HB 48"h ■ FB 14 $\frac{3}{4}$ "h

Headboard Only

AL-4033K-HB (King)
48" high

AL-4033Q-HB (Queen)
48" high

AL-4033F-HB (Full)
48" high

AL-4033T-HB (Twin)
48" high

Allentown Storage Rail Upgrades

12³/₄" From Floor to Box Spring

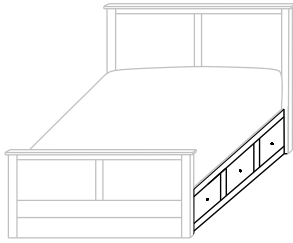

- With 3 drawers on each side
- 12³/₄" from floor to Box Spring
- Inside drawer dimensions on all sizes
9¹/₄"h 18⁷/₈"w 22¹/₂"d

532-SR-K King – 6 drawers
532-SR-Q Queen – 6 drawers
532-SR-F Full – 6 drawers
532-SR-T Twin – 3 drawers

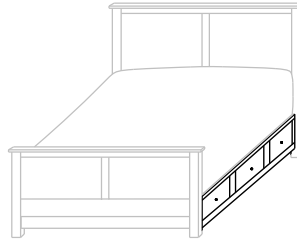

- With 3" Toe Kick
- With 3 drawers on each side
- 12³/₄" from floor to Box Spring
- Inside drawer dimensions on all sizes
6¹/₄"h 18⁷/₈"w 22¹/₂"d

234-SR-K King – 6 drawers
234-SR-Q Queen – 6 drawers
234-SR-F Full – 6 drawers
234-SR-T Twin – 3 drawers

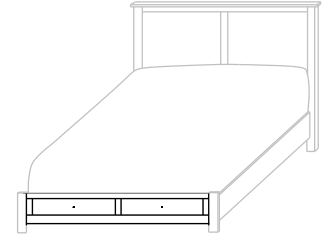

- 12³/₄" from floor to Box Spring
- Inside drawer dimensions
6¹/₄"h 22¹/₂"d
(King) 31"w (Queen) 23¹/₄"w
(Full) 19³/₈"w (Twin) 29¹/₄"w

685-FDS-K King – 2 drawers
685-FDS-Q Queen – 2 drawers
685-FDS-F Full – 2 drawers
685-FDS-T Twin – 1 drawer

19³/₄" From Floor to Box Spring

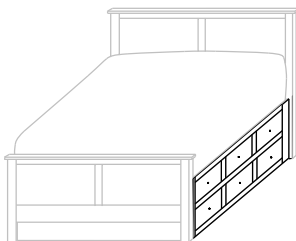

- With 6 drawers on each side
- Twin has 6 drawers on 1 side only
- 19³/₄" from floor to Box Spring
- Inside drawer dimensions on all sizes
6¹/₄"h 18⁷/₈"w 22¹/₂"d

654-SR-K King – 12 drawers
654-SR-Q Queen – 12 drawers
654-SR-F Full – 12 drawers
654-SR-T Twin – 6 drawers

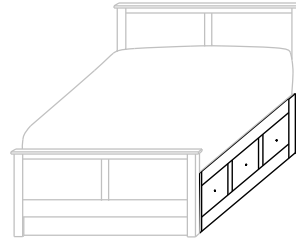

- With 3 drawers on each side
- 19³/₄" from floor to Box Spring
- Inside drawer dimensions on all sizes
10¹/₄"h 18⁷/₈"w 22¹/₂"d

325-SR-K King – 6 drawers
325-SR-Q Queen – 6 drawers
325-SR-F Full – 6 drawers
325-SR-T Twin – 3 drawers

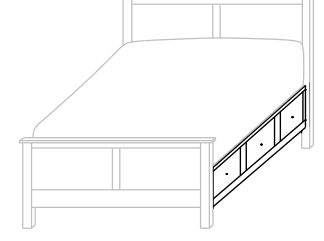

- With 7" Toe Kick
- With 3 drawers on each side
- 19³/₄" from floor to Box Spring
- Inside drawer dimensions on all sizes
9¹/₄"h 18⁷/₈"w 22¹/₂"d

236-SR-K King – 6 drawers
236-SR-Q Queen – 6 drawers
236-SR-F Full – 6 drawers
236-SR-T Twin – 3 drawers

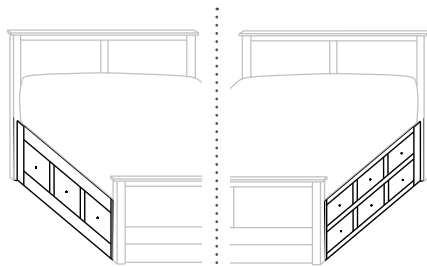

- With 3 drawers on one side and 6 drawers on other side
- 19³/₄" from floor to Box Spring

420-SR-K King – 9 drawers
420-SR-Q Queen – 9 drawers
420-SR-F Full – 9 drawers
(Twin Not Available)

Additional Upgrades

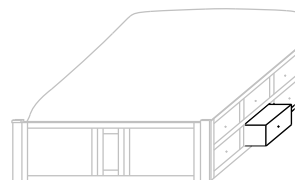

- With Step Stool Pullout in place of drawer

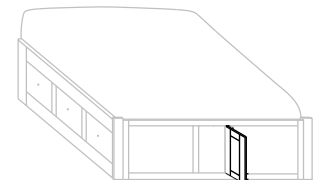

- With Door in Footboard to access area between rails





Barrington
Bedroom Collection

Barrington



Barrington Bedroom Collection w/Barrington Bed

- BR-1414Q Queen Bed
- BR-1354 Dresser
- BR-1340 Night Stand
- MI-1630 Mirror
- BR-1350 Chest

Shown above in **Brown Maple** with **OCS-121 Smoke** and **K272-SN Hardware**

Standard Features:



K 800-SN Knobs
K272-SN Pulls



Standard with side-mount drawer slides



Stained poplar dovetailed drawers



Dovetailed bed slats

Available Upgrades:

- Any hardware on our Hardware Options Sheet
- Undermount soft close slides [See Price List]



- ER-1930Q Elk Ridge Sleigh Bed
- BR-1345 Night Stand
- BR-1363 Chest
- BR-1360 Dresser
- MI-1632 Mirror

Shown in **Brown Maple** with **FC-19093 Dark Knight** and **24017-SN Hardware**

Barrington Night Stands



BR-1340
Night Stand shown

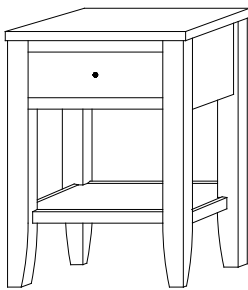

BR-1340 Night Stand
19¾"w 28"h 17"d
w/1 drawer

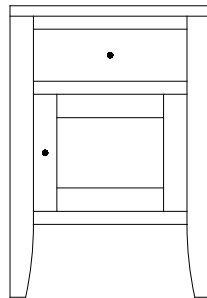

BR-1341 Night Stand
19¼"w 28"h 16½"d
w/1 drawer, 1 door

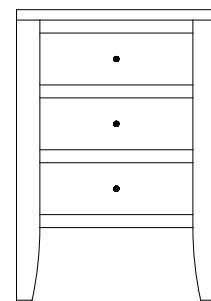

BR-1342 Night Stand
19¼"w 28"h 16½"d
w/3 drawers

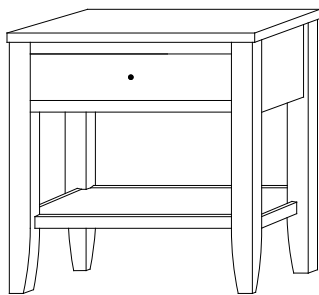

BR-1343 Night Stand
26½"w 28"h 17"d
w/1 drawer

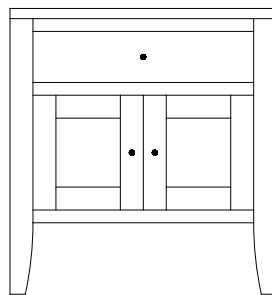

BR-1344 Night Stand
26"w 28"h 16½"d
w/1 drawer, 2 doors

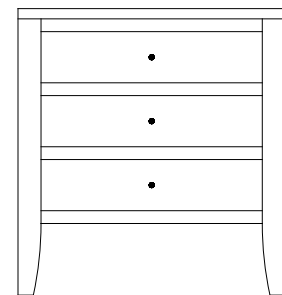

BR-1345 Night Stand
26"w 28"h 16½"d
w/3 drawers

Barrington Lingeries & Chests



BR-1350
Chest shown

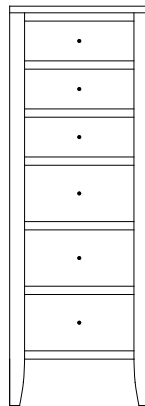

BR-1346 Lingerie
21"w 60¼"h 20½"d
w/6 drawers

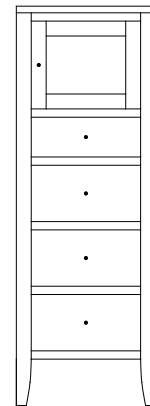

Available with
mirror panel
in door

BR-1347 Lingerie
21"w 60¼"h 20½"d
w/4 drawers, 1 wood
door, 1 adjustable shelf

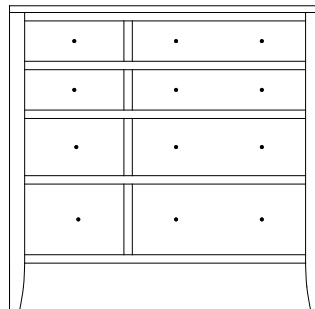

BR-1348 Chest
46¼"w 45¼"h 20½"d
w/8 drawers

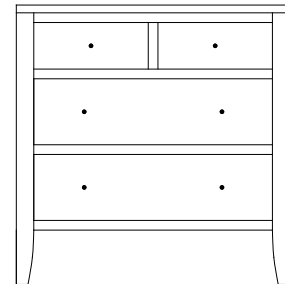

BR-1349 Chest
35¼"w 36"h 20½"d
w/4 drawers

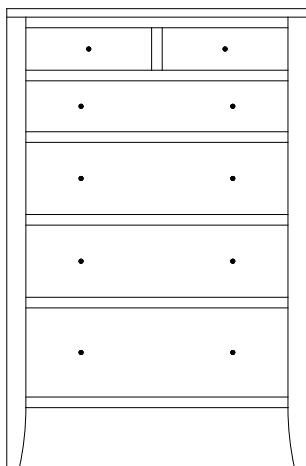

BR-1350 Chest
35¼"w 54"h 20½"d
w/6 drawers

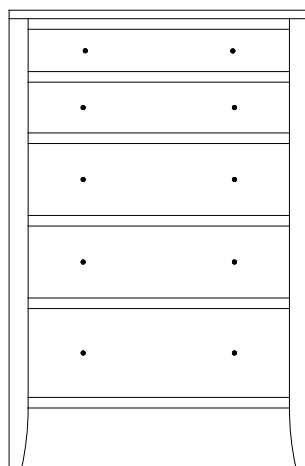

BR-1363 Chest
35¼"w 54"h 20½"d
w/5 drawers

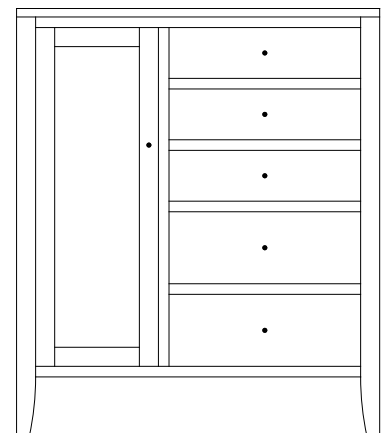

BR-1351 Door Chest
42¾"w 50½"h 20½"d
w/5 drawers, 1 door

Barrington Miscellaneous

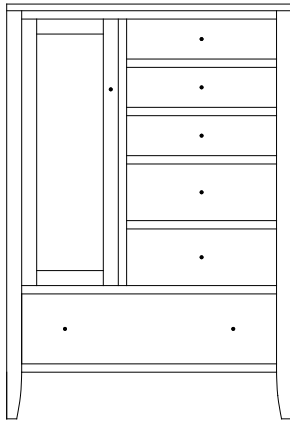

Option:
Mirror on
back of door

BR-1352 Chifferobe
42³/₄"w 62¹/₄"h 20¹/₂"d
w/6 drawers, 1 door, 2 adj. shelves

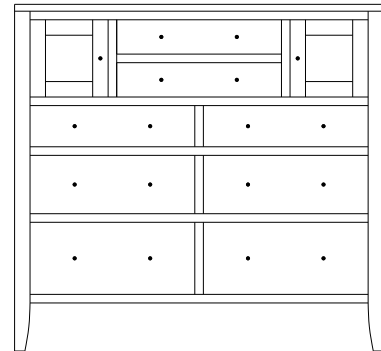

BR-1353 His & Hers
55³/₄"w 50¹/₂"h 20¹/₂"d
w/8 drawers, 2 doors

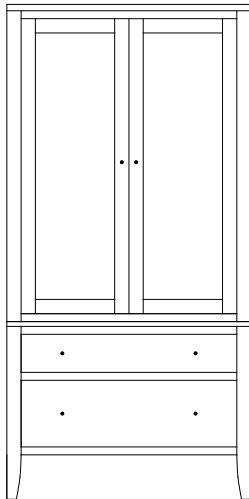

BR-1362 Armoire
38¹/₂"w 78"h 20¹/₂"d
w/2 drawers, (top drawer w/divider)
w/2 doors, 2 adj. shelves & closet rod

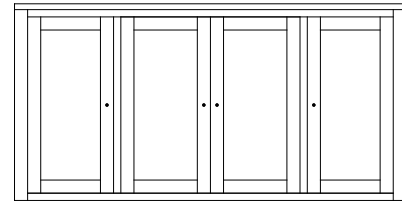

BR-1359 Mule Chest Top
67¹/₄"w 33¹/₄"h 20¹/₂"d
w/4 doors & 6 adjustable shelves

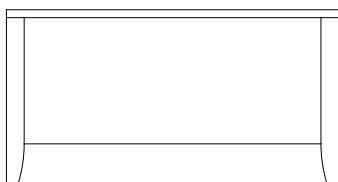

BR-1339 Blanket Chest
41"w 22"h 21"d

Available
with aromatic
cedar bottom

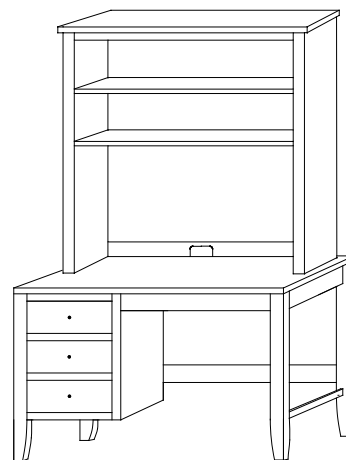

BR-1397 Study Carrel
48"w 42"h 13"d
w/2 adjustable shelves

BR-1399 Student Desk
46"w 29¹/₂"h 21¹/₂"d
w/3 drawers
w/1 pencil drawer

Upgrades available on student desk:

Keyboard slideout instead of pencil drawer
File drawer instead of bottom 2 drawers

Barrington Dressers



BR-1354 Dresser shown with MI-1630 Mirror

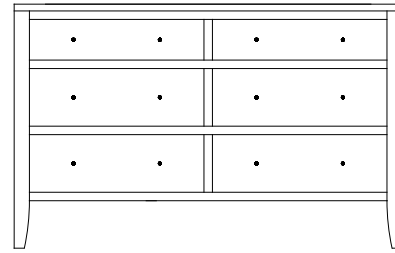

BR-1354 Dresser
57¼"w 36"h 20½"d
w/6 drawers

Suggested Mirrors:

MI-1630 Mirror
40"h 36"w

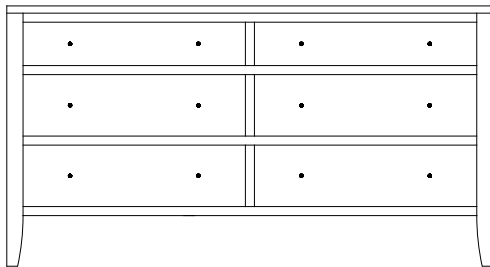

BR-1355 Dresser
67¼"w 36"h 20½"d
w/6 drawers

Suggested Mirrors:

MI-1631 Mirror
40"h 46"w

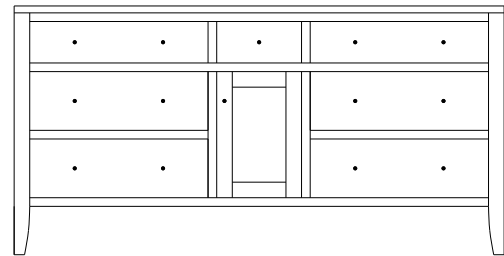

BR-1356 Dresser
70¾"w 36"h 20½"d
w/7 drawers, 1 door
w/1 adjustable shelf

Suggested Mirrors:

MI-1631 Mirror
40"h 46"w

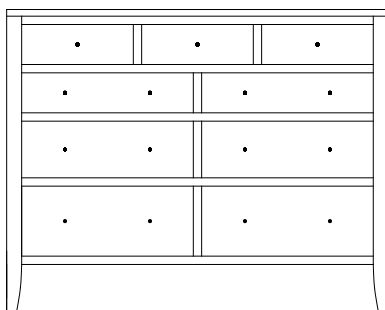

BR-1357 Dresser
57¼"w 45¼"h 20½"d
w/9 drawers

Suggested Mirrors:

MI-1632 Mirror
32"h 42"w

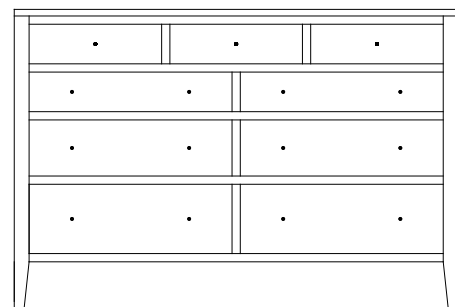

BR-1358 Dresser
67¼"w 45¼"h 20½"d
w/9 drawers

Suggested Mirrors:

MI-1633 Mirror
32"h 52"w

Barrington Dressers

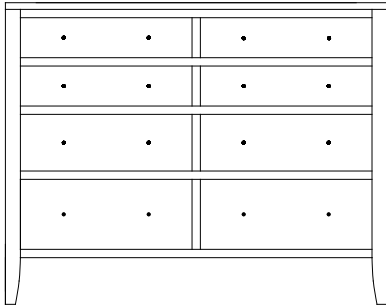

BR-1360 Dresser
57¼"w 45¼"h 20½"d
w/8 drawers

Suggested Mirrors:

MI-1632 Mirror
32"h 42"w

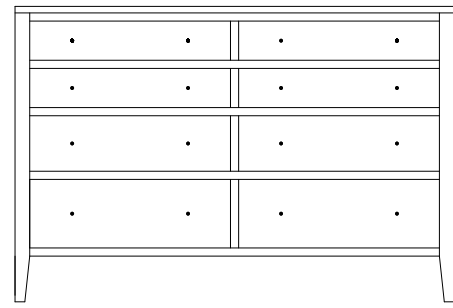

BR-1361 Dresser
67¼"w 45¼"h 20½"d
w/8 drawers

Suggested Mirrors:

MI-1633 Mirror
32"h 52"w

Barrington Mirrors



Beveled Mirror

MI-1630 Mirror
40"high 36"wide

MI-1631 Mirror
40"high 46"wide

MI-1632 Mirror
32"high 42"wide

MI-1633 Mirror
32"high 52"wide

Barrington Bed Frames



Shown with Low Footboard



Shown with Low Footboard

234-SR
Storage
Upgrade

Barrington Bed w/Wood Panels

Available
with underbed
storage options.

Regular Footboard

BR-1414-K (King)
78 $\frac{3}{8}$ "w 84 $\frac{1}{2}$ "l
HB 54"h ■ FB 30"h

BR-1414-Q (Queen)
63 $\frac{1}{8}$ "w 84 $\frac{1}{2}$ "l
HB 54"h ■ FB 30"h

BR-1414-F (Full)
55 $\frac{7}{8}$ "w 79 $\frac{1}{2}$ "l
HB 54"h ■ FB 30"h

BR-1414-T (Twin)
41"w 79 $\frac{1}{2}$ "l
HB 54"h ■ FB 30"h

Low Footboard

BR-1422-K (King)
78 $\frac{3}{8}$ "w 84 $\frac{1}{2}$ "l
HB 54"h ■ FB 14 $\frac{3}{4}$ "h

BR-1422-Q (Queen)
63 $\frac{1}{8}$ "w 84 $\frac{1}{2}$ "l
HB 54"h ■ FB 14 $\frac{3}{4}$ "h

BR-1422-F (Full)
55 $\frac{7}{8}$ "w 79 $\frac{1}{2}$ "l
HB 54"h ■ FB 14 $\frac{3}{4}$ "h

BR-1422-T (Twin)
41"w 79 $\frac{1}{2}$ "l
HB 54"h ■ FB 14 $\frac{3}{4}$ "h

Headboard Only

BR-1430K-HB (King)
54" high

BR-1430Q-HB (Queen)
54" high

BR-1430F-HB (Full)
54" high

BR-1430T-HB (Twin)
54" high

Elk Ridge Sleigh Bed

Available
with underbed
storage options.

Regular Footboard

ER-1930-K (King)
79 $\frac{3}{8}$ "w 93"l
HB 59"h ■ FB 30"h

ER-1930-Q (Queen)
64"w 93"l
HB 59"h ■ FB 30"h

ER-1930-F (Full)
56 $\frac{7}{8}$ "w 88"l
HB 59"h ■ FB 30"h

ER-1930-T (Twin)
42"w 88"l
HB 59"h ■ FB 30"h

Low Footboard

ER-1932-K (King)
79 $\frac{3}{8}$ "w 88 $\frac{3}{4}$ "l
HB 59"h ■ FB 14 $\frac{3}{4}$ "h

ER-1932-Q (Queen)
64"w 88 $\frac{3}{4}$ "l
HB 59"h ■ FB 14 $\frac{3}{4}$ "h

ER-1932-F (Full)
56 $\frac{7}{8}$ "w 83 $\frac{3}{4}$ "l
HB 59"h ■ FB 14 $\frac{3}{4}$ "h

ER-1932-T (Twin)
42"w 83 $\frac{3}{4}$ "l
HB 59"h ■ FB 14 $\frac{3}{4}$ "h

Headboard Only

ER-1940K-HB (King)
59" high

ER-1940Q-HB (Queen)
59" high

ER-1940F-HB (Full)
59" high

ER-1940T-HB (Twin)
59" high

Barrington Storage Rail Upgrades

12³/₄" From Floor to Box Spring

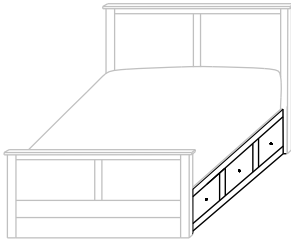

- With 3 drawers on each side
- 12³/₄" from floor to Box Spring
- Inside drawer dimensions on all sizes
9¹/₄"h 18⁷/₈"w 22¹/₂"d

532-SR-K King – 6 drawers
532-SR-Q Queen – 6 drawers
532-SR-F Full – 6 drawers
532-SR-T Twin – 3 drawers

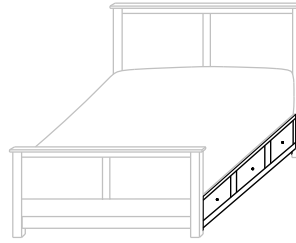

- With 3" Toe Kick
- With 3 drawers on each side
- 12³/₄" from floor to Box Spring
- Inside drawer dimensions on all sizes
6¹/₄"h 18⁷/₈"w 22¹/₂"d

234-SR-K King – 6 drawers
234-SR-Q Queen – 6 drawers
234-SR-F Full – 6 drawers
234-SR-T Twin – 3 drawers

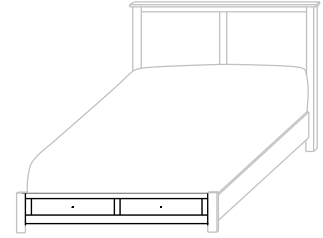

- 12³/₄" from floor to Box Spring
- Inside drawer dimensions
6¹/₄"h 22¹/₂"d
 (King) 31" w (Queen) 23¹/₄" w
 (Full) 19⁵/₈" w (Twin) 29¹/₄" w

685-FDS-K King – 2 drawers
685-FDS-Q Queen – 2 drawers
685-FDS-F Full – 2 drawers
685-FDS-T Twin – 1 drawer

19³/₄" From Floor to Box Spring

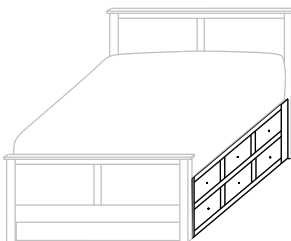

- With 6 drawers on each side
- Twin has 6 drawers on 1 side only
- 19³/₄" from floor to Box Spring
- Inside drawer dimensions on all sizes
6¹/₄"h 18⁷/₈"w 22¹/₂"d

654-SR-K King – 12 drawers
654-SR-Q Queen – 12 drawers
654-SR-F Full – 12 drawers
654-SR-T Twin – 6 drawers

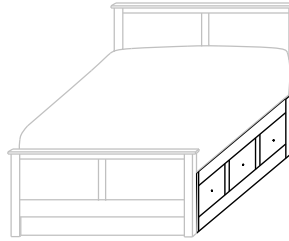

- With 3 drawers on each side
- 19³/₄" from floor to Box Spring
- Inside drawer dimensions on all sizes
10¹/₄"h 18⁷/₈"w 22¹/₂"d

325-SR-K King – 6 drawers
325-SR-Q Queen – 6 drawers
325-SR-F Full – 6 drawers
325-SR-T Twin – 3 drawers

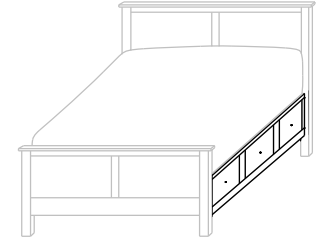

- With 7" Toe Kick
- With 3 drawers on each side
- 19³/₄" from floor to Box Spring
- Inside drawer dimensions on all sizes
9¹/₄"h 18⁷/₈"w 22¹/₂"d

236-SR-K King – 6 drawers
236-SR-Q Queen – 6 drawers
236-SR-F Full – 6 drawers
236-SR-T Twin – 3 drawers

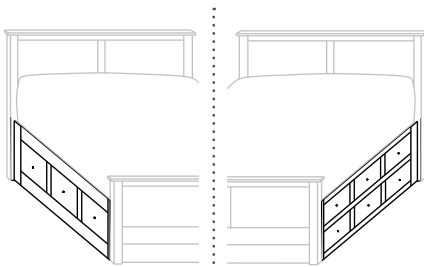

- With 3 drawers on one side and 6 drawers on other side
- 19³/₄" from floor to Box Spring

420-SR-K King – 9 drawers
420-SR-Q Queen – 9 drawers
420-SR-F Full – 9 drawers
 (Twin Not Available)

Additional Upgrades



- With Step Stool Pullout in place of drawer

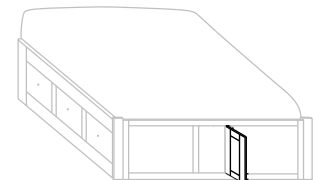

- With Door in Footboard to access area between rails





Brookstone
Bedroom Collection

Brookstone



Brookstone Bedroom Collection

- BK-2865Q Queen Bed
- BK-2842 Night Stand
- BK-2850 Chest
- BK-2858 Dresser
- MI-2833 Mirror

Shown above in **QWO** with **OCS-113 Michael's KR15 Black Hardware w/ Optional Black Rope & Base Trim**

Standard Features:



K810-MB Knobs



Standard with side-mount drawer slides

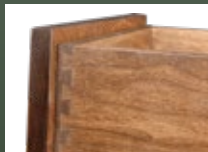

Stained poplar dovetailed drawers



Dovetailed bed slats

Available Upgrades:

- Any hardware on our Hardware Options Sheet
- Black Rope & Base Trim
- Undermount soft close slides [See Price List]



- BK-2865Q Queen Bed
- BK-2842 Night Stand
- BK-2850 Chest
- BK-2858 Dresser
- MI-2833 Mirror

Shown in **Rustic QWO** with **OCS-136 Graystone** and **K810-MB Hardware**

Brookstone Night Stands



BK-2842
Night Stand shown

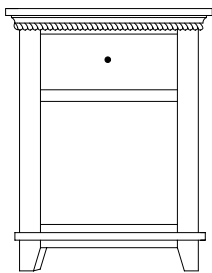

BK-2840 Night Stand
21 $\frac{3}{4}$ "w 28 $\frac{1}{4}$ "h 17 $\frac{3}{4}$ "d
w/1 drawer

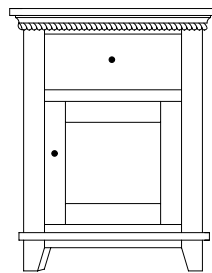

BK-2841 Night Stand
21 $\frac{3}{4}$ "w 28 $\frac{1}{4}$ "h 17 $\frac{3}{4}$ "d
w/1 drawer, 1 door

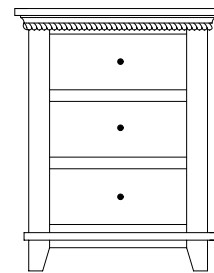

BK-2842 Night Stand
21 $\frac{3}{4}$ "w 28 $\frac{1}{4}$ "h 17 $\frac{3}{4}$ "d
w/3 drawers

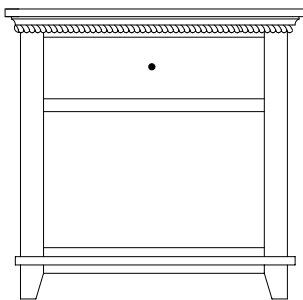

BK-2843 Night Stand
28 $\frac{1}{2}$ "w 28 $\frac{1}{4}$ "h 17 $\frac{3}{4}$ "d
w/1 drawer

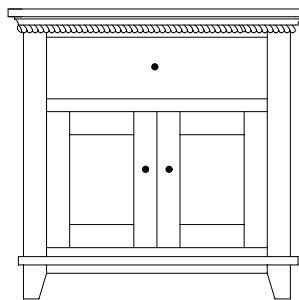

BK-2844 Night Stand
28 $\frac{1}{2}$ "w 28 $\frac{1}{4}$ "h 17 $\frac{3}{4}$ "d
w/1 drawer, 2 doors

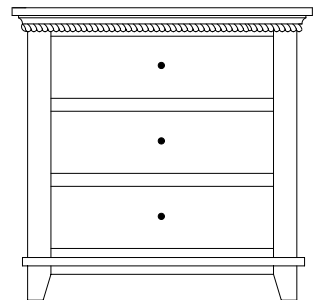

BK-2845 Night Stand
28 $\frac{1}{2}$ "w 28 $\frac{1}{4}$ "h 17 $\frac{3}{4}$ "d
w/3 drawers

Brookstone Lingeries & Chests

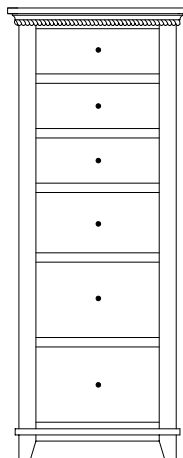

BK-2846 Lingerie
23³/₈"w 60"h 21³/₄"d
w/6 drawers

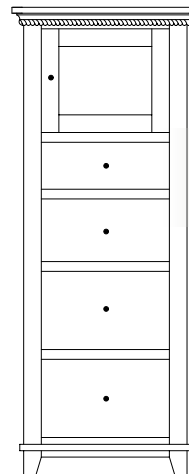

Available with
mirror in
door panel

BK-2847 Lingerie
23³/₈"w 60"h 21³/₄"d
w/4 drawers, 1 wood door,
1 adjustable shelf

BK-2850
Chest shown



BK-2849 Chest
37³/₄"w 36¹/₄"h 21³/₄"d
w/4 drawers

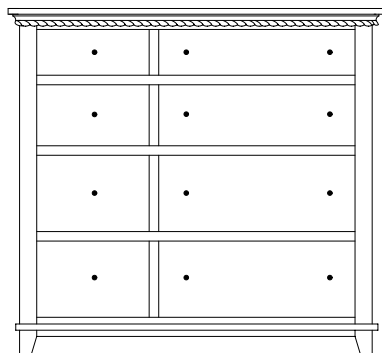

BK-2848 Chest
48³/₄"w 45¹/₂"h 21³/₄"d
w/8 drawers

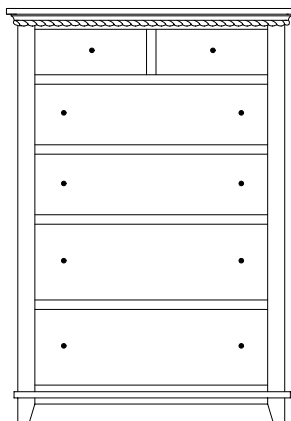

BK-2850 Chest
37³/₄"w 54³/₄"h 21³/₄"d
w/6 drawers

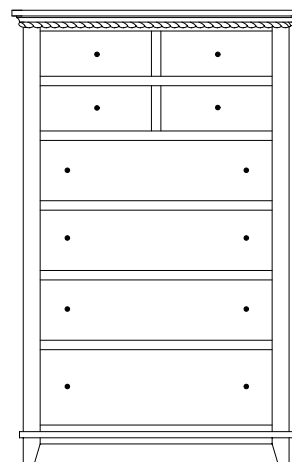

BK-2851 Hi-Boy
37³/₄"w 60"h 21³/₄"d
w/8 drawers

Brookstone Miscellaneous

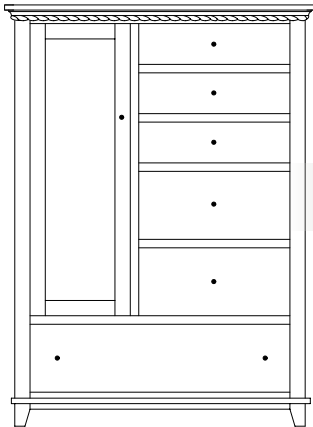

Option:
Mirror on
back of door

BK-2852 Chifferobe
45¼"w 62"h 21¾"d
w/6 drawers, 1 door, 2 adj. shelves

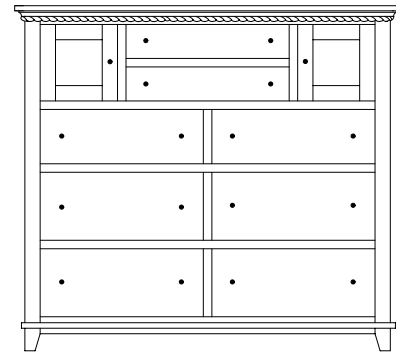

BK-2853 His & Hers Chest
56¼"w 50¾"h 21¾"d
w/8 drawers, 2 doors

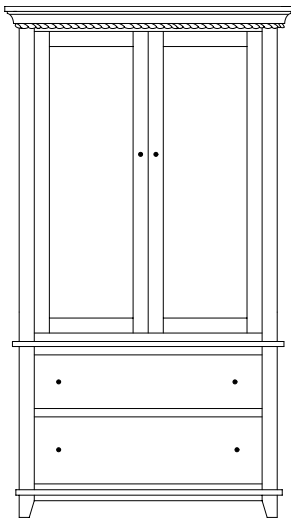

BK-2862 Armoire
42"w 76¼"h 22¼"d
w/2 drawers, w/2 doors,
2 adj. shelves & closet rod

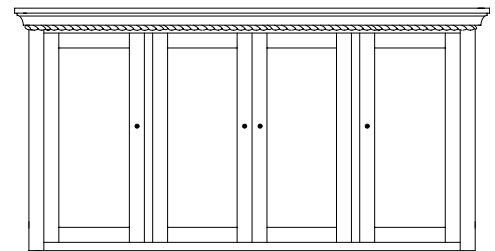

BK-2859 Mule Chest Top
70¾"w 36½"h 22¼"d
w/4 doors & 6 adjustable shelves

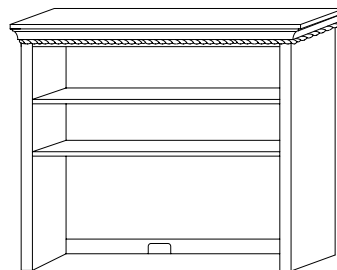

BK-2897 Study Carrel
49½"w 42"h 13¾"d
w/2 adjustable shelves

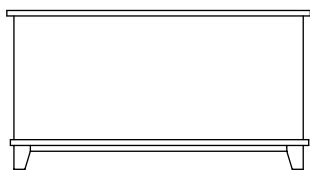

BK-2835 Blanket Chest
42"w 22"h 21½"d

Available
with aromatic
cedar bottom

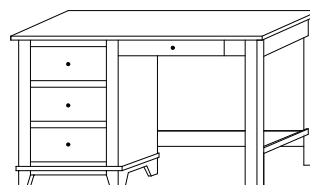

BK-2899 Student Desk
48"w 29"h 23"d
w/3 drawers
w/1 pencil drawer

Upgrades available on student desk:

Keyboard slideout instead of pencil drawer
File drawer instead of bottom 2 drawers

Brookstone Dressers



BK-2858 Dresser shown with **MI-2833** Mirror

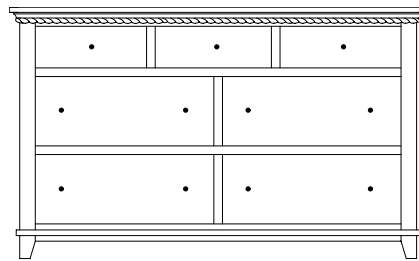

BK-2854 Dresser
59 $\frac{3}{4}$ "w 36 $\frac{1}{4}$ "h 21 $\frac{3}{4}$ "d
w/7 drawers

Suggested Mirrors:

MI-2830 Mirror
40"h 37"w

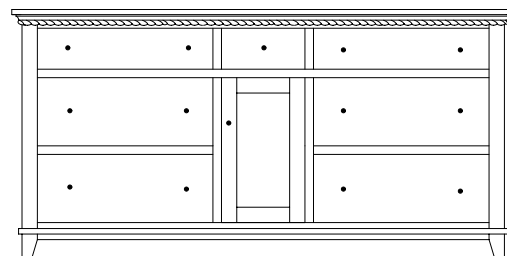

BK-2856 Dresser
73 $\frac{1}{4}$ "w 36 $\frac{1}{4}$ "h 21 $\frac{3}{4}$ "d
w/7 drawers, 1 door
w/1 adjustable shelf

Suggested Mirrors:

MI-2831 Mirror
40"h 47"w

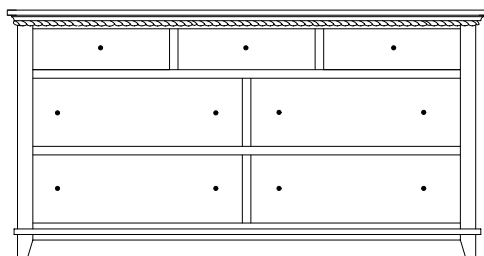

BK-2855 Dresser
69 $\frac{3}{4}$ "w 36 $\frac{1}{4}$ "h 21 $\frac{3}{4}$ "d
w/7 drawers

Suggested Mirrors:

MI-2831 Mirror
40"h 47"w

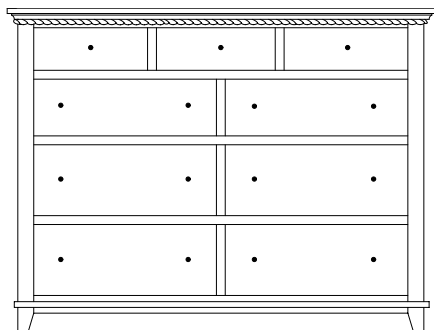

BK-2857 Dresser
59 $\frac{3}{4}$ "w 45 $\frac{1}{2}$ "h 21 $\frac{3}{4}$ "d
w/9 drawers

Suggested Mirrors:

MI-2832 Mirror
32"h 43"w

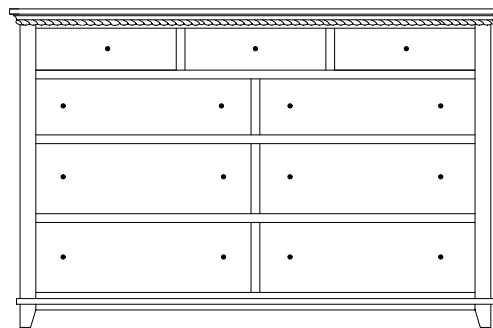

BK-2858 Dresser
69 $\frac{3}{4}$ "w 45 $\frac{1}{2}$ "h 21 $\frac{3}{4}$ "d
w/9 drawers

Suggested Mirrors:

MI-2833 Mirror
32"h 53"w

Brookstone Mirrors



MI-2830 Mirror
40"h 37"w

MI-2831 Mirror
40"h 47"w

MI-2832 Mirror
32"h 43"w

MI-2833 Mirror
32"h 53"w

Beveled Mirror

Brookstone Bed Frames



shown with Regular Footboard

Brookstone Bed

Regular Footboard

Available
with underbed
storage options.

BK-2865-K (King)
82⁵/₈"w 89"l
HB 55¹/₄"h ■ FB 34"h

BK-2865-Q (Queen)
67"w 89"l
HB 55¹/₄"h ■ FB 34"h

BK-2865-F (Full)
59⁷/₈"w 84"l
HB 55¹/₄"h ■ FB 34"h

BK-2865-T (Twin)
45"w 84"l
HB 55¹/₄"h ■ FB 34"h

Low Footboard

BK-2866-K (King)
82⁵/₈"w 87¹/₄"l
HB 55¹/₄"h ■ FB 14³/₄"h

BK-2866-Q (Queen)
67"w 87¹/₄"l
HB 55¹/₄"h ■ FB 14³/₄"h

BK-2866-F (Full)
59⁷/₈"w 82¹/₄"l
HB 55¹/₄"h ■ FB 14³/₄"h

BK-2866-T (Twin)
45"w 82¹/₄"l
HB 55¹/₄"h ■ FB 14³/₄"h

Headboard Only

BK-2867K-HB (King)
55¹/₄" high

BK-2867Q-HB (Queen)
55¹/₄" high

BK-2867F-HB (Full)
55¹/₄" high

BK-2867T-HB (Twin)
48" high

Brookstone Storage Rail Upgrades

12³/₄" From Floor to Box Spring

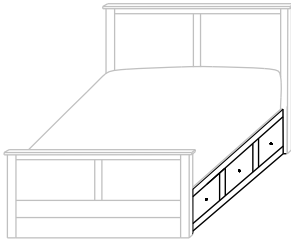

- With 3 drawers on each side
- 12³/₄" from floor to Box Spring
- Inside drawer dimensions on all sizes
9¹/₄"h 18⁷/₈"w 22¹/₂"d

532-SR-K King – 6 drawers
532-SR-Q Queen – 6 drawers
532-SR-F Full – 6 drawers
532-SR-T Twin – 3 drawers

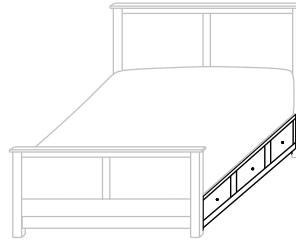

- With 3" Toe Kick
- With 3 drawers on each side
- 12³/₄" from floor to Box Spring
- Inside drawer dimensions on all sizes
6¹/₄"h 18⁷/₈"w 22¹/₂"d

234-SR-K King – 6 drawers
234-SR-Q Queen – 6 drawers
234-SR-F Full – 6 drawers
234-SR-T Twin – 3 drawers

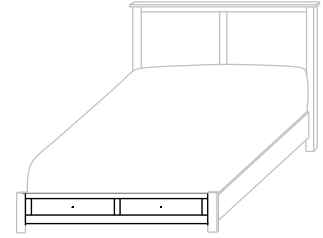

- 12³/₄" from floor to Box Spring
- Inside drawer dimensions
6¹/₄"h 22¹/₂"d
 (King) 31" w (Queen) 23¹/₄" w
 (Full) 19⁵/₈" w (Twin) 29¹/₄" w

685-FDS-K King – 2 drawers
685-FDS-Q Queen – 2 drawers
685-FDS-F Full – 2 drawers
685-FDS-T Twin – 1 drawer

19³/₄" From Floor to Box Spring

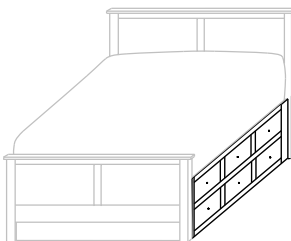

- With 6 drawers on each side
- Twin has 6 drawers on 1 side only
- 19³/₄" from floor to Box Spring
- Inside drawer dimensions on all sizes
6¹/₄"h 18⁷/₈"w 22¹/₂"d

654-SR-K King – 12 drawers
654-SR-Q Queen – 12 drawers
654-SR-F Full – 12 drawers
654-SR-T Twin – 6 drawers

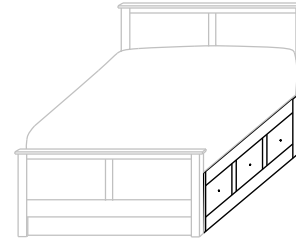

- With 3 drawers on each side
- 19³/₄" from floor to Box Spring
- Inside drawer dimensions on all sizes
10¹/₄"h 18⁷/₈"w 22¹/₂"d

325-SR-K King – 6 drawers
325-SR-Q Queen – 6 drawers
325-SR-F Full – 6 drawers
325-SR-T Twin – 3 drawers

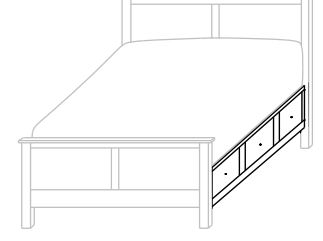

- With 7" Toe Kick
- With 3 drawers on each side
- 19³/₄" from floor to Box Spring
- Inside drawer dimensions on all sizes
9¹/₄"h 18⁷/₈"w 22¹/₂"d

236-SR-K King – 6 drawers
236-SR-Q Queen – 6 drawers
236-SR-F Full – 6 drawers
236-SR-T Twin – 3 drawers

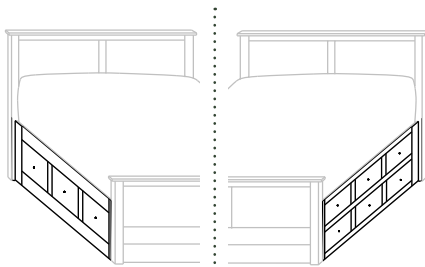

- With 3 drawers on one side and 6 drawers on other side
- 19³/₄" from floor to Box Spring

420-SR-K King – 9 drawers
420-SR-Q Queen – 9 drawers
420-SR-F Full – 9 drawers
 (Twin Not Available)

Additional Upgrades

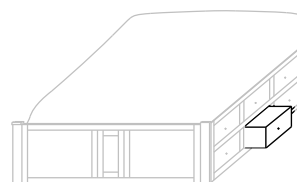

- With Step Stool Pullout in place of drawer

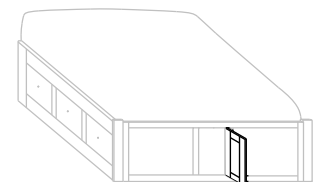

- With Door in Footboard to access area between rails





Cabin Creek
Bedroom Collection

Cabin Creek



Cabin Creek Bedroom Collection w/Dreamland Bed

- PI-1124Q Prairie Bed w/685-FDS Storage Upgrade
- CA-542 Night Stand
- CA-551 Chest
- CA-558 Dresser
- MI-1733 Mirror

Shown above in **Brown Maple** with **OCS-117 Asbury** and **K3489-SN Hardware**

Standard Features:



1 1/2" Wood Knobs



Standard with side-mount drawer slides

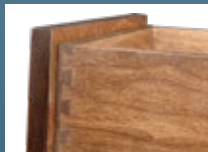

Stained poplar drawer boxes



Dovetailed bed slats

Available Upgrades:

- Any hardware on our Hardware Options Sheet
- Undermount soft close slides [See Price List]
- Rough sawn tops [See Price List]

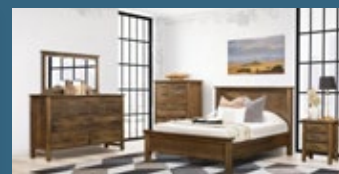

- CA-564Q Queen Bed
- CA-542 Night Stand
- CA-551 Hi-Boy
- CA-558 Dresser
- MI-1733 Mirror

Shown in **Brown Maple** with **FC-47874 Stockton** and **K558-SI Hardware**

Cabin Creek Night Stands



CA-542
Night Stand shown



Sliding top option available on all night stands
(Hidden compartment w/Lock)

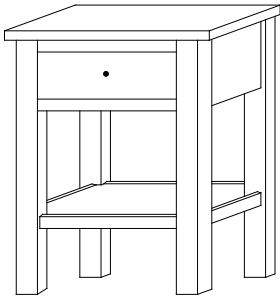

CA-540 Night Stand
21¼"w 28"h 18½"d
w/1 drawer

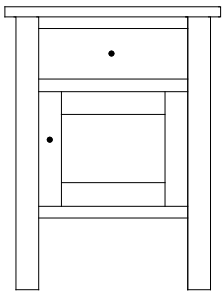

CA-541 Night Stand
21¼"w 28"h 17½"d
w/1 drawer, 1 door

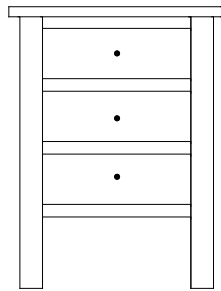

CA-542 Night Stand
21¼"w 28"h 17½"d
w/3 drawers

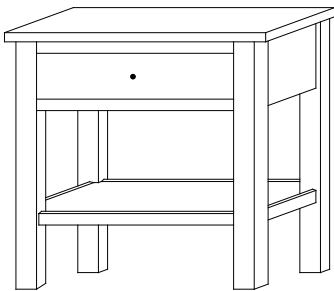

CA-543 Night Stand
28"w 28"h 18½"d
w/1 drawer

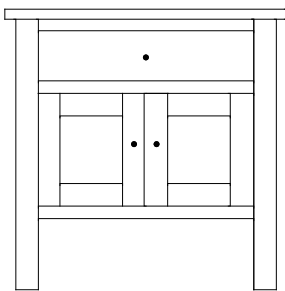

CA-544 Night Stand
28"w 28"h 17½"d
w/1 drawer, 2 doors

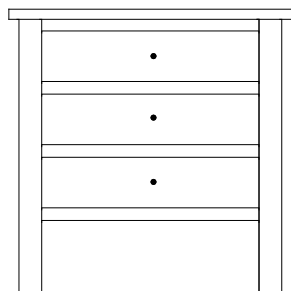

CA-545 Night Stand
28"w 28"h 17½"d
w/3 drawers

Cabin Creek Lingeries & Chests



CA-551
Hi-Boy shown

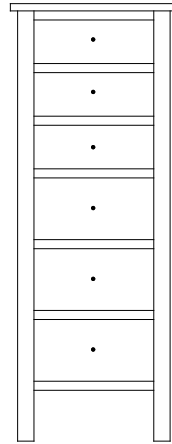

CA-546 Lingerie
23"w 60¼"h 21½"d
w/6 drawers

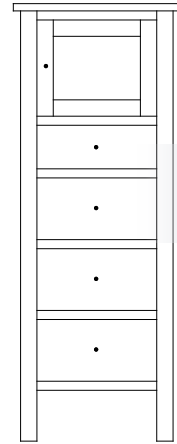

Available with
mirror panel
in door (CA-548)

CA-547 Lingerie
23"w 60¼"h 21½"d
w/4 drawers, 1 wood door,
1 adjustable shelf

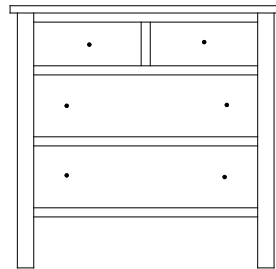

CA-549 Chest
37¼"w 36"h 21½"d
w/4 drawers

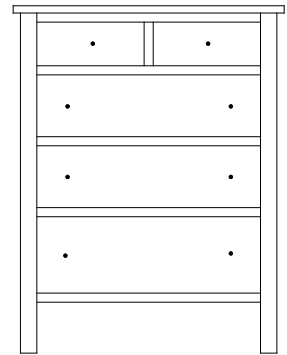

CA-550 Chest
37¼"w 47¾"h 21½"d
w/5 drawers

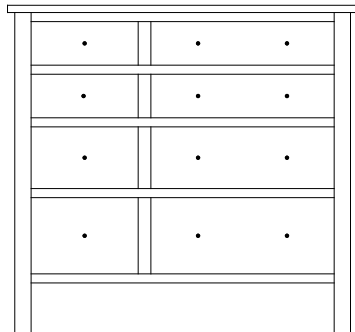

CA-557 Chest
48¼"w 45¼"h 21½"d
w/8 drawers

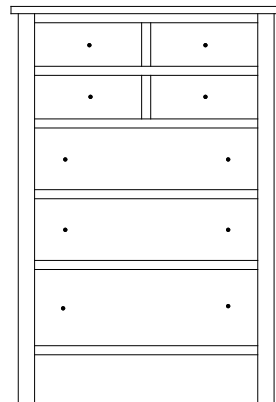

CA-551 Hi-Boy
37¼"w 55"h 21½"d
w/7 drawers

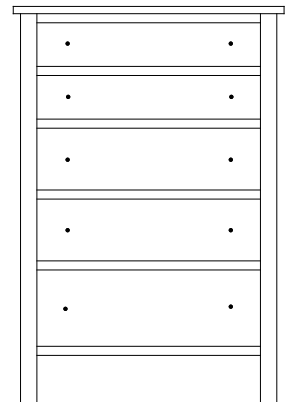

CA-561 Hi-Boy
37¼"w 55"h 21½"d
w/5 drawers

Cabin Creek Miscellaneous

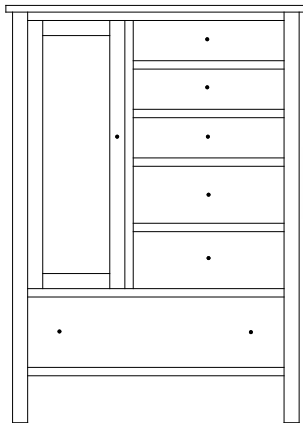

Option:
Mirror on
back of door

CA-552 Chifferobe
44³/₄"w 62¹/₄"h 21¹/₂"d
w/6 drawers, 1 door, 2 adjustable shelves

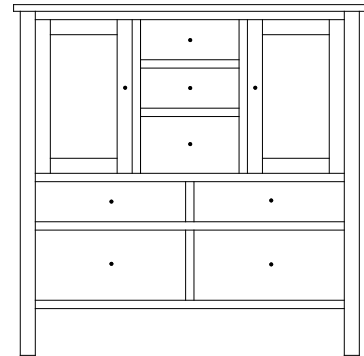

CA-553 His & Hers
52³/₄"w 52¹/₂"h 21¹/₂"d
w/7 drawers, 2 doors, 2 adjustable shelves

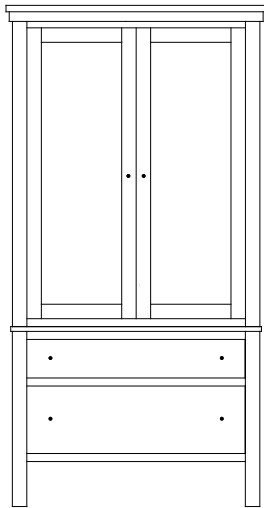

CA-562 Armoire
40¹/₂"w 78"h 21¹/₂"d
w/2 drawers, 2 doors,
2 adjustable shelves, closet rod

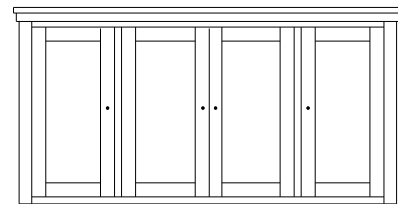

CA-559 Mule Chest Top
69¹/₄"w 35"h 21¹/₂"d
w/4 doors, 6 adjustable shelves

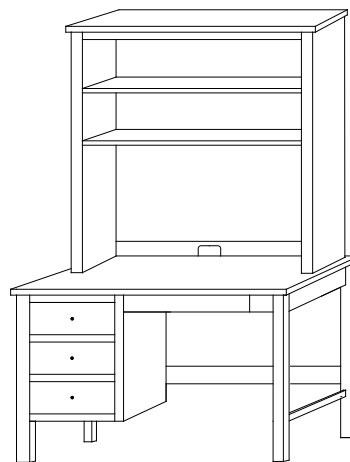

CA-497 Study Carrel
48"w 42"h 13"d
w/2 adjustable shelves

CA-499 Student Desk
48"w 29¹/₂"h 22¹/₂"d
w/3 drawers, 1 pencil drawer

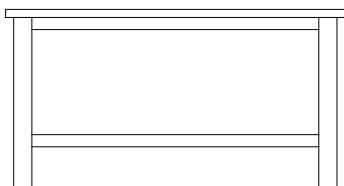

CA-498 Blanket Chest
42"w 22"h 21¹/₂"d

Available
with aromatic
cedar bottom

Upgrades available on student desk:

Keyboard slideout instead of pencil drawer
File drawer instead of bottom 2 drawers

Cabin Creek Dressers



CA-558 Dresser shown with MI-1733 Mirror

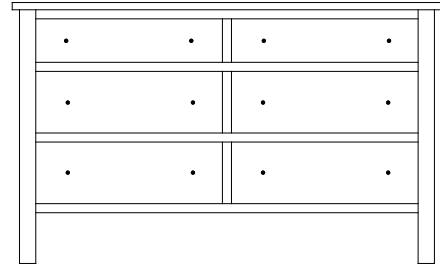

CA-554 Dresser
59¼"w 36"h 21½"d
w/6 drawers

Suggested Mirrors:

MI-1730 Mirror
40"h 36"w

MI-1830 Mirror
40"h 36"w

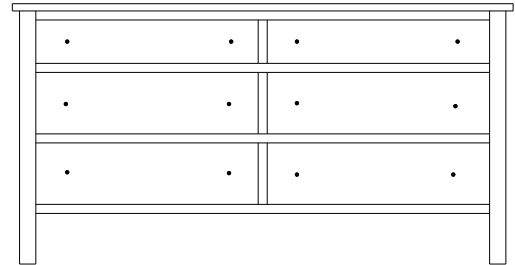

CA-555 Dresser
69¼"w 36"h 21½"d
w/6 drawers

Suggested Mirrors:

MI-1731 Mirror
40"h 46"w

MI-1831 Mirror
40"h 46"w

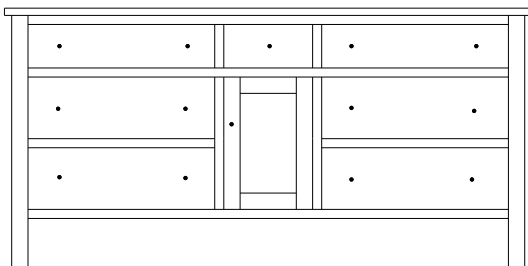

CA-556 Dresser
72¾"w 36"h 21½"d
w/7 drawers, 1 door,
1 adjustable shelf

Suggested Mirrors:

MI-1731 Mirror
40"h 46"w

MI-1831 Mirror
40"h 46"w

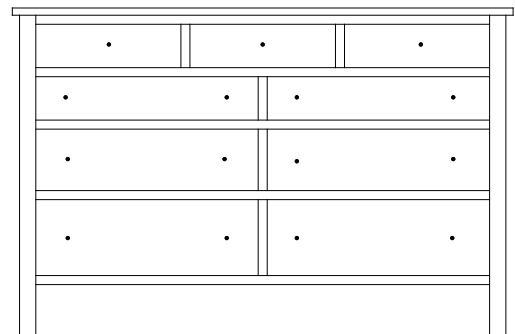

CA-558 Dresser
69¼"w 45¼"h 21½"d
w/9 drawers

Suggested Mirrors:

MI-1733 Mirror
32"h 52"w

MI-1833 Mirror
32"h 52"w

Cabin Creek Mirrors



Beveled Mirror

MI-1730 Mirror
40"high 36"wide

MI-1731 Mirror
40"high 46"wide

MI-1732 Mirror
32"high 42"wide

MI-1733 Mirror
32"high 52"wide



Beveled Mirror

MI-1830 Mirror
40"high 36"wide

MI-1831 Mirror
40"high 46"wide

MI-1832 Mirror
32"high 42"wide

MI-1833 Mirror
32"high 52"wide

Cabin Creek Bed Frames



shown with Regular Footboard



shown with Regular Footboard

Prairie Bed Regular Footboard

Available
with underbed
storage options.

PI-1122-K (King)
81 $\frac{5}{8}$ "w 84 $\frac{1}{2}$ "l
HB 53"h ■ FB 30"h

PI-1122-Q (Queen)
66"w 84 $\frac{1}{2}$ "l
HB 53"h ■ FB 30"h

PI-1122-F (Full)
58 $\frac{7}{8}$ "w 79 $\frac{1}{2}$ "l
HB 53"h ■ FB 30"h

PI-1122-T (Twin)
44"w 79 $\frac{1}{2}$ "l
HB 53"h ■ FB 30"h

Low Footboard

PI-1124-K (King)
81 $\frac{5}{8}$ "w 84 $\frac{1}{2}$ "l
HB 53"h ■ FB 14 $\frac{3}{4}$ "h

PI-1124-Q (Queen)
66"w 84 $\frac{1}{2}$ "l
HB 53"h ■ FB 14 $\frac{3}{4}$ "h

PI-1124-F (Full)
58 $\frac{7}{8}$ "w 79 $\frac{1}{2}$ "l
HB 53"h ■ FB 14 $\frac{3}{4}$ "h

PI-1124-T (Twin)
44"w 79 $\frac{1}{2}$ "l
HB 53"h ■ FB 14 $\frac{3}{4}$ "h

Headboard Only

PI-1126K-HB (King)
53" high

PI-1126Q-HB (Queen)
53" high

PI-1126F-HB (Full)
53" high

PI-1126T-HB (Twin)
53" high

Cabin Creek Bed Regular Footboard

Available
with underbed
storage options.

CA-564-K (King)
82 $\frac{3}{8}$ "w 89 $\frac{1}{2}$ "l
HB 49 $\frac{1}{4}$ "h ■ FB 21 $\frac{1}{4}$ "h

CA-564-Q (Queen)
66 $\frac{5}{8}$ "w 89 $\frac{1}{2}$ "l
HB 49 $\frac{1}{4}$ "h ■ FB 21 $\frac{1}{4}$ "h

CA-564-F (Full)
59 $\frac{3}{8}$ "w 84 $\frac{1}{2}$ "l
HB 49 $\frac{1}{4}$ "h ■ FB 21 $\frac{1}{4}$ "h

CA-564-T (Twin)
44 $\frac{1}{2}$ "w 84 $\frac{1}{2}$ "l
HB 49 $\frac{1}{4}$ "h ■ FB 21 $\frac{1}{4}$ "h

Headboard Only

CA-568K-HB (King)
49 $\frac{1}{4}$ " high

CA-568Q-HB (Queen)
49 $\frac{1}{4}$ " high

CA-568F-HB (Full)
49 $\frac{1}{4}$ " high

CA-568T-HB (Twin)
49 $\frac{1}{4}$ " high

Cabin Creek Storage Rail Upgrades

12³/₄" From Floor to Box Spring

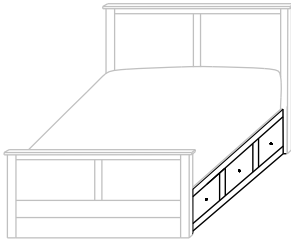

- With 3 drawers on each side
- 12³/₄" from floor to Box Spring
- Inside drawer dimensions on all sizes
9¹/₄"h 18⁷/₈"w 22¹/₂"d

532-SR-K King – 6 drawers
532-SR-Q Queen – 6 drawers
532-SR-F Full – 6 drawers
532-SR-T Twin – 3 drawers

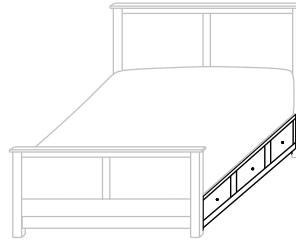

- With 3" Toe Kick
- With 3 drawers on each side
- 12³/₄" from floor to Box Spring
- Inside drawer dimensions on all sizes
6¹/₄"h 18⁷/₈"w 22¹/₂"d

234-SR-K King – 6 drawers
234-SR-Q Queen – 6 drawers
234-SR-F Full – 6 drawers
234-SR-T Twin – 3 drawers

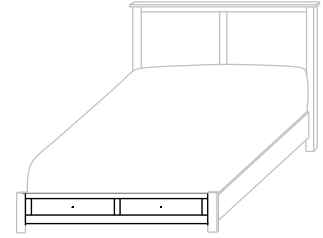

- 12³/₄" from floor to Box Spring
- Inside drawer dimensions
6¹/₄"h 22¹/₂"d
(King) 31" w (Queen) 23¹/₄" w
(Full) 19⁵/₈" w (Twin) 29¹/₄" w

685-FDS-K King – 2 drawers
685-FDS-Q Queen – 2 drawers
685-FDS-F Full – 2 drawers
685-FDS-T Twin – 1 drawer

19³/₄" From Floor to Box Spring

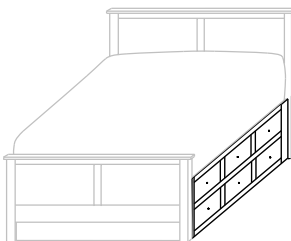

- With 6 drawers on each side
- Twin has 6 drawers on 1 side only
- 19³/₄" from floor to Box Spring
- Inside drawer dimensions on all sizes
6¹/₄"h 18⁷/₈"w 22¹/₂"d

654-SR-K King – 12 drawers
654-SR-Q Queen – 12 drawers
654-SR-F Full – 12 drawers
654-SR-T Twin – 6 drawers

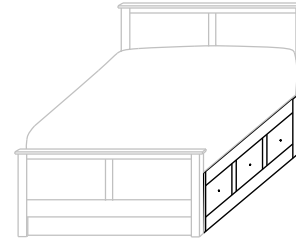

- With 3 drawers on each side
- 19³/₄" from floor to Box Spring
- Inside drawer dimensions on all sizes
10¹/₄"h 18⁷/₈"w 22¹/₂"d

325-SR-K King – 6 drawers
325-SR-Q Queen – 6 drawers
325-SR-F Full – 6 drawers
325-SR-T Twin – 3 drawers

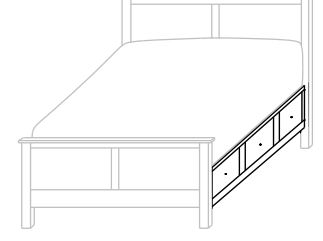

- With 7" Toe Kick
- With 3 drawers on each side
- 19³/₄" from floor to Box Spring
- Inside drawer dimensions on all sizes
9¹/₄"h 18⁷/₈"w 22¹/₂"d

236-SR-K King – 6 drawers
236-SR-Q Queen – 6 drawers
236-SR-F Full – 6 drawers
236-SR-T Twin – 3 drawers

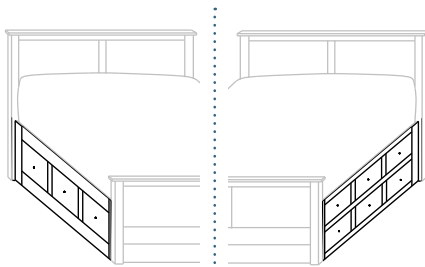

- With 3 drawers on one side and 6 drawers on other side
- 19³/₄" from floor to Box Spring

420-SR-K King – 9 drawers
420-SR-Q Queen – 9 drawers
420-SR-F Full – 9 drawers
 (Twin Not Available)

Additional Upgrades

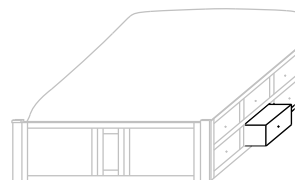

- With Step Stool Pullout in place of drawer

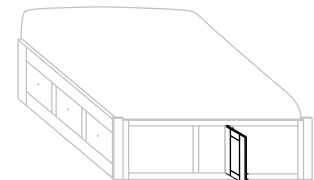

- With Door in Footboard to access area between rails





Canyon Creek
Bedroom Collection

Canyon Creek



Canyon Creek Bedroom Collection

- CC-2565Q Queen Bed
- CC-2542 Night Stand
- CC-2550 Chest
- CC-2557 Dresser
- MI-2532 Mirror

Shown above in **Rustic QWO** with **OCS-113 Michael's** and **Optional Leather Accents** with **4425-WI Knobs** and **4424-WI Pulls**

Standard Features:



4425-WI Knobs
& 4424-WI Pulls



Standard with side-mount drawer slides

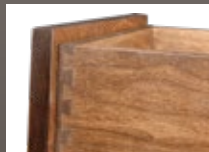

Stained poplar dovetailed drawers



Dovetailed bed slats

Available Upgrades:

- Any hardware on our Hardware Options Sheet
- Leather Accent Panels in top drawers & bed [See Price List]
- Undermount soft close slides [See Price List]



- CC-2565Q Queen Bed
- CC-2545 Night Stand
- CC-2550 Chest
- CC-2558 Dresser
- MI-2533 Mirror

Shown in **Rustic QWO** with **OCS-122 Cocoa** and **Optional L555 Antique White Leather Accents** with **4425-WI Knobs** and **4424-WI Pulls**

Canyon Creek Night Stands



CC-2545
Night Stand shown

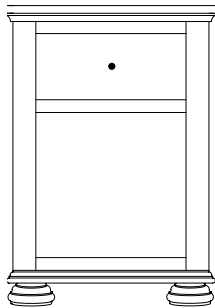

CC-2540 Night Stand
21¾"w 29½"h 17¾"d
w/1 drawer

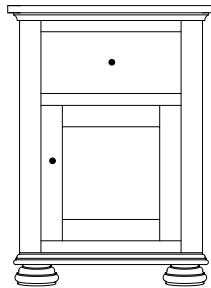

CC-2541 Night Stand
21¾"w 29½"h 17¾"d
w/1 drawer, 1 door

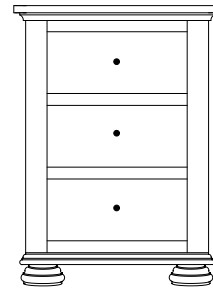

CC-2542 Night Stand
21¾"w 29½"h 17¾"d
w/3 drawers

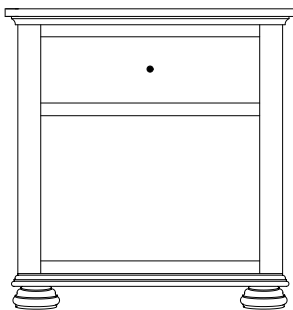

CC-2543 Night Stand
28½"w 29½"h 17¾"d
w/1 drawer

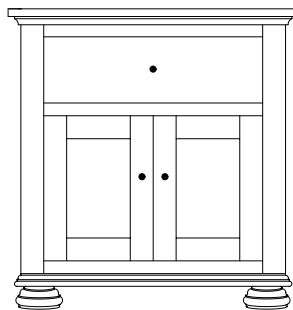

CC-2544 Night Stand
28½"w 29½"h 17¾"d
w/1 drawer, 2 doors



CC-2545 Night Stand
28½"w 29½"h 17¾"d
w/3 drawers

Canyon Creek Lingeries & Chests



CC-2550
Chest shown

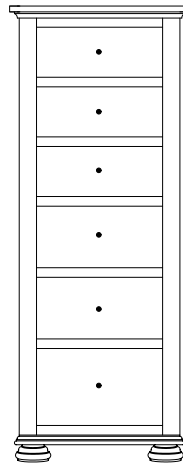

CC-2546 Lingerie
23 $\frac{3}{8}$ "w 59 $\frac{1}{4}$ "h 21 $\frac{3}{4}$ "d
w/7 drawers

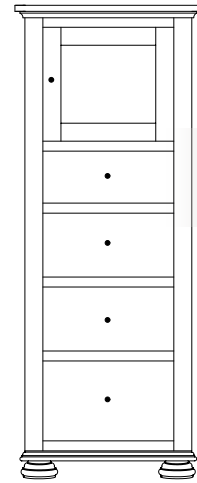

Available with
mirror in
door panel

CC-2547 Lingerie
23 $\frac{3}{8}$ "w 59 $\frac{1}{4}$ "h 21 $\frac{3}{4}$ "d
w/4 drawers, 1 wood door,
1 adjustable shelf



CC-2549 4-Drawer Chest
37 $\frac{3}{4}$ "w 36 $\frac{1}{2}$ "h 21 $\frac{3}{4}$ "d
w/4 drawers

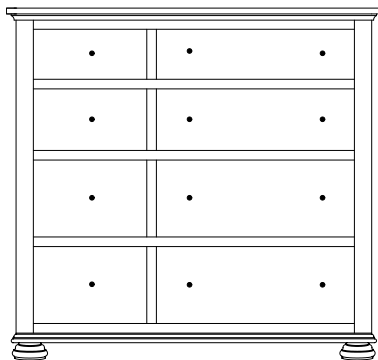

CC-2548 8-Drawer Chest
48 $\frac{3}{4}$ "w 45 $\frac{3}{4}$ "h 21 $\frac{3}{4}$ "d
w/8 drawers

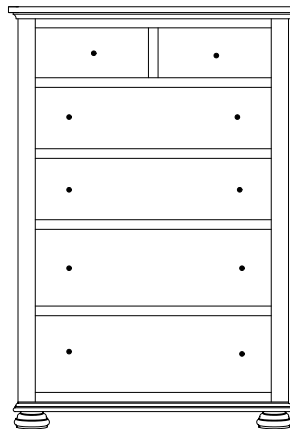

CC-2550 Chest
37 $\frac{3}{4}$ "w 55" h 21 $\frac{3}{4}$ "d
w/6 drawers

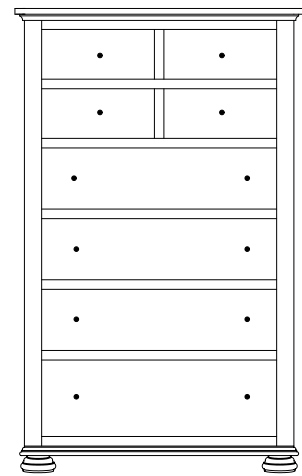

CC-2551 Hi-Boy
37 $\frac{3}{4}$ "w 60 $\frac{3}{4}$ "h 21 $\frac{3}{4}$ "d
w/8 drawers

Canyon Creek Miscellaneous

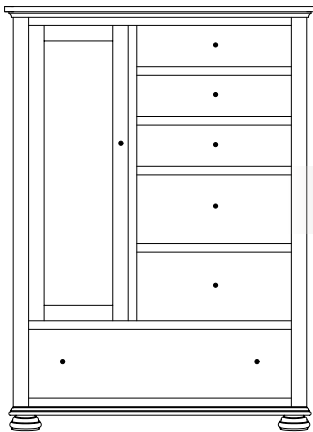

Option:
Mirror on
back of door

CC-2552 Chifferobe
45¼"w 61¾"h 21¾"d
w/6 drawers, 1 door, 2 adj. shelves

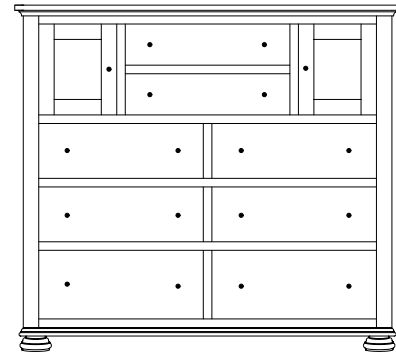

CC-2553 His & Hers Chest
56¼"w 50½"h 21¾"d
w/8 drawers, 2 doors

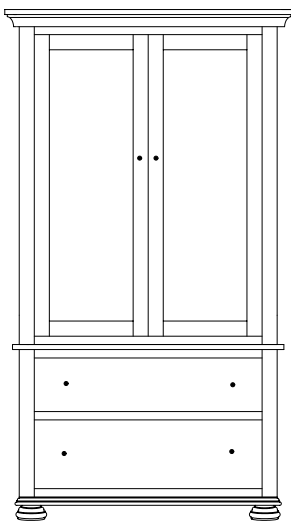

CC-2562 Armoire
42"w 76¼"h 22¼"d
w/2 drawers, w/2 doors,
2 adj. shelves & closet rod

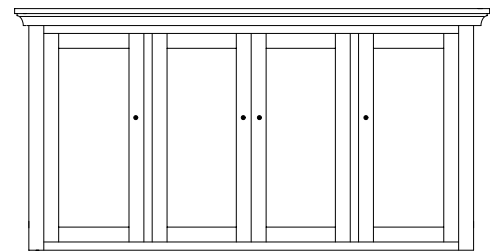

CC-2559 Mule Chest Top
70¾"w 36½"h 21¾"d
w/4 doors & 6 adjustable shelves

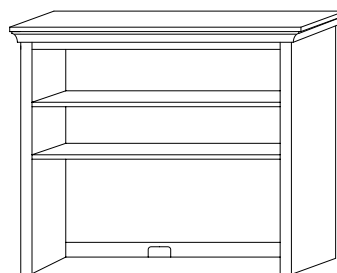

CC-2597 Study Carrel
49½"w 42"h 13¾"d
w/2 adjustable shelves

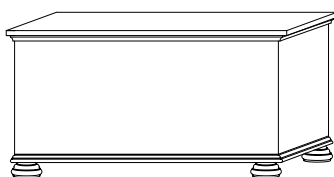

CC-2535 Blanket Chest
42"w 22"h 21½"d

- Available
with aromatic
cedar bottom
- Fabric or
Leather Seat

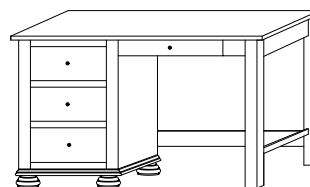

CC-2599 Student Desk
48"w 28¾"h 23"d
w/3 drawers
w/1 pencil drawer

Upgrades available on student desk:

Keyboard slideout instead of pencil drawer
File drawer instead of bottom 2 drawers

Canyon Creek Dressers



CC-2558 Dresser shown with MI-2532 Mirror

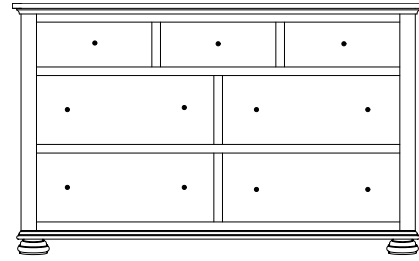

CC-2554 Dresser
59¾"w 36½"h 21¾"d
w/7 drawers

Suggested Mirrors:

MI-2530 Mirror
45"h 36"w

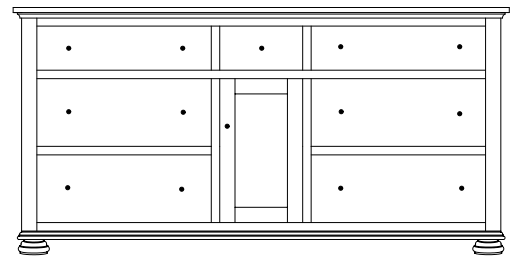

CC-2556 Dresser
73¼"w 36½"h 21¾"d
w/7 drawers, 1 door
w/1 adjustable shelf

Suggested Mirrors:

MI-2531 Mirror
45"h 46"w

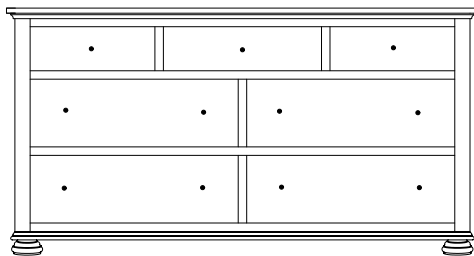

CC-2555 Dresser
69¾"w 36½"h 21¾"d
w/7 drawers

Suggested Mirrors:

MI-2531 Mirror
45"h 46"w

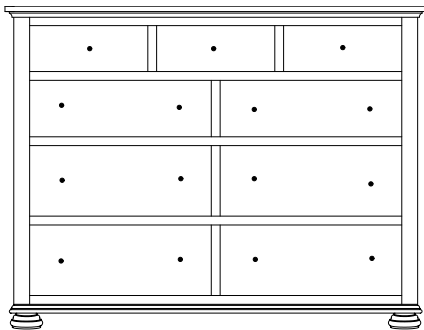

CC-2557 Dresser
59¾"w 45¾"h 21¾"d
w/9 drawers

Suggested Mirrors:

MI-2532 Mirror
37"h 42"w

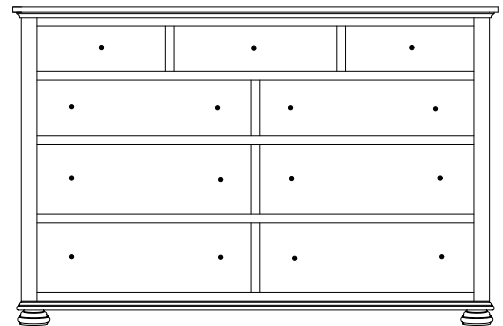

CC-2558 Dresser
69¾"w 45¾"h 21¾"d
w/9 drawers

Suggested Mirrors:

MI-2533 Mirror
37"h 52"w

Canyon Creek Mirrors



MI-2530 Mirror
45"h 36"w

MI-2531 Mirror
45"h 46"w

MI-2532 Mirror
37"h 42"w

MI-2533 Mirror
37"h 52"w

Beveled Mirror

Canyon Creek Bed Frames



Bed shown with **Regular Footboard** and **Optional Leather Panels**

Canyon Creek Bed

Regular Footboard

Available with underbed storage options.

CC-2565-K (King)
82 $\frac{5}{8}$ "w 88"l
HB 58"h ■ FB 27"h

CC-2565-Q (Queen)
67"w 88"l
HB 58"h ■ FB 27"h

CC-2565-F (Full)
59 $\frac{7}{8}$ "w 83"l
HB 58"h ■ FB 27"h

CC-2565-T (Twin)
45"w 83"l
HB 58"h ■ FB 27"h

Low Footboard

CC-2566-K (King)
82 $\frac{5}{8}$ "w 86 $\frac{1}{4}$ "l
HB 45"high ■ FB 14 $\frac{3}{4}$ "h

CC-2566-Q (Queen)
67"w 86 $\frac{1}{4}$ "l
HB 58"high ■ FB 14 $\frac{3}{4}$ "h

CC-2566-F (Full)
59 $\frac{7}{8}$ "w 81 $\frac{1}{4}$ "l
HB 58"high ■ FB 14 $\frac{3}{4}$ "h

CC-2566-T (Twin)
45"w 81 $\frac{1}{4}$ "l
HB 58"high ■ FB 14 $\frac{3}{4}$ "h

Headboard Only

CC-2567K-HB (King)
58" high

CC-2567Q-HB (Queen)
58" high

CC-2567F-HB (Full)
58" high

CC-2567T-HB (Twin)
58" high

Canyon Creek Storage Rail Upgrades

12³/₄" From Floor to Box Spring

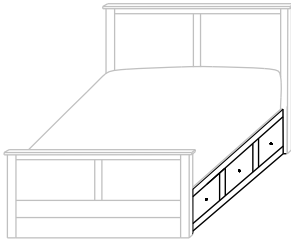

- With 3 drawers on each side
- 12³/₄" from floor to Box Spring
- Inside drawer dimensions on all sizes
9¹/₄"h 18⁷/₈"w 22¹/₂"d

532-SR-K King – 6 drawers
532-SR-Q Queen – 6 drawers
532-SR-F Full – 6 drawers
532-SR-T Twin – 3 drawers

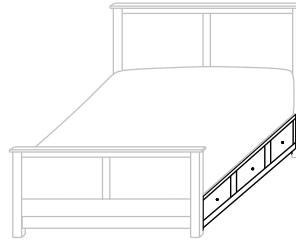

- With 3" Toe Kick
- With 3 drawers on each side
- 12³/₄" from floor to Box Spring
- Inside drawer dimensions on all sizes
6¹/₄"h 18⁷/₈"w 22¹/₂"d

234-SR-K King – 6 drawers
234-SR-Q Queen – 6 drawers
234-SR-F Full – 6 drawers
234-SR-T Twin – 3 drawers

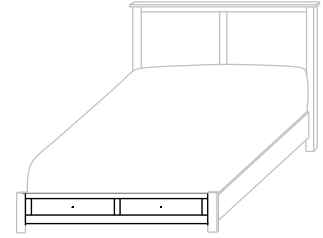

- 12³/₄" from floor to Box Spring
- Inside drawer dimensions
6¹/₄"h 22¹/₂"d
 (King) 31" w (Queen) 23¹/₄" w
 (Full) 19⁵/₈" w (Twin) 29¹/₄" w

685-FDS-K King – 2 drawers
685-FDS-Q Queen – 2 drawers
685-FDS-F Full – 2 drawers
685-FDS-T Twin – 1 drawer

19³/₄" From Floor to Box Spring

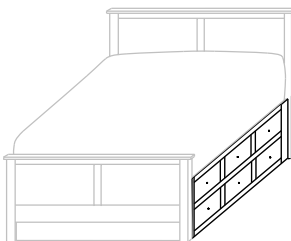

- With 6 drawers on each side
- Twin has 6 drawers on 1 side only
- 19³/₄" from floor to Box Spring
- Inside drawer dimensions on all sizes
6¹/₄"h 18⁷/₈"w 22¹/₂"d

654-SR-K King – 12 drawers
654-SR-Q Queen – 12 drawers
654-SR-F Full – 12 drawers
654-SR-T Twin – 6 drawers

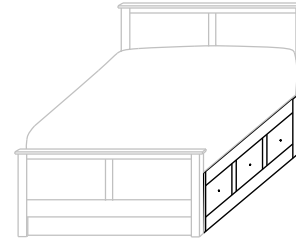

- With 3 drawers on each side
- 19³/₄" from floor to Box Spring
- Inside drawer dimensions on all sizes
10¹/₄"h 18⁷/₈"w 22¹/₂"d

325-SR-K King – 6 drawers
325-SR-Q Queen – 6 drawers
325-SR-F Full – 6 drawers
325-SR-T Twin – 3 drawers

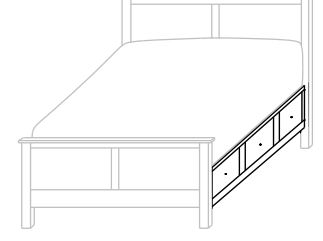

- With 7" Toe Kick
- With 3 drawers on each side
- 19³/₄" from floor to Box Spring
- Inside drawer dimensions on all sizes
9¹/₄"h 18⁷/₈"w 22¹/₂"d

236-SR-K King – 6 drawers
236-SR-Q Queen – 6 drawers
236-SR-F Full – 6 drawers
236-SR-T Twin – 3 drawers

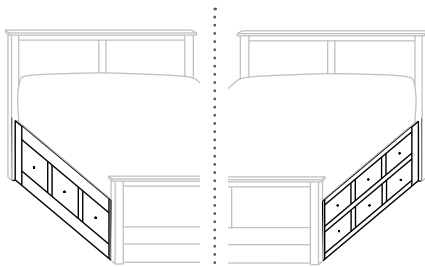

- With 3 drawers on one side and 6 drawers on other side
- 19³/₄" from floor to Box Spring

420-SR-K King – 9 drawers
420-SR-Q Queen – 9 drawers
420-SR-F Full – 9 drawers
 (Twin Not Available)

Additional Upgrades

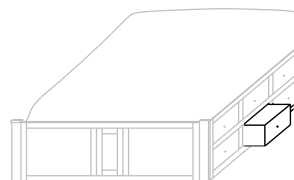

- With Step Stool Pullout in place of drawer

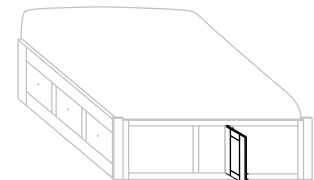

- With Door in Footboard to access area between rails





Chelsea

Bedroom Collection

Chelsea



Chelsea Bedroom Collection w/Rainbow Panel Bed

- CA-443Q Queen Bed
- CS-1639 Night Stand
- CS-1650 Chest
- CS-1654 Dresser
- MI-1730 Mirror

Shown above in **Brown Maple** with **OCS-111 Boston** and **53005-ORB Hardware**

Standard Features:



53005-ORB Knobs



Standard with side-mount drawer slides

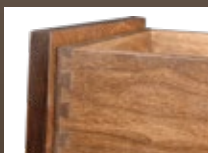

Stained poplar drawer boxes



Dovetailed bed slats



- RW-1910Q Rosewood Poster Bed
- CS-1645 Night Stand
- CS-1651 Hi-Boy
- CS-1657 Dresser
- MI-1632 Mirror
- CS-1635 Blanket Chest

Shown in *Rustic Cherry* with **OCS-104 Seely** and **53005-ORB Hardware**

Available Upgrades:

- Any hardware on our Hardware Options Sheet
- Undermount soft close slides [See Price List]

Chelsea Night Stands



CS-1645
Night Stand shown



Sliding top option available on all night stands
(Hidden compartment w/Lock)

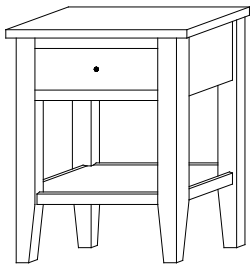

CS-1639 Night Stand
21¼"w 28"h 18½"d
w/1 drawer

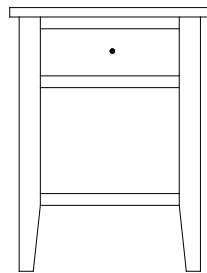

CS-1640 Night Stand
21¼"w 28"h 17½"d
w/1 drawer

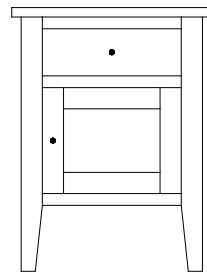

CS-1641 Night Stand
21¼"w 28"h 17½"d
w/1 drawer, 1 door

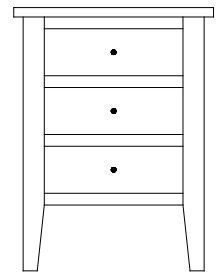

CS-1642 Night Stand
21¼"w 28"h 17½"d
w/3 drawers

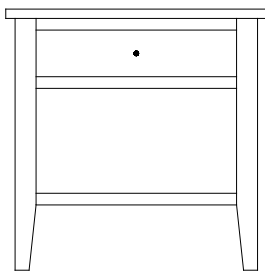

CS-1643 Night Stand
28"w 28"h 17½"d
w/1 drawer

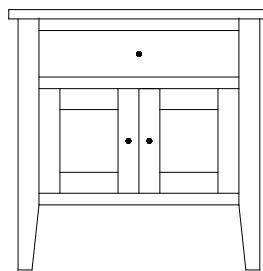

CS-1644 Night Stand
28"w 28"h 17½"d
w/1 drawer, 2 doors

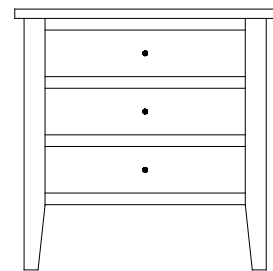

CS-1645 Night Stand
28"w 28"h 17½"d
w/3 drawers

Chelsea Lingeries & Chests



CS-1651
Hi-Boy shown

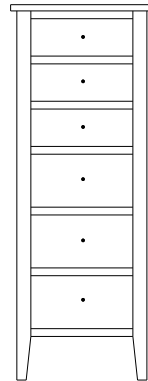

CS-1646 Lingerie
23"w 60¼"h 21½"d
w/6 drawers

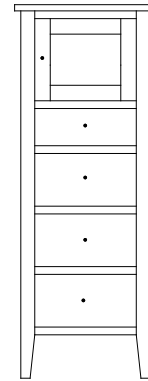

Available with
mirror panel
in door

CS-1647 Lingerie
23"w 60¼"h 21½"d
w/4 drawers, 1 wood door,
1 adjustable shelf



CS-1649 Chest
37¼"w 36"h 21½"d
w/4 drawers

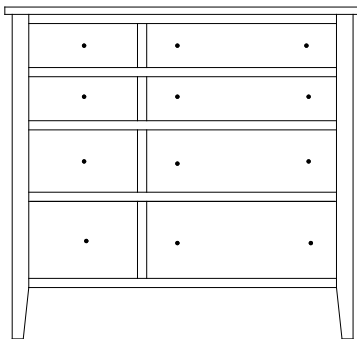

CS-1648 Chest
48¼"w 45¼"h 21½"d
w/8 drawers

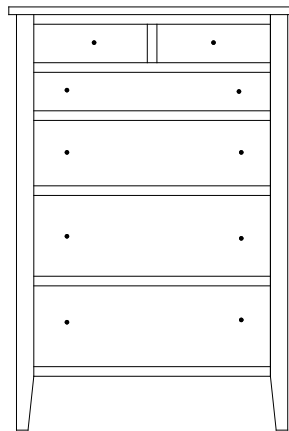

CS-1650 Chest
37¼"w 54"h 21½"d
w/6 drawers

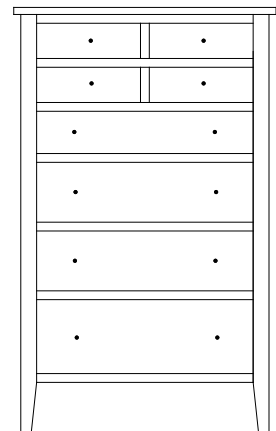

CS-1651 Hi-Boy
37¼"w 60¼"h 21½"d
w/8 drawers

Chelsea Miscellaneous

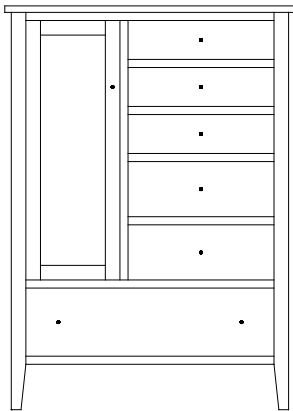

Option:
Mirror on
back of door

CS-1652 Chifferobe
44¾"w 62¼"h 21½"d
w/6 drawers, 1 door, 2 adj. shelves

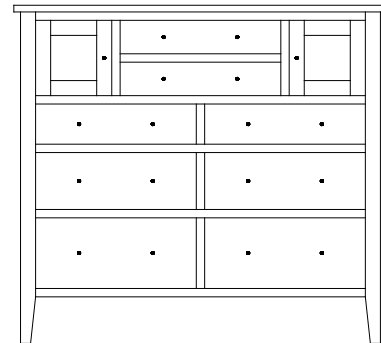

CS-1653 His & Hers
55¾"w 50½"h 21½"d
w/8 drawers, 2 doors

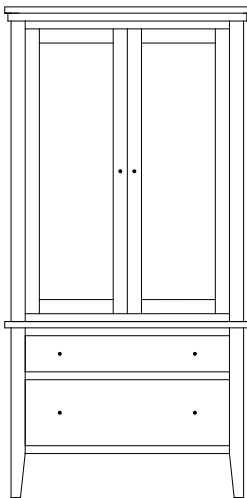

CS-1662 Armoire
40½"w 78"h 21½"d
w/2 drawers, (top drawer w/divider)
w/2 doors, 2 adj. shelves & closet rod

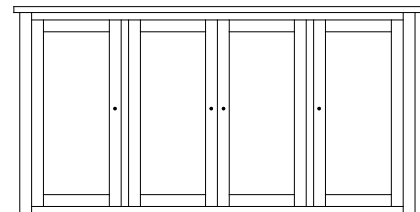

CS-1659 Mule Chest Top
69¼"w 35"h 21½"d
w/4 doors & 6 adjustable shelves

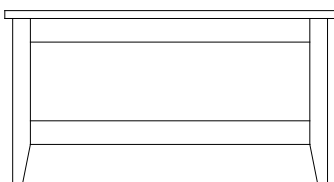

CS-1635 Blanket Chest
42"w 22"h 21½"d

Available
with aromatic
cedar bottom

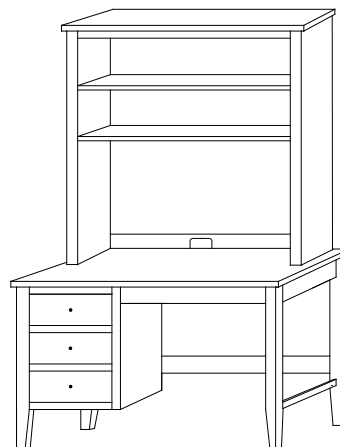

CS-1697 Study Carrel
48"w 42"h 13"d
w/2 adjustable shelves

CS-1699 Student Desk
48"w 29½"h 22½"d
w/3 drawers
w/1 pencil drawer

Upgrades available on student desk:

Keyboard slideout instead of pencil drawer
File drawer instead of bottom 2 drawers

Chelsea Dressers



CS-1657 Dresser shown with MI-1632 Mirror

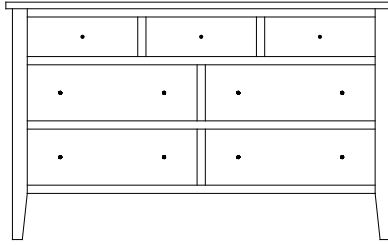

CS-1654 Dresser
59¼"w 36"h 21½"d
w/7 drawers

Suggested Mirrors:

MI-1630 Mirror
40"h 36"w

MI-1730 Mirror
40"h 36"w

MI-1830 Mirror
40"h 36"w

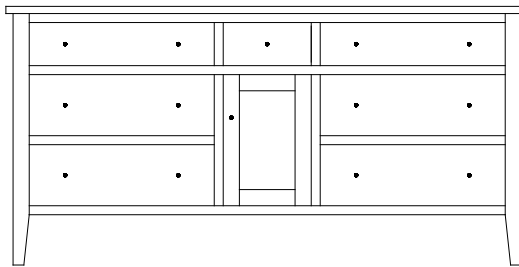

CS-1656 Dresser
72¾"w 36"h 21½"d
w/7 drawers, 1 door
w/1 adjustable shelf

Suggested Mirrors:

MI-1631 Mirror
40"h 46"w

MI-1731 Mirror
40"h 46"w

MI-1831 Mirror
40"h 46"w

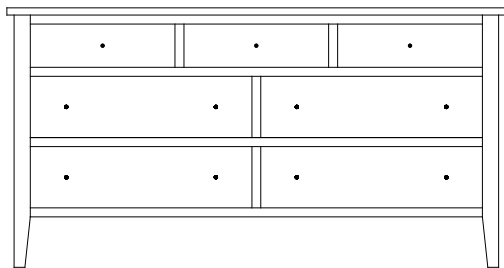

CS-1655 Dresser
69¼"w 36"h 21½"d
w/7 drawers

Suggested Mirrors:

MI-1631 Mirror
40"h 46"w

MI-1731 Mirror
40"h 46"w

MI-1831 Mirror
40"h 46"w

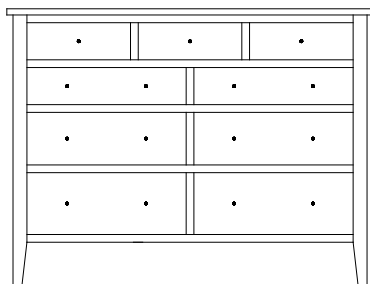

CS-1657 Tall Dresser
59¼"w 45¼"h 21½"d
w/9 drawers

Suggested Mirrors:

MI-1632 Mirror
32"h 42"w

MI-1732 Mirror
32"h 42"w

MI-1832 Mirror
32"h 42"w

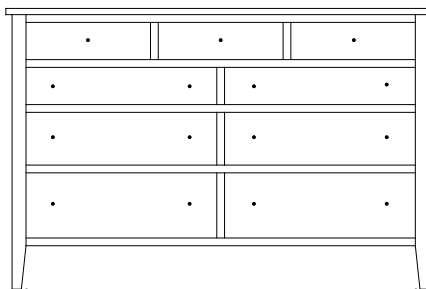

CS-1658 Dresser
69¼"w 45¼"h 21½"d
w/9 drawers

Suggested Mirrors:

MI-1633 Mirror
32"h 52"w

MI-1733 Mirror
32"h 52"w

MI-1833 Mirror
32"h 52"w

Chelsea Mirrors



Beveled Mirror

MI-1630 Mirror
40"high 36"wide

MI-1631 Mirror
40"high 46"wide

MI-1632 Mirror
32"high 42"wide

MI-1633 Mirror
32"high 52"wide



Beveled Mirror

MI-1730 Mirror
40"high 36"wide

MI-1731 Mirror
40"high 46"wide

MI-1732 Mirror
32"high 42"wide

MI-1733 Mirror
32"high 52"wide



Beveled Mirror

MI-1830 Mirror
40"high 36"wide

MI-1831 Mirror
40"high 46"wide

MI-1832 Mirror
32"high 42"wide

MI-1833 Mirror
32"high 52"wide

Chelsea Bed Frames



Post Height 80"
Posts are removable

shown with Regular Footboard



shown with Regular Footboard

Rosewood Poster Beds

Available
with underbed
storage options.

Regular Footboard

RW-1910-K (King)
80 1/8"w 87 1/2"l
HB 52"h ■ FB 23"h

RW-1910-Q (Queen)
64 3/8"w 87 1/2"l
HB 52"h ■ FB 23"h

RW-1910-F (Full)
57 3/8"w 82 1/2"l
HB 52"h ■ FB 23"h

RW-1910-T (Twin)
42 1/2"w 82 1/2"l
HB 52"h ■ FB 23"h

Headboard Only

RW-1920K-HB (King)
52" high

RW-1920Q-HB (Queen)
52" high

RW-1920F-HB (Full)
52" high

RW-1920T-HB (Twin)
52" high

Rainbow Panel Beds

Available
with underbed
storage options.

Regular Footboard

CA-441-K (King)
85 3/4"w 87"l
HB 59 1/4"h ■ FB 30 1/4"h

CA-441-Q (Queen)
70 1/4"w 87"l
HB 57 1/4"h ■ FB 30 1/4"h

CA-441-F (Full)
63"w 82"l
HB 55 3/4"h ■ FB 30 1/4"h

CA-441-T (Twin)
48 1/8"w 82"l
HB 53 3/4"h ■ FB 30 1/4"h

Low Footboard

CA-443-K (King)
85 3/4"w 85 3/4"l
HB 59 1/4"h ■ FB 14 3/4"h

CA-443-Q (Queen)
70 1/4"w 85 3/4"l
HB 57 1/4"h ■ FB 14 3/4"h

CA-443-F (Full)
63"w 80 3/4"l
HB 55 3/4"h ■ FB 14 3/4"h

CA-443-T (Twin)
48 1/8"w 80 3/4"l
HB 53 3/4"h ■ FB 14 3/4"h

Headboard Only

CA-446K-HB (King)
59 1/4" high

CA-446Q-HB (Queen)
57 1/4" high

CA-446F-HB (Full)
55 3/4" high

CA-446T-HB (Twin)
53 3/4" high

Chelsea Storage Rail Upgrades

12³/₄" From Floor to Box Spring

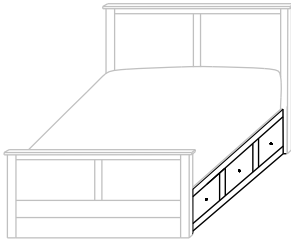

- With 3 drawers on each side
- 12³/₄" from floor to Box Spring
- Inside drawer dimensions on all sizes
9¹/₄"h 18⁷/₈"w 22¹/₂"d

532-SR-K King – 6 drawers
532-SR-Q Queen – 6 drawers
532-SR-F Full – 6 drawers
532-SR-T Twin – 3 drawers

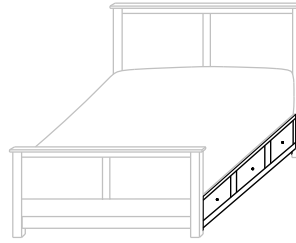

- With 3" Toe Kick
- With 3 drawers on each side
- 12³/₄" from floor to Box Spring
- Inside drawer dimensions on all sizes
6¹/₄"h 18⁷/₈"w 22¹/₂"d

234-SR-K King – 6 drawers
234-SR-Q Queen – 6 drawers
234-SR-F Full – 6 drawers
234-SR-T Twin – 3 drawers

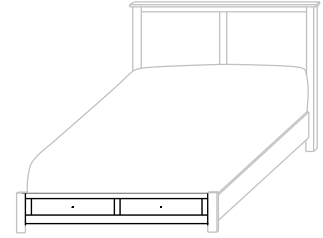

- 12³/₄" from floor to Box Spring
- Inside drawer dimensions
6¹/₄"h 22¹/₂"d
 (King) 31" w (Queen) 23¹/₄" w
 (Full) 19⁵/₈" w (Twin) 29¹/₄" w

685-FDS-K King – 2 drawers
685-FDS-Q Queen – 2 drawers
685-FDS-F Full – 2 drawers
685-FDS-T Twin – 1 drawer

19³/₄" From Floor to Box Spring

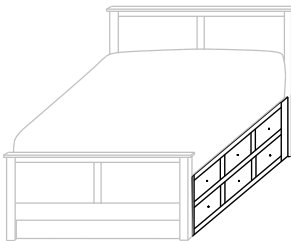

- With 6 drawers on each side
- Twin has 6 drawers on 1 side only
- 19³/₄" from floor to Box Spring
- Inside drawer dimensions on all sizes
6¹/₄"h 18⁷/₈"w 22¹/₂"d

654-SR-K King – 12 drawers
654-SR-Q Queen – 12 drawers
654-SR-F Full – 12 drawers
654-SR-T Twin – 6 drawers

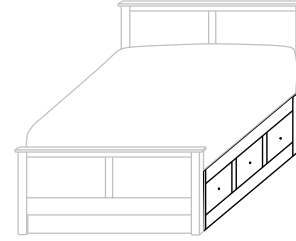

- With 3 drawers on each side
- 19³/₄" from floor to Box Spring
- Inside drawer dimensions on all sizes
10¹/₄"h 18⁷/₈"w 22¹/₂"d

325-SR-K King – 6 drawers
325-SR-Q Queen – 6 drawers
325-SR-F Full – 6 drawers
325-SR-T Twin – 3 drawers

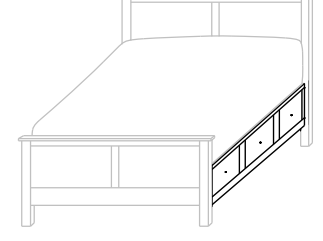

- With 7" Toe Kick
- With 3 drawers on each side
- 19³/₄" from floor to Box Spring
- Inside drawer dimensions on all sizes
9¹/₄"h 18⁷/₈"w 22¹/₂"d

236-SR-K King – 6 drawers
236-SR-Q Queen – 6 drawers
236-SR-F Full – 6 drawers
236-SR-T Twin – 3 drawers

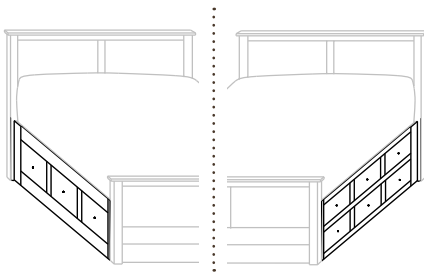

- With 3 drawers on one side and 6 drawers on other side
- 19³/₄" from floor to Box Spring

420-SR-K King – 9 drawers
420-SR-Q Queen – 9 drawers
420-SR-F Full – 9 drawers
 (Twin Not Available)

Additional Upgrades

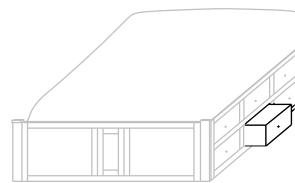

- With Step Stool Pullout in place of drawer

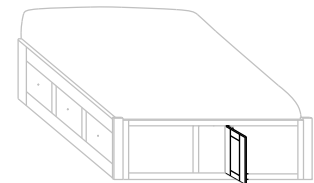

- With Door in Footboard to access area between rails





Claremont Mission
Bedroom Collection

Claremont Mission



Claremont Mission Bedroom Collection w/Claremont Panel Bed

- CM-2003Q Queen Bed
- CM-1540 Night Stand
- CM-1550 Chest
- CM-1554 Dresser
- MI-1965 Mirror

Shown above in **Brown Maple** with **OCS-122 Cocoa**
and **4424-G10 Hardware**

Standard Features:



D925-BL & D924-BL



Standard with side-mount drawer slides

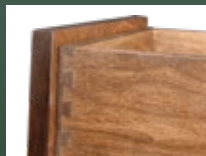

Stained poplar drawer boxes



Dovetailed bed slats

Available Upgrades:

- Any hardware on our Hardware Options Sheet
- Undermount soft close slides [See Price List]



- CM-1983Q Claremont Slat Bed w/234-SR Storage Upgrade
- CM-1545 Night Stand
- CM-1551 Hi-Boy
- CM-1558 Dresser
- MI-1568 Mirror

Shown in **QWO**
with **OCS-113 Michaels** and
D925-BL Hardware

Claremont Mission Night Stands



CM-1545
Night Stand shown



Sliding top option available on all night stands
(Hidden compartment w/Lock)

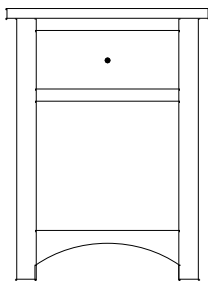

CM-1540 Night Stand
20¾"w 27¾"h 17½"d
w/1 drawer

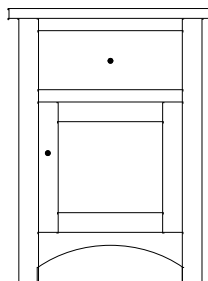

CM-1541 Night Stand
20¾"w 27¾"h 17½"d
w/1 drawer, 1 door

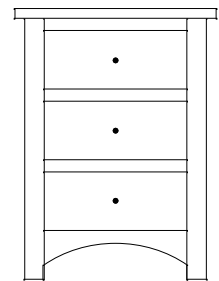

CM-1542 Night Stand
20¾"w 27¾"h 17½"d
w/3 drawers

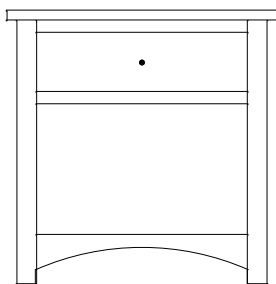

CM-1543 Night Stand
27½"w 27¾"h 17½"d
w/1 drawer

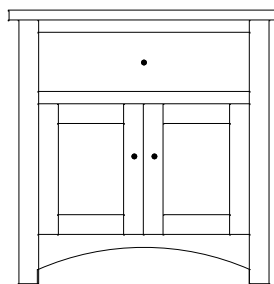

CM-1544 Night Stand
27½"w 27¾"h 17½"d
w/1 drawer, 2 doors

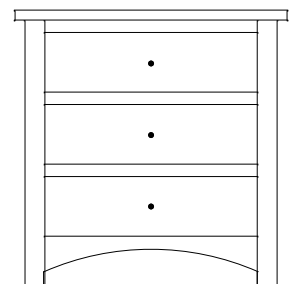

CM-1545 Night Stand
27½"w 27¾"h 17½"d
w/3 drawers

Claremont Mission Lingeries & Chests



CM-1551
Hi-Boy shown

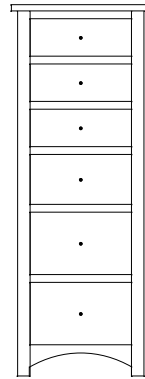

CM-1546 Lingerie
22 $\frac{3}{8}$ "w 59 $\frac{1}{2}$ "h 21 $\frac{1}{2}$ "d
w/6 drawers

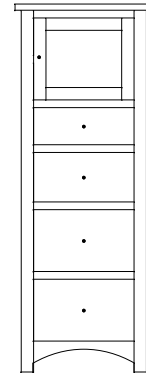

Available with
mirror panel
in door

CM-1547 Lingerie
22 $\frac{3}{8}$ "w 59 $\frac{1}{2}$ "h 21 $\frac{1}{2}$ "d
w/4 drawers, 1 wood door,
1 adjustable shelf

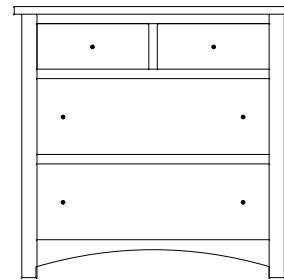

CM-1549 Chest
36 $\frac{3}{4}$ "w 35 $\frac{3}{4}$ "h 21 $\frac{1}{2}$ "d
w/4 drawers

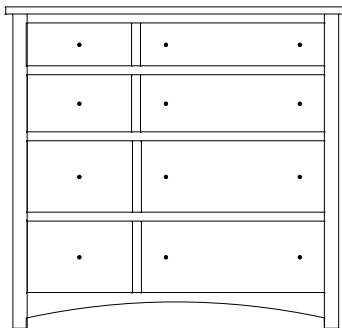

CM-1548 Chest
47 $\frac{3}{4}$ "w 45"h 21 $\frac{1}{2}$ "d
w/8 drawers

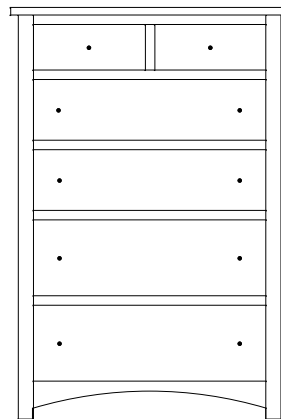

CM-1550 Chest
36 $\frac{3}{4}$ "w 54 $\frac{1}{4}$ "h 21 $\frac{1}{2}$ "d
w/6 drawers

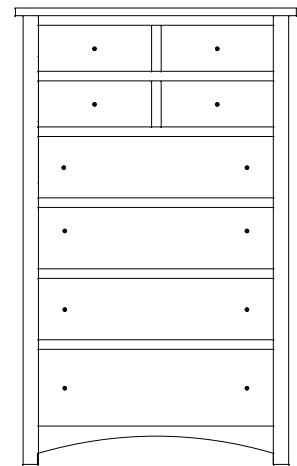

CM-1551 Hi-Boy
36 $\frac{3}{4}$ "w 59 $\frac{1}{2}$ "h 21 $\frac{1}{2}$ "d
w/8 drawers

Claremont Mission Miscellaneous

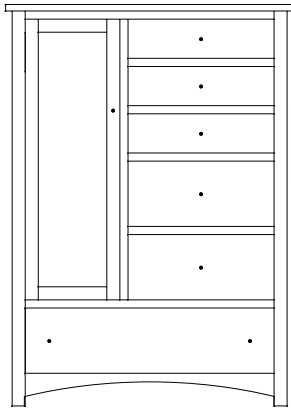

Option:
Mirror on
back of door

CM-1552 Chifferobe
44¼"w 61½"h 21½"d
w/6 drawers, 1 door, 2 adj. shelves

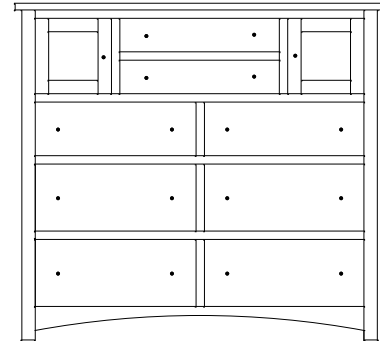

CM-1553 His & Hers
55¼"w 50¼"h 21½"d
w/8 drawers, 2 doors

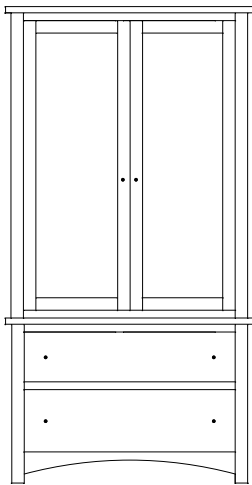

CM-1562 Armoire
40"w 76¼"h 21½"d
w/2 drawers, (top drawer w/divider)
w/2 doors, 2 adj. shelves & closet rod

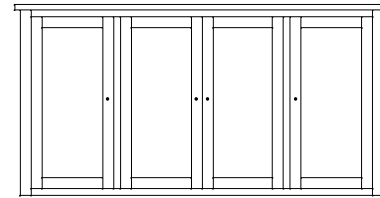

CM-1559 Mule Chest Top
68¾"w 35"h 21½"d
w/4 doors & 6 adjustable shelves

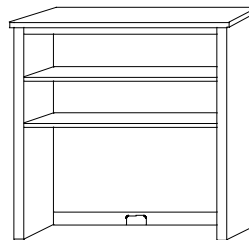

CM-1597 Study Carrel
48"w 42"h 13"d
w/2 adjustable shelves

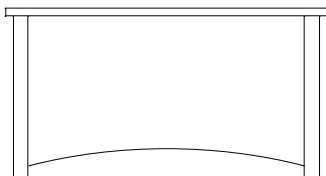

CS-1535 Blanket Chest
42"w 22"h 21½"d

Available
with aromatic
cedar bottom

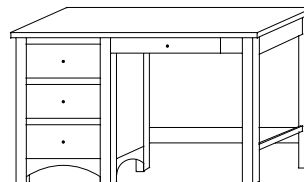

CM-1599 Student Desk
48"w 29¼"h 22½"d
w/3 drawers
w/1 pencil drawer

Upgrades available on student desk:

Keyboard slideout instead of pencil drawer
File drawer instead of bottom 2 drawers

Claremont Mission Dressers



CM-1557 Dresser shown with MI-1567 Mirror

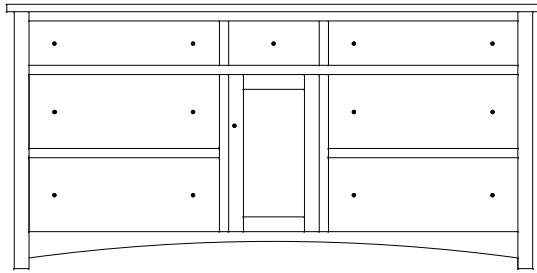

CM-1556 Dresser
72¼"w 35¾"h 21½"d
w/7 drawers, 1 door,
1 adjustable shelf

Suggested Mirrors:

MI-1566 Mirror
45"h 46"w

MI-1731 Mirror
40"h 46"w

MI-1966 Mirror
40"h 46"w

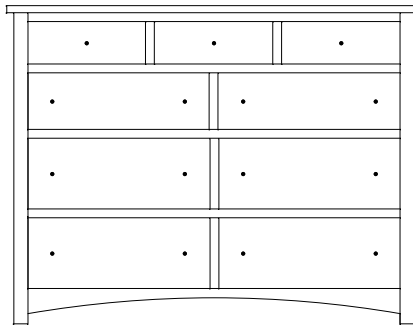

CM-1557 Dresser
58¾"w 45"h 21½"d
w/9 drawers

Suggested Mirrors:

MI-1567 Mirror
37"h 42"w

MI-1732 Mirror
32"h 42"w

MI-1967 Mirror
32"h 42"w

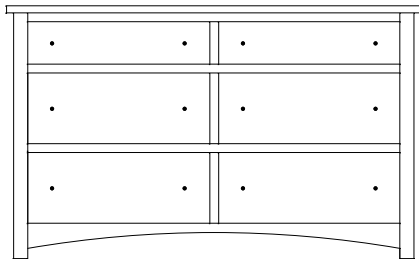

CM-1554 Dresser
58¾"w 35¾"h 21½"d
w/6 drawers

Suggested Mirrors:

MI-1565 Mirror
45"h 36"w

MI-1730 Mirror
40"h 36"w

MI-1965 Mirror
40"h 36"w

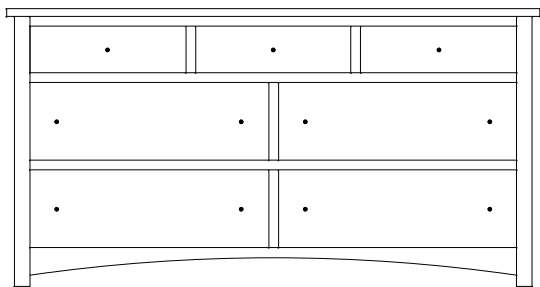

CM-1555 Dresser
68¾"w 35¾"h 21½"d
w/7 drawers

Suggested Mirrors:

MI-1566 Mirror
45"h 46"w

MI-1731 Mirror
40"h 46"w

MI-1966 Mirror
40"h 46"w

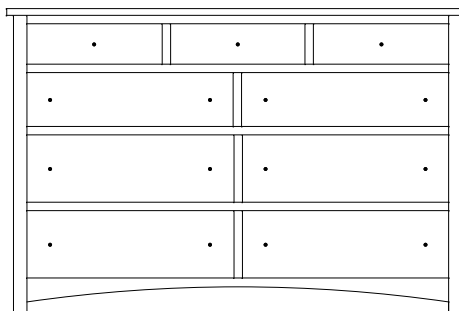

CM-1558 Dresser
68¾"w 45"h 21½"d
w/9 drawers

Suggested Mirrors:

MI-1568 Mirror
37"h 52"w

MI-1733 Mirror
32"h 52"w

MI-1968 Mirror
32"h 52"w

Claremont Mission Mirrors



Beveled Mirror

MI-1565 Mirror
45"high 36"wide

MI-1566 Mirror
45"high 46"wide

MI-1567 Mirror
37"high 42"wide

MI-1568 Mirror
37"high 52"wide



Beveled Mirror

MI-1730 Mirror
40"high 36"wide

MI-1731 Mirror
40"high 46"wide

MI-1732 Mirror
32"high 42"wide

MI-1733 Mirror
32"high 52"wide



Beveled Mirror

MI-1965 Mirror
40"high 36"wide

MI-1966 Mirror
40"high 46"wide

MI-1967 Mirror
32"high 42"wide

MI-1968 Mirror
32"high 52"wide

Claremont Mission Bed Frames



234-SR
Storage
Upgrade

shown with Regular Footboard



shown with Regular Footboard

Claremont Slat Beds

Available
with underbed
storage options.

Regular Footboard

CM-1983-K (King)
81 $\frac{1}{8}$ "w 85 $\frac{3}{4}$ "l
HB 54"h ■ FB 30"h

CM-1983-Q (Queen)
66 $\frac{1}{8}$ "w 85 $\frac{3}{4}$ "l
HB 54"h ■ FB 30"h

CM-1983-F (Full)
58 $\frac{7}{8}$ "w 80 $\frac{3}{4}$ "l
HB 54"h ■ FB 30"h

CM-1983-T (Twin)
44"w 80 $\frac{3}{4}$ "l
HB 54"h ■ FB 30"h

Low Footboard

CM-1990-K (King)
81 $\frac{1}{8}$ "w 85 $\frac{3}{4}$ "l
HB 54"h ■ FB 14 $\frac{3}{4}$ "h

CM-1990-Q (Queen)
66 $\frac{1}{8}$ "w 85 $\frac{3}{4}$ "l
HB 54"h ■ FB 14 $\frac{3}{4}$ "h

CM-1990-F (Full)
58 $\frac{7}{8}$ "w 80 $\frac{3}{4}$ "l
HB 54"h ■ FB 14 $\frac{3}{4}$ "h

CM-1990-T (Twin)
44"w 80 $\frac{3}{4}$ "l
HB 54"h ■ FB 14 $\frac{3}{4}$ "h

Headboard Only

CM-1982K-HB (King)
54" high

CM-1982Q-HB (Queen)
54" high

CM-1982F-HB (Full)
54" high

CM-1982T-HB (Twin)
54" high

Claremont Panel Beds

Available
with underbed
storage options.

Regular Footboard

CM-2002-K (King)
81 $\frac{1}{8}$ "w 85 $\frac{3}{4}$ "l
HB 54"h ■ FB 30"h

CM-2002-Q (Queen)
66 $\frac{1}{8}$ "w 85 $\frac{3}{4}$ "l
HB 54"h ■ FB 30"h

CM-2002-F (Full)
58 $\frac{7}{8}$ "w 80 $\frac{3}{4}$ "l
HB 54"h ■ FB 30"h

CM-2002-T (Twin)
44"w 80 $\frac{3}{4}$ "l
HB 54"h ■ FB 30"h

Low Footboard

CM-2003-K (King)
81 $\frac{1}{8}$ "w 85 $\frac{3}{4}$ "l
HB 54"h ■ FB 14 $\frac{3}{4}$ "h

CM-2003-Q (Queen)
66 $\frac{1}{8}$ "w 85 $\frac{3}{4}$ "l
HB 54"h ■ FB 14 $\frac{3}{4}$ "h

CM-2003-F (Full)
58 $\frac{7}{8}$ "w 80 $\frac{3}{4}$ "l
HB 54"h ■ FB 14 $\frac{3}{4}$ "h

CM-2003-T (Twin)
44"w 80 $\frac{3}{4}$ "l
HB 54"h ■ FB 14 $\frac{3}{4}$ "h

Headboard Only

CM-2001K-HB (King)
54" high

CM-2001Q-HB (Queen)
54" high

CM-2001F-HB (Full)
54" high

CM-2001T-HB (Twin)
54" high

Claremont Mission Storage Rail Upgrades

12³/₄" From Floor to Box Spring

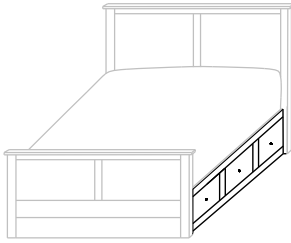

- With 3 drawers on each side
- 12³/₄" from floor to Box Spring
- Inside drawer dimensions on all sizes
9¹/₄"h 18⁷/₈"w 22¹/₂"d

532-SR-K King – 6 drawers
532-SR-Q Queen – 6 drawers
532-SR-F Full – 6 drawers
532-SR-T Twin – 3 drawers

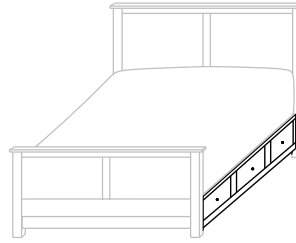

- With 3" Toe Kick
- With 3 drawers on each side
- 12³/₄" from floor to Box Spring
- Inside drawer dimensions on all sizes
6¹/₄"h 18⁷/₈"w 22¹/₂"d

234-SR-K King – 6 drawers
234-SR-Q Queen – 6 drawers
234-SR-F Full – 6 drawers
234-SR-T Twin – 3 drawers

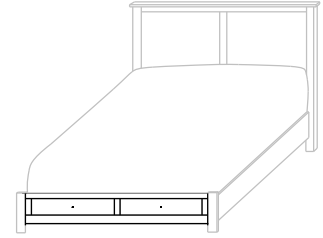

- 12³/₄" from floor to Box Spring
- Inside drawer dimensions
6¹/₄"h 22¹/₂"d
 (King) 31" w (Queen) 23¹/₄" w
 (Full) 19⁵/₈" w (Twin) 29¹/₄" w

685-FDS-K King – 2 drawers
685-FDS-Q Queen – 2 drawers
685-FDS-F Full – 2 drawers
685-FDS-T Twin – 1 drawer

19³/₄" From Floor to Box Spring

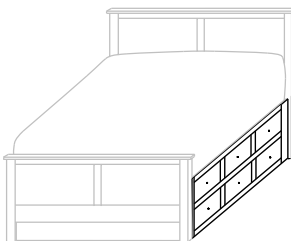

- With 6 drawers on each side
- Twin has 6 drawers on 1 side only
- 19³/₄" from floor to Box Spring
- Inside drawer dimensions on all sizes
6¹/₄"h 18⁷/₈"w 22¹/₂"d

654-SR-K King – 12 drawers
654-SR-Q Queen – 12 drawers
654-SR-F Full – 12 drawers
654-SR-T Twin – 6 drawers

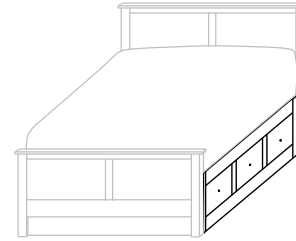

- With 3 drawers on each side
- 19³/₄" from floor to Box Spring
- Inside drawer dimensions on all sizes
10¹/₄"h 18⁷/₈"w 22¹/₂"d

325-SR-K King – 6 drawers
325-SR-Q Queen – 6 drawers
325-SR-F Full – 6 drawers
325-SR-T Twin – 3 drawers

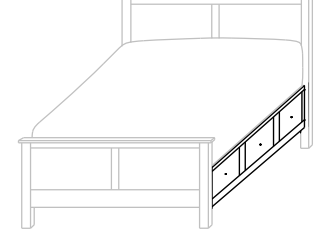

- With 7" Toe Kick
- With 3 drawers on each side
- 19³/₄" from floor to Box Spring
- Inside drawer dimensions on all sizes
9¹/₄"h 18⁷/₈"w 22¹/₂"d

236-SR-K King – 6 drawers
236-SR-Q Queen – 6 drawers
236-SR-F Full – 6 drawers
236-SR-T Twin – 3 drawers

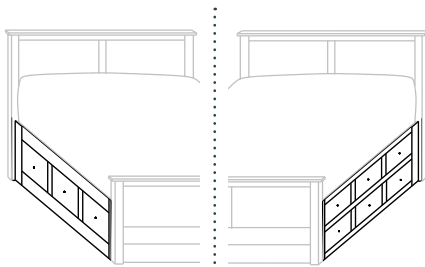

- With 3 drawers on one side and 6 drawers on other side
- 19³/₄" from floor to Box Spring

420-SR-K King – 9 drawers
420-SR-Q Queen – 9 drawers
420-SR-F Full – 9 drawers
 (Twin Not Available)

Additional Upgrades

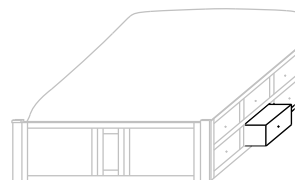

- With Step Stool Pullout in place of drawer

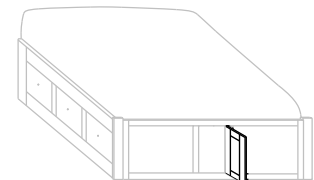

- With Door in Footboard to access area between rails





Hamilton
Bedroom Collection

Hamilton



Hamilton Bedroom Collection w/Hamilton Bed

- HM-1882Q Queen Bed
- HM-1839 Night Stand
- HM-1850 Chest
- HM-1854 Dresser
- MI-1873 Mirror

Shown above in **Brown Maple** with **OCS-117 Asbury** and **K2017-BL Hardware**

Standard Features:



K2017-SN Pulls



Standard with side-mount drawer slides



Stained poplar drawer boxes



Dovetailed bed slats

Available Upgrades:

- Any hardware on our Hardware Options Sheet
- Undermount soft close slides [See Price List]



- HM-1880Q Hamilton Bed w/234-SR Storage Upgrade
- HM-1845 Night Stand
- HM-1850 Chest
- HM-1856 Dresser
- MI-1870 Mirror

Shown in *Cherry* with **FC-15743 Briar** and **K2017-SN Hardware**

Hamilton Night Stands



HM-1845
Night Stand shown



Sliding top option available on all night stands
(Hidden compartment w/Lock)

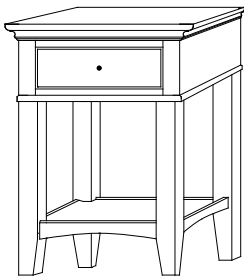

HM-1839 Night Stand
22½"w 30"h 17½"d
w/1 drawer

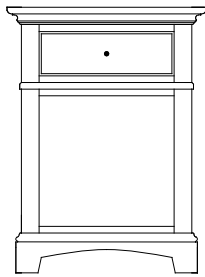

HM-1840 Night Stand
22½"w 30"h 17½"d
w/1 drawer

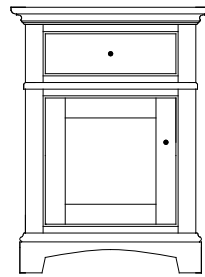

HM-1841 Night Stand
22½"w 30"h 17½"d
w/1 drawer, 1 door

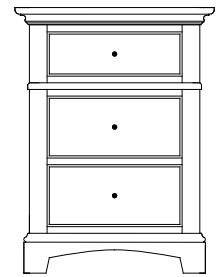

HM-1842 Night Stand
22½"w 30"h 17½"d
w/3 drawers

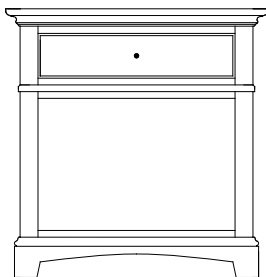

HM-1843 Night Stand
29¼"w 30"h 17½"d
w/1 drawer

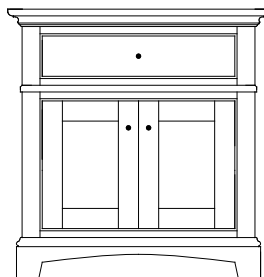

HM-1844 Night Stand
29¼"w 30"h 17½"d
w/1 drawer, 2 doors

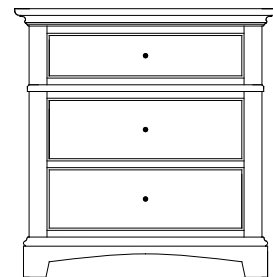

HM-1845 Night Stand
29¼"w 30"h 17½"d
w/3 drawers

Hamilton Lingeries & Chests



HM-1850
Chest shown

Available
with aromatic
cedar bottom

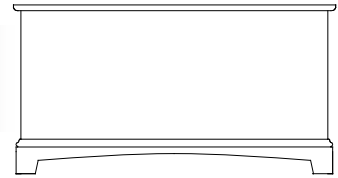

HM-1835 Blanket Chest
42"w 22"h 21½"d

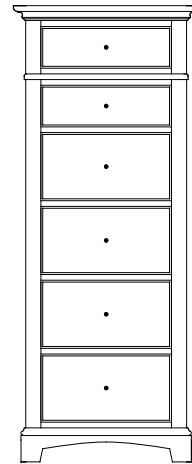

HM-1846 Lingerie
24½"w 60¼"h 21½"d
w/6 drawers



HM-1849 Chest
38½"w 36½"h 21½"d
w/4 drawers

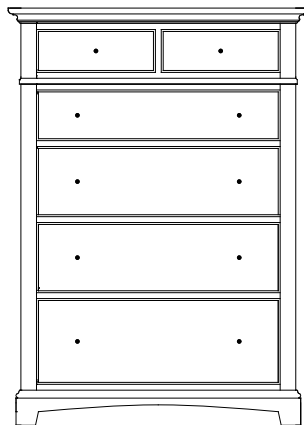

HM-1850 Chest
38½"w 53½"h 21½"d
w/6 drawers

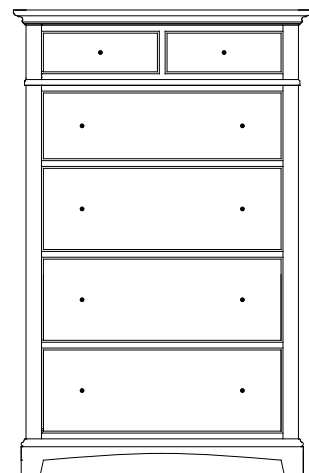

HM-1851 Hi-Boy
38½"w 60h 21½"d
w/6 drawers

Hamilton Dressers & Mirrors



HM-1856 Dresser shown with MI-1870 Mirror

MI-1870 Mirror
40"high 52"wide

MI-1871 Mirror
32"high 52"wide

MI-1872 Mirror
32"high 43"wide

MI-1873 Mirror
40"high 43"wide

Beveled Mirror

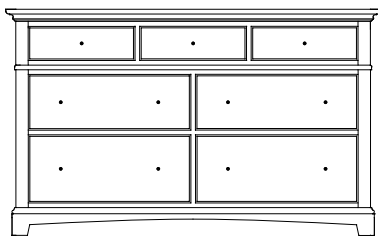

HM-1854 Dresser
60½"w 36½"h 21½"d
w/7 drawers

Suggested Mirrors:

MI-1873 Mirror
40"h 43"w

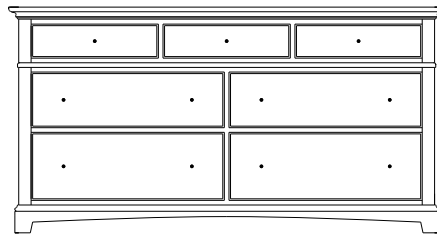

HM-1855 Dresser
70½"w 36½"h 21½"d
w/7 drawers

Suggested Mirrors:

MI-1870 Mirror
40"h 52"w

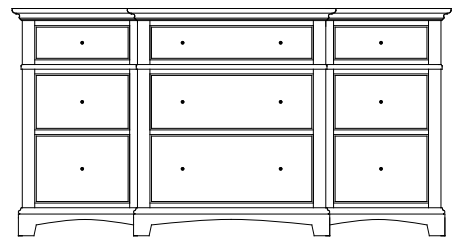

HM-1856 Dresser
69½"w 36½"h 21½"d
w/9 drawers

Suggested Mirrors:

MI-1870 Mirror
40"h 52"w

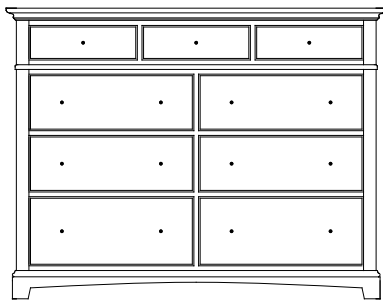

HM-1857 Tall Dresser
60½"w 46¼"h 21½"d
w/9 drawers

Suggested Mirrors:

MI-1872 Mirror
32"h 43"w

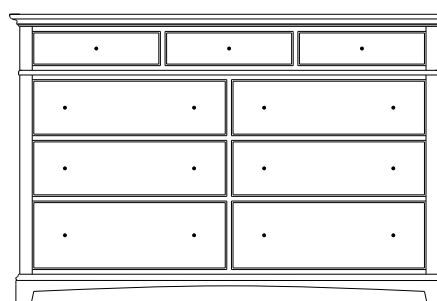

HM-1858 Tall Dresser
70½"w 46¼"h 21½"d
w/9 drawers

Suggested Mirrors:

MI-1871 Mirror
32"h 52"w

Hamilton Bed Frames



234-SR
Storage
Upgrade

shown with Regular Footboard

Hamilton Bed

Regular Footboard

Available
with underbed
storage options.

HM-1880-K (King)
82 3/4"w 86 1/8"l
HB 60"h ■ FB 22"h

HM-1880-Q (Queen)
67 1/4"w 86 1/8"l
HB 60"h ■ FB 22"h

HM-1880-F (Full)
60 1/8"w 81 1/8"l
HB 60"h ■ FB 22"h

HM-1880-T (Twin)
45 1/4"w 81 1/8"l
HB 60"h ■ FB 22"h

Low Footboard

HM-1882-K (King)
82 3/4"w 84 1/2"l
HB 60"h ■ FB 14 3/4"h

HM-1882-Q (Queen)
67 1/4"w 84 1/2"l
HB 60"h ■ FB 14 3/4"h

HM-1882-F (Full)
60 1/8"w 79 1/2"l
HB 60"h ■ FB 14 3/4"h

HM-1882-T (Twin)
45 1/4"w 79 1/2"l
HB 60"h ■ FB 14 3/4"h

Headboard Only

HM-1885-HB-K (King)
60" high

HM-1885-HB-Q (Queen)
60" high

HM-1885-HB-F (Full)
60" high

HM-1885-HB-T (Twin)
60" high

Hamilton Storage Rail Upgrades

12³/₄" From Floor to Box Spring

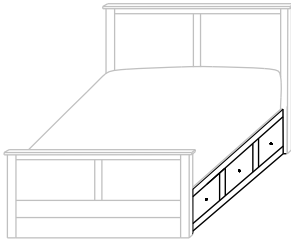

- With 3 drawers on each side
- 12³/₄" from floor to Box Spring
- Inside drawer dimensions on all sizes
9¹/₄"h 18⁷/₈"w 22¹/₂"d

532-SR-K King – 6 drawers
532-SR-Q Queen – 6 drawers
532-SR-F Full – 6 drawers
532-SR-T Twin – 3 drawers

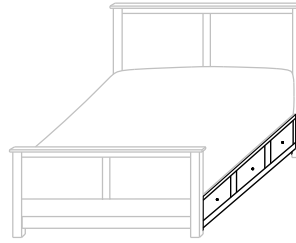

- With 3" Toe Kick
- With 3 drawers on each side
- 12³/₄" from floor to Box Spring
- Inside drawer dimensions on all sizes
6¹/₄"h 18⁷/₈"w 22¹/₂"d

234-SR-K King – 6 drawers
234-SR-Q Queen – 6 drawers
234-SR-F Full – 6 drawers
234-SR-T Twin – 3 drawers

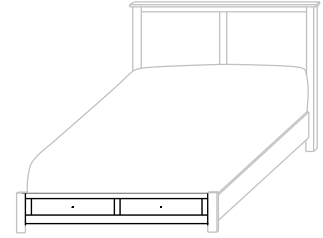

- 12³/₄" from floor to Box Spring
- Inside drawer dimensions
6¹/₄"h 22¹/₂"d
(King) 31" w (Queen) 23¹/₄" w
(Full) 19⁵/₈" w (Twin) 29¹/₄" w

685-FDS-K King – 2 drawers
685-FDS-Q Queen – 2 drawers
685-FDS-F Full – 2 drawers
685-FDS-T Twin – 1 drawer

19³/₄" From Floor to Box Spring

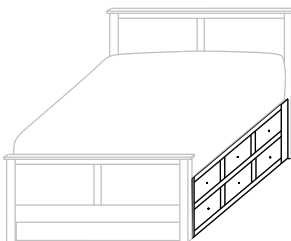

- With 6 drawers on each side
- Twin has 6 drawers on 1 side only
- 19³/₄" from floor to Box Spring
- Inside drawer dimensions on all sizes
6¹/₄"h 18⁷/₈"w 22¹/₂"d

654-SR-K King – 12 drawers
654-SR-Q Queen – 12 drawers
654-SR-F Full – 12 drawers
654-SR-T Twin – 6 drawers

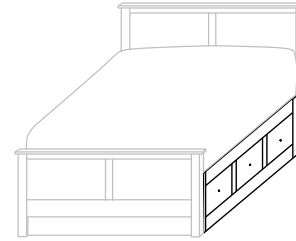

- With 3 drawers on each side
- 19³/₄" from floor to Box Spring
- Inside drawer dimensions on all sizes
10¹/₄"h 18⁷/₈"w 22¹/₂"d

325-SR-K King – 6 drawers
325-SR-Q Queen – 6 drawers
325-SR-F Full – 6 drawers
325-SR-T Twin – 3 drawers

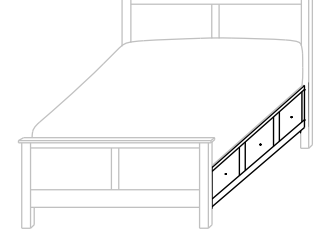

- With 7" Toe Kick
- With 3 drawers on each side
- 19³/₄" from floor to Box Spring
- Inside drawer dimensions on all sizes
9¹/₄"h 18⁷/₈"w 22¹/₂"d

236-SR-K King – 6 drawers
236-SR-Q Queen – 6 drawers
236-SR-F Full – 6 drawers
236-SR-T Twin – 3 drawers

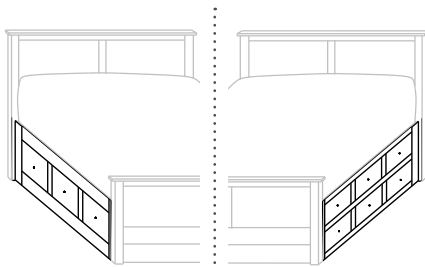

- With 3 drawers on one side and 6 drawers on other side
- 19³/₄" from floor to Box Spring

420-SR-K King – 9 drawers
420-SR-Q Queen – 9 drawers
420-SR-F Full – 9 drawers
 (Twin Not Available)

Additional Upgrades

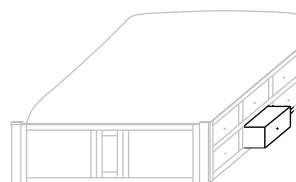

- With Step Stool Pullout in place of drawer

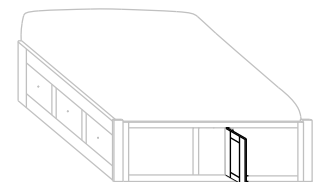

- With Door in Footboard to access area between rails





Lewiston
Bedroom Collection

Lewiston



Lewiston Bedroom Collection w/Lewiston Bed

- LN-2366Q Queen Bed
- LN-2311 Night Stand
- LN-2326 Chest
- LN-2330 Dresser
- MI-2370 Mirror

Shown above in **Brown Maple** with **OCS-135 Driftwood Low Sheen** and **K773-VB** hardware

Standard Features:



K773-VB pulls or
K558-VB Pulls



Standard with side-
mount drawer slides



Stained poplar
dovetailed drawers



Dovetailed bed slats

Available Upgrades:

- Any hardware on our Hardware Options Sheet
- Undermount soft close slides [See Price List]



- LN-2366Q Queen Bed
- LN-2311 Night Stand
- LN-2326 Chest
- LN-2330 Dresser
- MI-2370 Mirror

Shown in **Brown Maple**
with **OCS-133 Tundra**
and **K773-VB Hardware**

Lewiston Night Stands



LN-2311
Night Stand shown

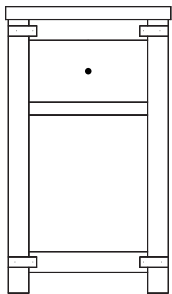

LN-2311 Night Stand
17"w 27¾"h 18¼"d
w/1 drawer

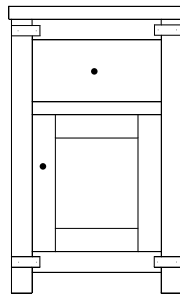

LN-2312 Night Stand
17"w 27¾"h 18¼"d
w/1 drawer, 1 door

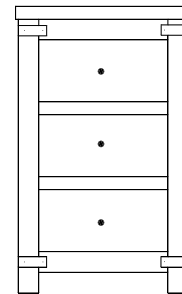

LN-2313 Night Stand
17"w 27¾"h 18¼"d
w/3 drawers

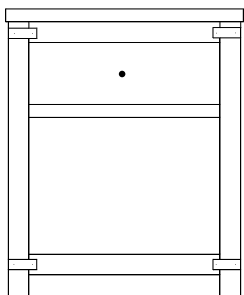

LN-2314 Night Stand
23"w 27¾"h 18¼"d
w/1 drawer

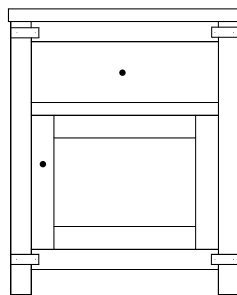

LN-2315 Night Stand
23"w 27¾"h 18¼"d
w/1 drawer, 1 door

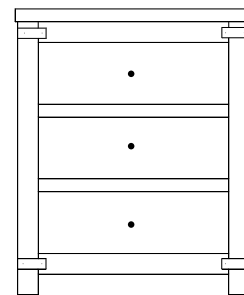

LN-2316 Night Stand
23"w 27¾"h 18¼"d
w/3 drawers

Lewiston Lingeries & Chests



LN-2326
Chest shown

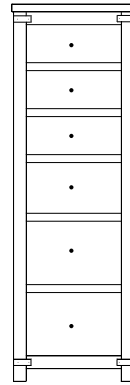

LN-2317 Lingerie
19½"w 59½"h 19¾"d
w/6 drawers

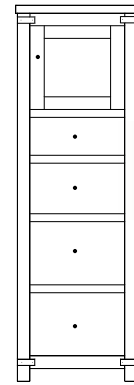

Available with
mirror in
door panel

LN-2318 Lingerie
19½"w 59½"h 19¾"d
w/4 drawers, 1 wood door,
1 adjustable shelf

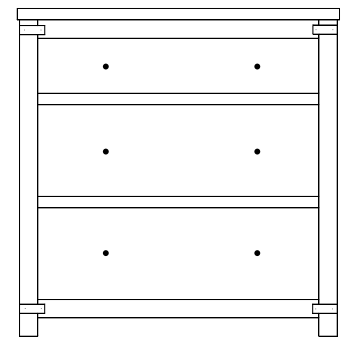

LN-2349 Chest
35¼"w 35¾"h 19¾"d
w/3 drawers

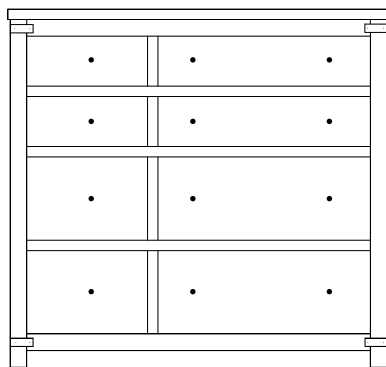

LN-2341 Chest
45¾"w 43"h 19¾"d
w/8 drawers

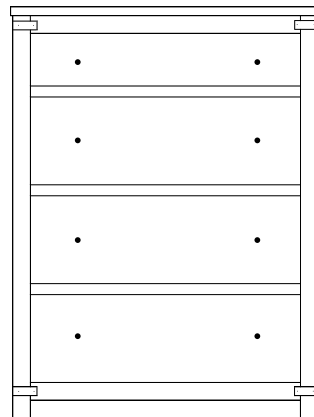

LN-2326 Chest
35¼"w 47"h 19¾"d
w/4 drawers

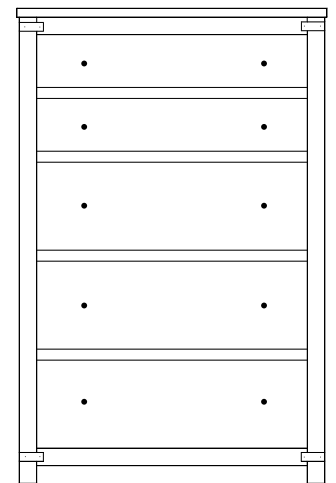

LN-2327 Hi-Boy
35¼"w 54¼"h 19¾"d
w/5 drawers

Lewiston Miscellaneous

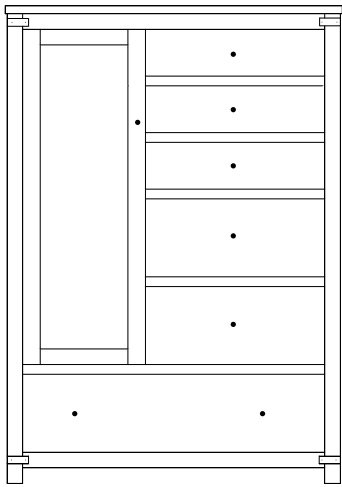

LN-2328 Chifferobe
43 $\frac{1}{4}$ "w 61 $\frac{1}{2}$ "h 19 $\frac{3}{4}$ "d
w/6 drawers, 1 door, 2 adj. shelves

Option:
Mirror on
back of door

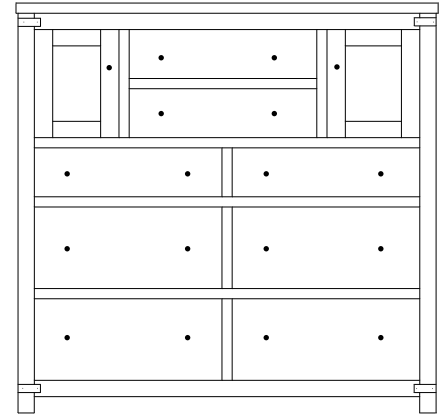

LN-2347 His & Hers
51 $\frac{3}{4}$ "w 50 $\frac{1}{4}$ "h 19 $\frac{3}{4}$ "d
w/8 drawers, 2 doors

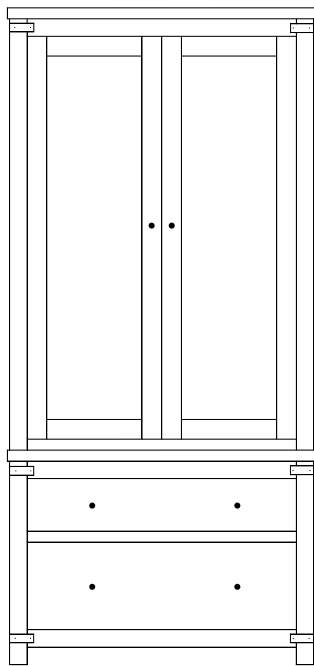

LN-2362 Armoire
35 $\frac{1}{4}$ "w 75"h 19 $\frac{3}{4}$ "d
w/2 drawers, (top drawer w/divider)
w/2 doors, 2 adj. shelves & closet rod

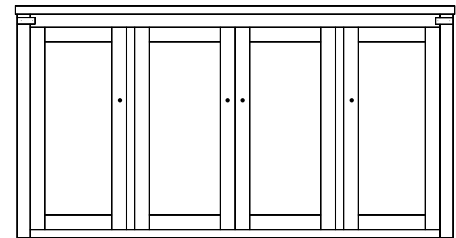

LN-2359 Chest Top
67 $\frac{1}{4}$ "w 35 $\frac{1}{2}$ "h 19 $\frac{3}{4}$ "d
w/4 doors & 6 adjustable shelves

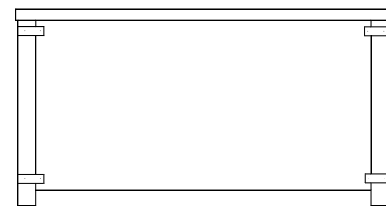

LN-2335 Blanket Chest
41"w 22"h 19 $\frac{3}{4}$ "d

Available
with aromatic
cedar bottom

Lewiston Dressers



LN-2330 Dresser shown with MI-2370 Mirror

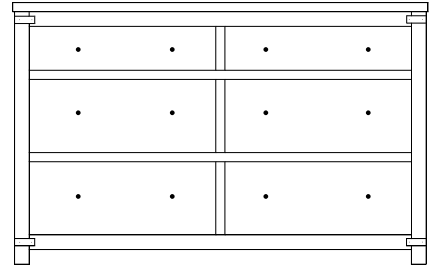

LN-2330 Dresser
56¾"w 35¾"h 19¾"d
w/6 drawers

Suggested Mirrors:

MI-2370 Mirror
40½"h 34½"w

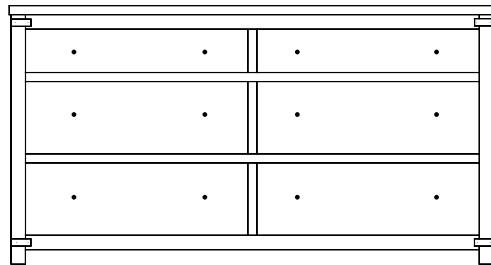

LN-2331 Dresser
67¼"w 35¾"h 19¾"d
w/6 drawers

Suggested Mirrors:

MI-2371 Mirror
40½"h 44½"w

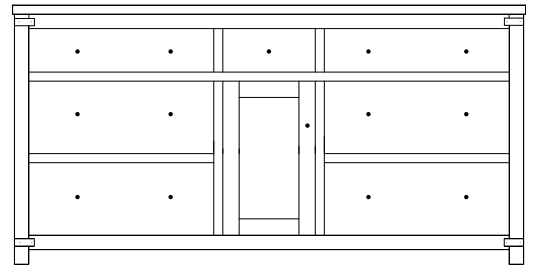

LN-2332 Dresser
70½"w 35¾"h 19¾"d
w/7 drawers, 1 door
w/1 adjustable shelf

Suggested Mirrors:

MI-2371 Mirror
40½"h 44½"w

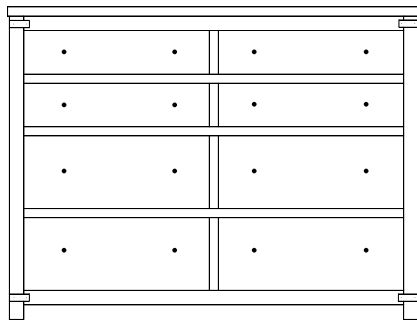

LN-2343 Dresser
56¾"w 43"h 19¾"d
w/8 drawers

Suggested Mirrors:

MI-2372 Mirror
32½"h 40½"w

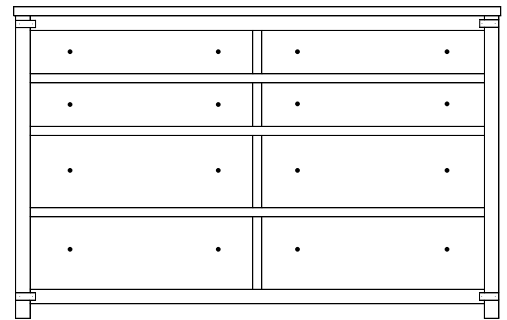

LN-2344 Dresser
67¼"w 43"h 19¾"d
w/8 drawers

Suggested Mirrors:

MI-2373 Mirror
32½"h 50½"w



MI-2370 Mirror
40½"h 34½"w

MI-2371 Mirror
40½"h 44½"w

MI-2372 Mirror
32½"h 40½"w

MI-2373 Mirror
32½"h 50½"w

Plain Mirror

Lewiston Bed Frames



shown with Low Footboard

Lewiston Bed

Regular Footboard

LN-2365-K (King)
80 $\frac{1}{8}$ "w 85 $\frac{1}{2}$ "l
HB 54"h ■ FB 30 $\frac{1}{4}$ "h

LN-2365-Q (Queen)
64 $\frac{1}{2}$ "w 85 $\frac{1}{2}$ "l
HB 54"h ■ FB 30 $\frac{1}{4}$ "h

LN-2365-F (Full)
57 $\frac{3}{8}$ "w 80 $\frac{1}{2}$ "l
HB 54"h ■ FB 30 $\frac{1}{4}$ "h

LN-2365-T (Twin)
42 $\frac{1}{2}$ "w 80 $\frac{1}{2}$ "l
HB 54"h ■ FB 30 $\frac{1}{4}$ "h

Available
with underbed
storage options.

Low Footboard

LN-2366-K (King)
80 $\frac{1}{8}$ "w 84 $\frac{1}{2}$ "l
HB 54"h ■ FB 16"h

LN-2366-Q (Queen)
64 $\frac{1}{2}$ "w 84 $\frac{1}{2}$ "l
HB 54"h ■ FB 16"h

LN-2366-F (Full)
57 $\frac{3}{8}$ "w 79 $\frac{1}{2}$ "l
HB 54"h ■ FB 16"h

LN-2366-T (Twin)
42 $\frac{1}{2}$ "w 79 $\frac{1}{2}$ "l
HB 54"h ■ FB 16"h

Headboard Only

LN-2367K-HB (King)
54" high

LN-2367Q-HB (Queen)
54" high

LN-2367F-HB (Full)
54" high

LN-2367T-HB (Twin)
54" high

Lewiston Storage Rail Upgrades

12³/₄" From Floor to Box Spring

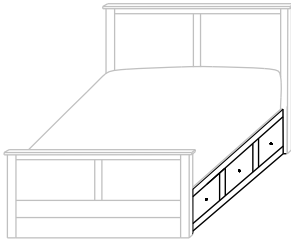

- With 3 drawers on each side
- 12³/₄" from floor to Box Spring
- Inside drawer dimensions on all sizes
9¹/₄"h 18⁷/₈"w 22¹/₂"d

532-SR-K King – 6 drawers
532-SR-Q Queen – 6 drawers
532-SR-F Full – 6 drawers
532-SR-T Twin – 3 drawers

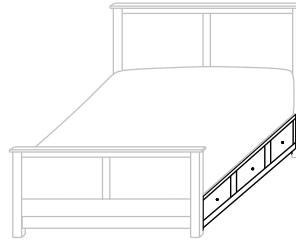

- With 3" Toe Kick
- With 3 drawers on each side
- 12³/₄" from floor to Box Spring
- Inside drawer dimensions on all sizes
6¹/₄"h 18⁷/₈"w 22¹/₂"d

234-SR-K King – 6 drawers
234-SR-Q Queen – 6 drawers
234-SR-F Full – 6 drawers
234-SR-T Twin – 3 drawers

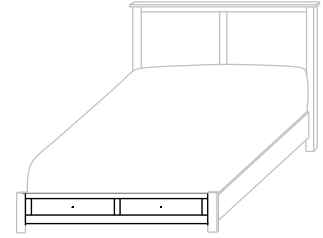

- 12³/₄" from floor to Box Spring
- Inside drawer dimensions
6¹/₄"h 22¹/₂"d
 (King) 31" w (Queen) 23¹/₄" w
 (Full) 19⁵/₈" w (Twin) 29¹/₄" w

685-FDS-K King – 2 drawers
685-FDS-Q Queen – 2 drawers
685-FDS-F Full – 2 drawers
685-FDS-T Twin – 1 drawer

19³/₄" From Floor to Box Spring

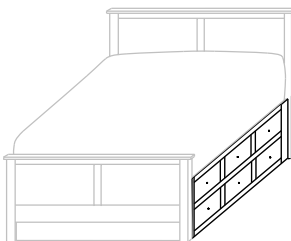

- With 6 drawers on each side
- Twin has 6 drawers on 1 side only
- 19³/₄" from floor to Box Spring
- Inside drawer dimensions on all sizes
6¹/₄"h 18⁷/₈"w 22¹/₂"d

654-SR-K King – 12 drawers
654-SR-Q Queen – 12 drawers
654-SR-F Full – 12 drawers
654-SR-T Twin – 6 drawers

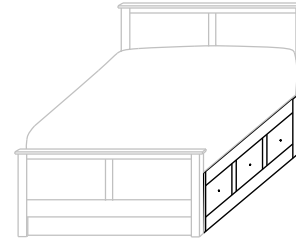

- With 3 drawers on each side
- 19³/₄" from floor to Box Spring
- Inside drawer dimensions on all sizes
10¹/₄"h 18⁷/₈"w 22¹/₂"d

325-SR-K King – 6 drawers
325-SR-Q Queen – 6 drawers
325-SR-F Full – 6 drawers
325-SR-T Twin – 3 drawers

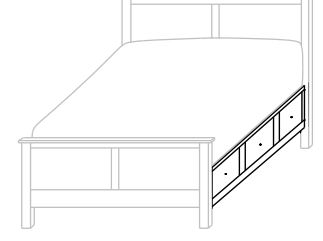

- With 7" Toe Kick
- With 3 drawers on each side
- 19³/₄" from floor to Box Spring
- Inside drawer dimensions on all sizes
9¹/₄"h 18⁷/₈"w 22¹/₂"d

236-SR-K King – 6 drawers
236-SR-Q Queen – 6 drawers
236-SR-F Full – 6 drawers
236-SR-T Twin – 3 drawers

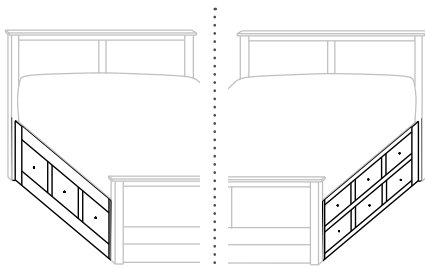

- With 3 drawers on one side and 6 drawers on other side
- 19³/₄" from floor to Box Spring

420-SR-K King – 9 drawers
420-SR-Q Queen – 9 drawers
420-SR-F Full – 9 drawers
 (Twin Not Available)

Additional Upgrades

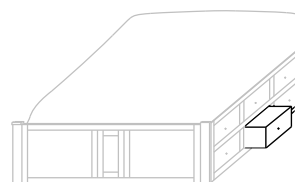

- With Step Stool Pullout in place of drawer

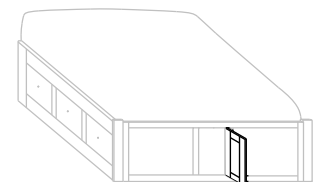

- With Door in Footboard to access area between rails





Luellen
Bedroom Collection

Luellen



Luellen Bedroom Collection w/Lindenhurst Sleigh Bed

- LH-1522Q Queen Bed
- LE-311 Night Stand
- LE-362 Chest
- LE-330 Dresser
- MI-2130 Mirror

Shown above in **Brown Maple** with **OCS-113 Michaels** and **1½" Wood Knobs**

Standard Features:



1½" Wood Knobs



Standard with side-mount drawer slides

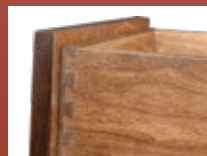

Stained poplar drawer boxes



Dovetailed bed slats

Available Upgrades:

- Any hardware on our Hardware Options Sheet
- Undermount soft close slides [See Price List]



- 2-LE-480T Twin Double Bow Beds
- 2-LE-313 Night Stands
- LE-365 Dresser
- MI-2130 Mirror

Shown in **Brown Maple** with **OCS-341 White** and **K810-MB Hardware**

Luellen Night Stands



LE-316
Night Stand shown



Sliding top option available on all night stands
(Hidden compartment w/Lock)

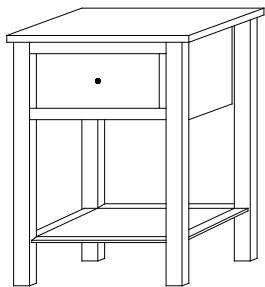

TB-61 Night Stand
20¼"w 27½"h 19¼"d
w/1 drawer

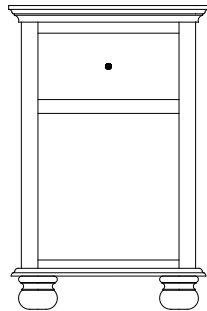

LE-311 Night Stand
18"w 28"h 19"d
w/1 drawer

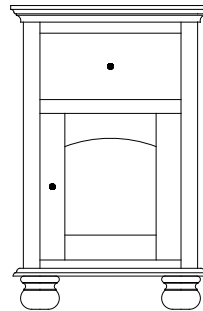

LE-312 Night Stand
18"w 28"h 19"d
w/1 drawer, 1 door

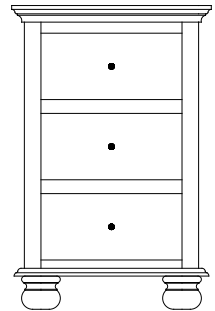

LE-313 Night Stand
18"w 28"h 19"d
w/3 drawers

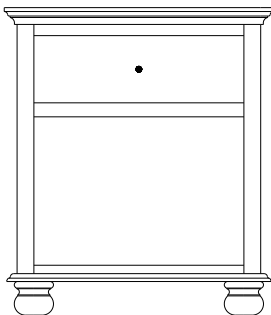

LE-314 Night Stand
24"w 28"h 19"d
w/1 drawer

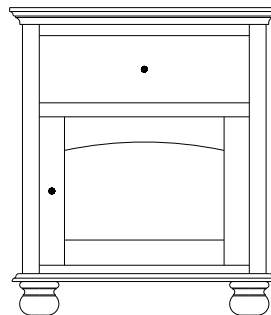

LE-315 Night Stand
24"w 28"h 19"d
w/1 drawer, 1 door

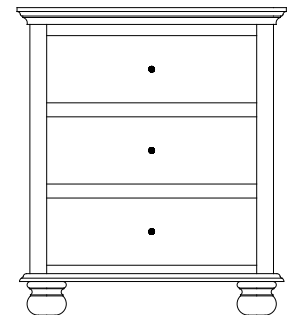

LE-316 Night Stand
24"w 28"h 19"d
w/3 drawers

Luellen Lingeries & Chests



LE-362
Chest shown

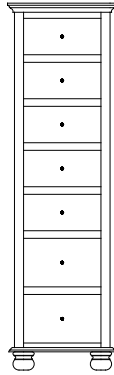

LE-317 Lingerie
18"w 61"h 21"d
w/7 drawers

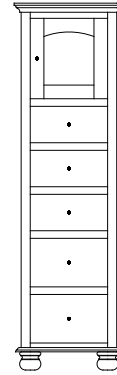

Available with
mirror panel
in door (LE-319)

LE-318 Lingerie
18"w 61"h 21"d
w/5 drawers, 1 wood door,
1 adjustable shelf

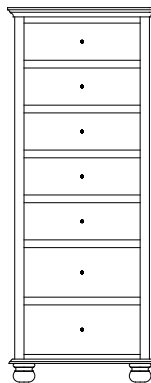

LE-320 Lingerie
24"w 61"h 21"d
w/7 drawers

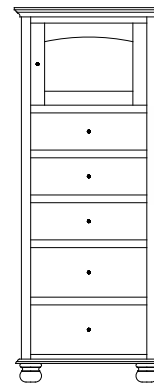

Available with
mirror panel
in door (LE-322)

LE-321 Lingerie
24"w 61"h 21"d
w/5 drawers, 1 wood door,
1 adjustable shelf

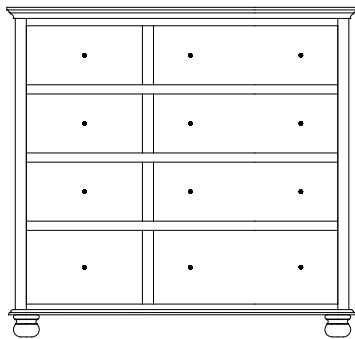

LE-341 Chest
48"w 45½"h 21"d
w/8 drawers

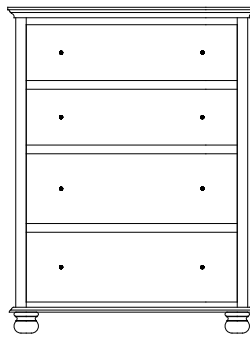

LE-326 Chest
36"w 47½"h 21"d
w/4 drawers

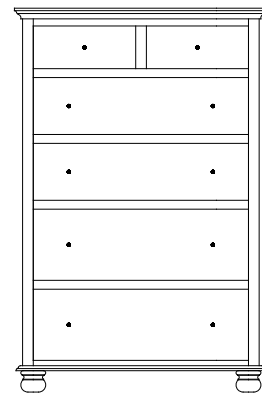

LE-362 Chest
36"w 54½"h 21"d
w/6 drawers

Luellen Miscellaneous

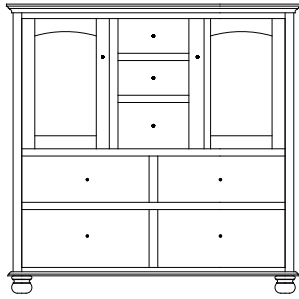

LE-347 His & Hers
51¼"w 50½"h 21"d
w/7 drawers, 2 doors, 2 adj. shelves

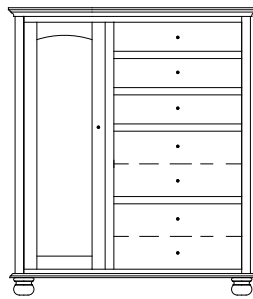

LE-328 Chifferobe
43¼"w 50"h 21"d
w/5 drawers, 1 door, 2 adj. shelves

Option:
Mirror on
back of door

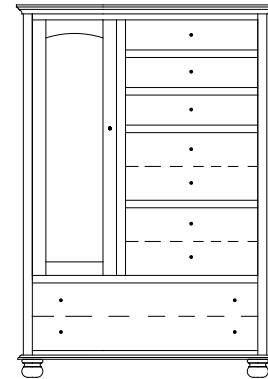

LE-329 Chifferobe
43¼"w 62½"h 21"d
w/6 drawers, 1 door, 2 adj. shelves

Option:
Mirror on
back of door

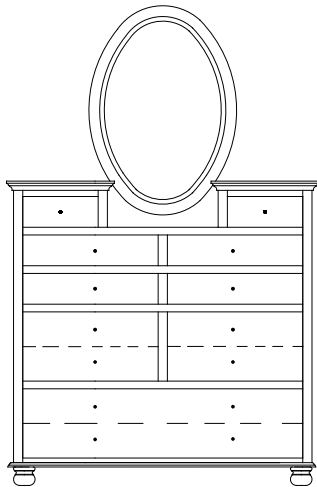

LE-336 Studio w/Mirror
51¼"w 80½"h 21"d
w/9 drawers

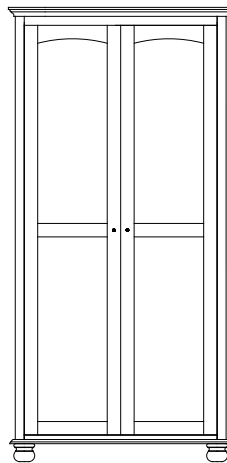

LE-359 Wardrobe
39"w 76½"h 25½"d
w/2 doors, closet rod

Option:
Adjustable shelves

Full width drawer
inside doors in
bottom of unit

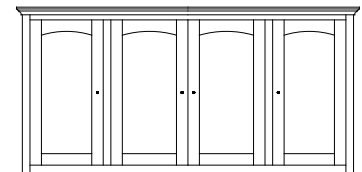

LE-35 Mule Chest Top
68¾"w 35½"h 21½"d
w/4 doors & 4 adjustable shelves

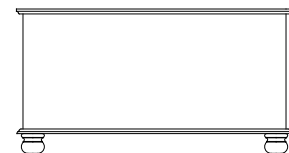

LE-364 Blanket Chest
42"w 22"h 21½"d

Available
with aromatic
cedar bottom

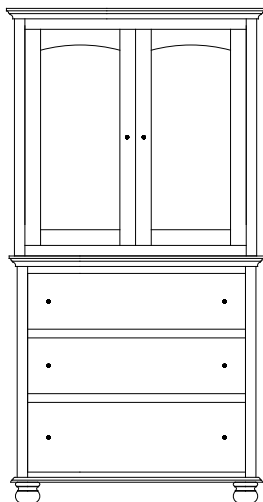

LE-25 Armoire Top
37"w 35½"h 21½"d
w/2 doors, 2 adj. shelves
w/1 wire hole in back

LE-323 Armoire Base
36"w 35½"h 21"d
w/3 drawers

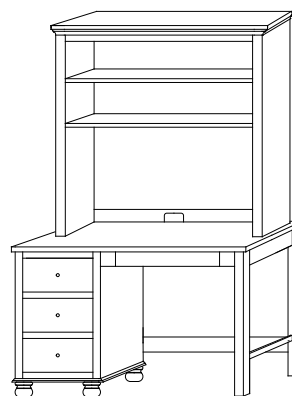

LE-397 Study Carrel
48"w 42"h 13"d
w/2 adjustable shelves

LE-399 Student Desk
48"w 29½"h 22½"d
w/3 drawers
w/1 pencil drawer

Upgrades available on student desk:

Keyboard slideout instead of pencil drawer
File drawer instead of bottom 2 drawers

Luellen Dressers



LE-330 Dresser shown with **MI-2130 Mirror**

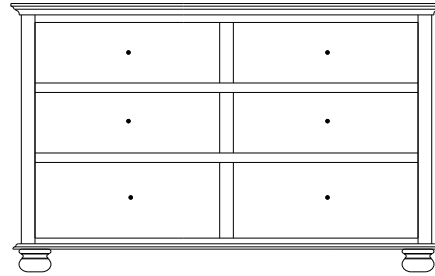

LE-330 Dresser
57¼"w 36"h 21"d
w/6 drawers

Suggested Mirrors:

MI-2131 Mirror
40"h 46"w

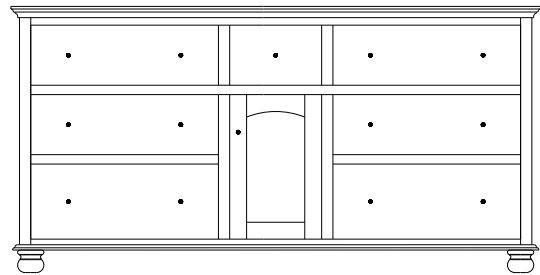

LE-332 Dresser
71"w 36"h 21"d
w/7 drawers, 1 door

Suggested Mirrors:

MI-2131 Mirror
40"h 46"w

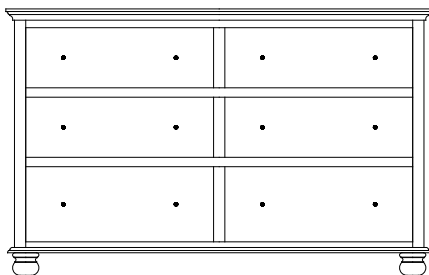

LE-331 Dresser
67¾"w 36"h 21"d
w/6 drawers

Suggested Mirrors:

MI-2131 Mirror
40"h 46"w

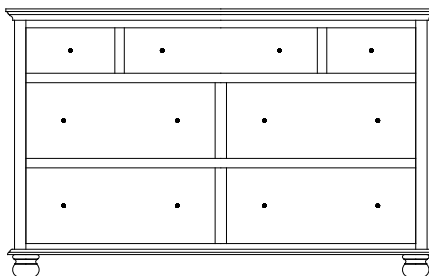

LE-363 Dresser
57¼"w 36"h 21"d
w/7 drawers

Suggested Mirrors:

MI-2130 Mirror
40"h 36"w

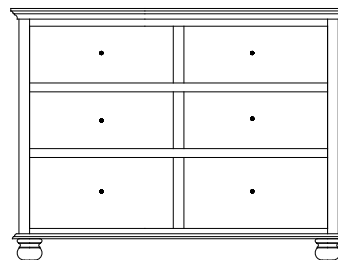

LE-365 Dresser
47¾"w 34"h 21"d
w/6 drawers

Suggested Mirrors:

MI-2130 Mirror
40"h 36"w

Luellen Dressers

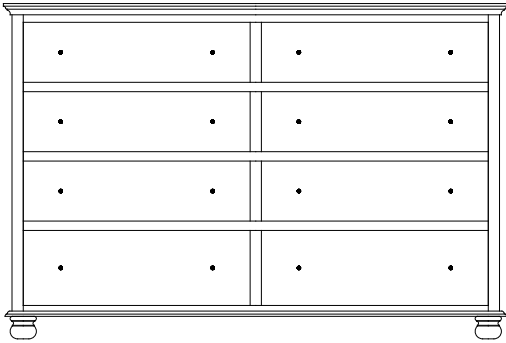

LE-334 Dresser
67 3/4"w 47 1/4"h 21"d
w/8 drawers

Suggested Mirrors:

MI-2133 Mirror
32"h 52"w

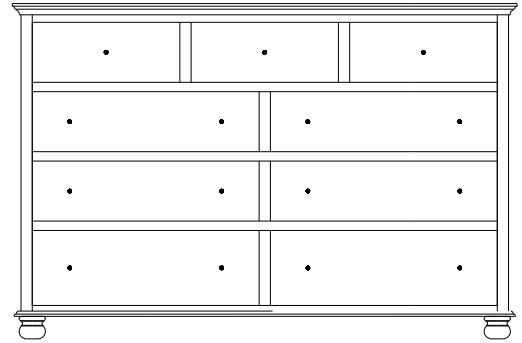

LE-344 Dresser
67 3/4"w 45 1/4"h 21"d
w/9 drawers

Suggested Mirrors:

MI-2133 Mirror
32"h 52"w

Luellen Mirror



MI-2130 Mirror
40"high 36"wide

MI-2131 Mirror
40"high 46"wide

MI-2132 Mirror
32"high 42"wide

MI-2133 Mirror
32"high 52"wide

Beveled Mirror

Luellen Bed Frames



shown with Regular Footboard



shown with Regular Footboard

Lindenhurst Sleigh Bed

Regular Footboard

Available with underbed storage options.

LH-1520-K (King)
79 1/8" w 89 1/4" l
HB 48" h ■ FB 30" h

LH-1520-Q (Queen)
63 5/8" w 89 1/4" l
HB 48" h ■ FB 30" h

LH-1520-F (Full)
56 3/8" w 85 1/4" l
HB 48" h ■ FB 30" h

LH-1520-T (Twin)
41 5/8" w 85 1/4" l
HB 48" h ■ FB 30" h

Low Footboard

LH-1522-K (King)
79 1/8" w 89 3/8" l
HB 48" h ■ FB 14 3/4" h

LH-1522-Q (Queen)
63 5/8" w 89 3/8" l
HB 48" h ■ FB 14 3/4" h

LH-1522-F (Full)
56 3/8" w 84 3/8" l
HB 48" h ■ FB 14 3/4" h

LH-1522-T (Twin)
41 5/8" w 84 3/8" l
HB 48" h ■ FB 14 3/4" h

Headboard Only

LH-1525-HB-K (King)
48" high

LH-1525-HB-Q (Queen)
48" high

LH-1525-HB-F (Full)
48" high

LH-1525-HB-T (Twin)
48" high

Double Bow Bed

Regular Footboard

Available with underbed storage options.

LE-480-K (King)
79 1/4" w 87" l
HB 47 1/4" h ■ FB 36 1/4" h

LE-480-Q (Queen)
63 1/2" w 87" l
HB 47 1/4" h ■ FB 36 1/4" h

LE-480-F (Full)
57" w 82" l
HB 47 1/4" h ■ FB 36 1/4" h

LE-480-T (Twin)
41 1/4" w 82" l
HB 47 1/4" h ■ FB 36 1/4" h

Low Footboard

LE-479-K (King)
79 1/4" w 85 3/4" l
HB 47 1/4" h ■ FB 14 3/4" h

LE-479-Q (Queen)
63 1/2" w 85 3/4" l
HB 47 1/4" h ■ FB 14 3/4" h

LE-479-F (Full)
57" w 80 3/4" l
HB 47 1/4" h ■ FB 14 3/4" h

LE-479-T (Twin)
41 1/4" w 80 3/4" l
HB 47 1/4" h ■ FB 14 3/4" h

Headboard Only

LE-478-HB-K (King)
47 1/4" high

LE-478-HB-Q (Queen)
47 1/4" high

LE-478-HB-F (Full)
47 1/4" high

LE-478-HB-T (Twin)
47 1/4" high

Luellen Storage Rail Upgrades

12³/₄" From Floor to Box Spring

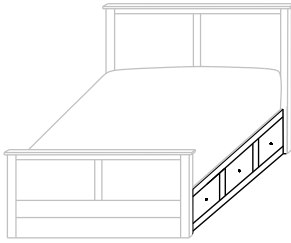

- With 3 drawers on each side
- 12³/₄" from floor to Box Spring
- Inside drawer dimensions on all sizes
9¹/₄"h 18⁷/₈"w 22¹/₂"d

532-SR-K King – 6 drawers
532-SR-Q Queen – 6 drawers
532-SR-F Full – 6 drawers
532-SR-T Twin – 3 drawers

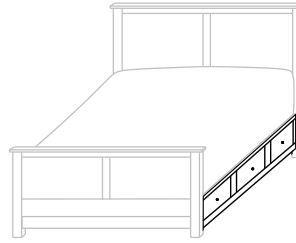

- With 3" Toe Kick
- With 3 drawers on each side
- 12³/₄" from floor to Box Spring
- Inside drawer dimensions on all sizes
6¹/₄"h 18⁷/₈"w 22¹/₂"d

234-SR-K King – 6 drawers
234-SR-Q Queen – 6 drawers
234-SR-F Full – 6 drawers
234-SR-T Twin – 3 drawers

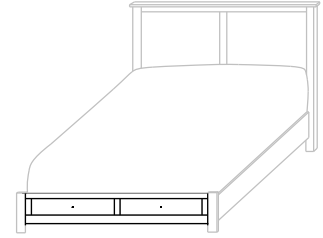

- 12³/₄" from floor to Box Spring
- Inside drawer dimensions
6¹/₄"h 22¹/₂"d
(King) 31" w (Queen) 23¹/₄" w
(Full) 19⁵/₈" w (Twin) 29¹/₄" w

685-FDS-K King – 2 drawers
685-FDS-Q Queen – 2 drawers
685-FDS-F Full – 2 drawers
685-FDS-T Twin – 1 drawer

19³/₄" From Floor to Box Spring

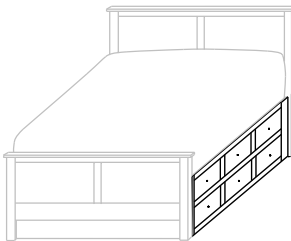

- With 6 drawers on each side
- Twin has 6 drawers on 1 side only
- 19³/₄" from floor to Box Spring
- Inside drawer dimensions on all sizes
6¹/₄"h 18⁷/₈"w 22¹/₂"d

654-SR-K King – 12 drawers
654-SR-Q Queen – 12 drawers
654-SR-F Full – 12 drawers
654-SR-T Twin – 6 drawers

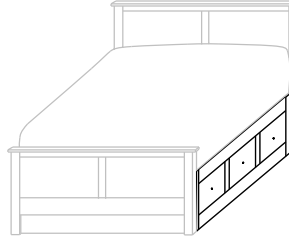

- With 3 drawers on each side
- 19³/₄" from floor to Box Spring
- Inside drawer dimensions on all sizes
10¹/₄"h 18⁷/₈"w 22¹/₂"d

325-SR-K King – 6 drawers
325-SR-Q Queen – 6 drawers
325-SR-F Full – 6 drawers
325-SR-T Twin – 3 drawers

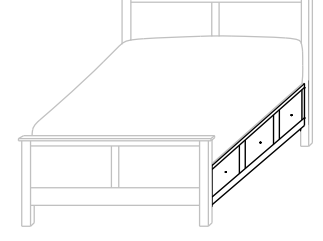

- With 7" Toe Kick
- With 3 drawers on each side
- 19³/₄" from floor to Box Spring
- Inside drawer dimensions on all sizes
9¹/₄"h 18⁷/₈"w 22¹/₂"d

236-SR-K King – 6 drawers
236-SR-Q Queen – 6 drawers
236-SR-F Full – 6 drawers
236-SR-T Twin – 3 drawers

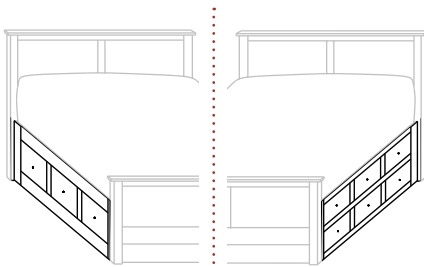

- With 3 drawers on one side and 6 drawers on other side
- 19³/₄" from floor to Box Spring

420-SR-K King – 9 drawers
420-SR-Q Queen – 9 drawers
420-SR-F Full – 9 drawers
 (Twin Not Available)

Additional Upgrades



- With Step Stool Pullout in place of drawer

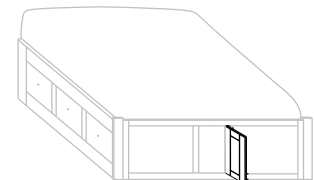

- With Door in Footboard to access area between rails





Manhattan
Bedroom Collection

Manhattan



Manhattan Bedroom Collection w/Manhattan Panel Bed

- MH-2175Q Queen Bed
- MH-2154 Dresser
- MH-2140 Night Stand
- MI-1665 Mirror
- MH-2150 Chest

Shown above in **Rustic Hickory** with **OCS-117 Asbury/OCS-110 Medium** and **4424-ORB Pulls & 4425-ORB Knob**

Standard Features:



4424-ORB Pulls &
4425-ORB Knobs



Standard with side-
mount drawer slides

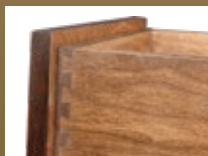

Stained poplar
drawer boxes



Reclaimed Barnwood
Tops and 2 Tone

Available Upgrades:

- Any hardware on our Hardware Options Sheet
- Undermount soft close slides [See Price List]



- MH-2171Q Manhattan Bed
- MH-2145 Night Stand
- MH-2150 Chest
- MH-2157 Dresser
- MI-2067 Mirror

Shown in *Rustic Hickory*
with *OCS-117 Asbury / OCS-110*
Medium and *4424-ORB Pulls*
and *4425-ORB Knobs*

Manhattan Night Stands



MH-2145
Night Stand shown



Sliding top option available on all night stands
(Hidden compartment w/Lock)

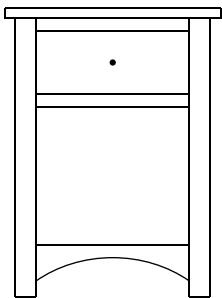

MH-2140 Night Stand
20 $\frac{3}{4}$ "w 27 $\frac{3}{4}$ "h 17 $\frac{1}{2}$ "d
w/1 drawer

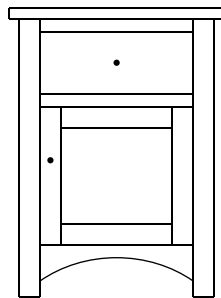

MH-2141 Night Stand
20 $\frac{3}{4}$ "w 27 $\frac{3}{4}$ "h 17 $\frac{1}{2}$ "d
w/1 drawer, 1 door

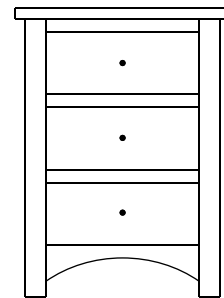

MH-2142 Night Stand
20 $\frac{3}{4}$ "w 27 $\frac{3}{4}$ "h 17 $\frac{1}{2}$ "d
w/3 drawers

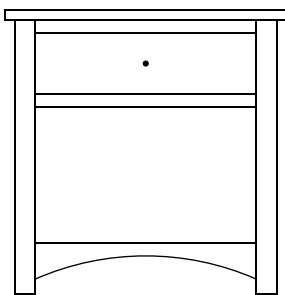

MH-2143 Night Stand
27 $\frac{1}{2}$ "w 27 $\frac{3}{4}$ "h 17 $\frac{1}{2}$ "d
w/1 drawer

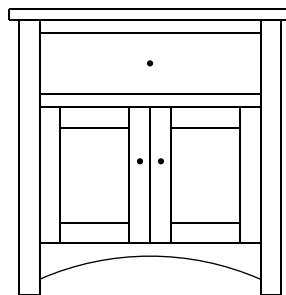

MH-2144 Night Stand
27 $\frac{1}{2}$ "w 27 $\frac{3}{4}$ "h 17 $\frac{1}{2}$ "d
w/1 drawer, 2 doors

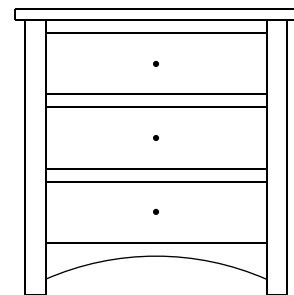

MH-2145 Night Stand
27 $\frac{1}{2}$ "w 27 $\frac{3}{4}$ "h 17 $\frac{1}{2}$ "d
w/3 drawers

Manhattan Lingeries & Chests



MH-2150
Chest shown

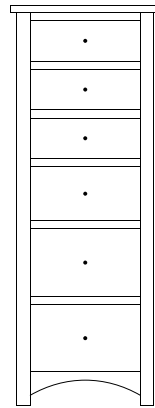

MH-2146 Lingerie
22³/₈"w 59¹/₂"h 21¹/₂"d
w/6 drawers

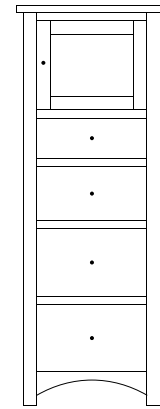

Available with
mirror panel
in door

MH-2147 Lingerie
22³/₈"w 59¹/₂"h 21¹/₂"d
w/4 drawers, 1 wood door,
1 adjustable shelf

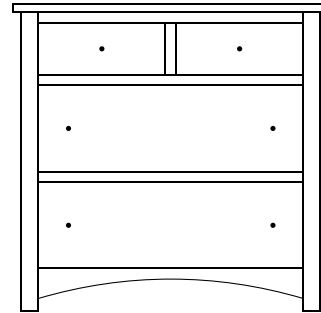

MH-2149 Chest
36³/₄"w 35³/₄"h 21¹/₂"d
w/4 drawers

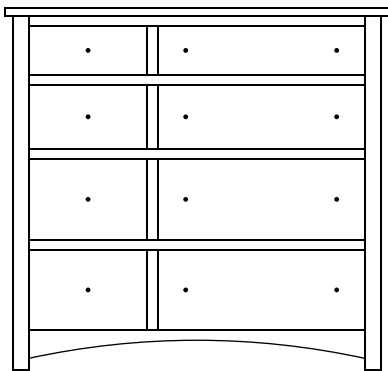

MH-2148 Chest
47³/₄"w 45"h 21¹/₂"d
w/8 drawers

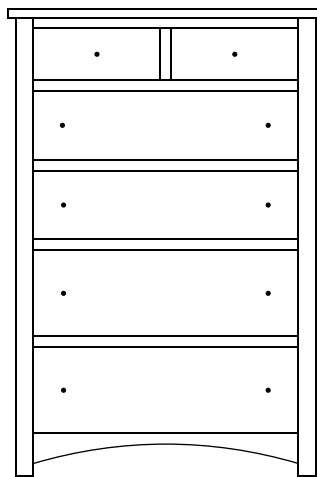

MH-2150 Chest
36³/₄"w 54¹/₄"h 21¹/₂"d
w/6 drawers

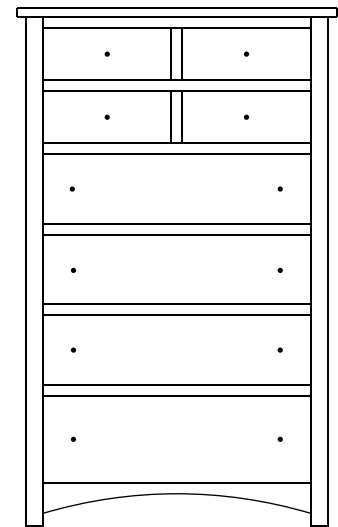

MH-2151 Hi-Boy
36³/₄"w 59¹/₂"h 21¹/₂"d
w/8 drawers

Manhattan Miscellaneous

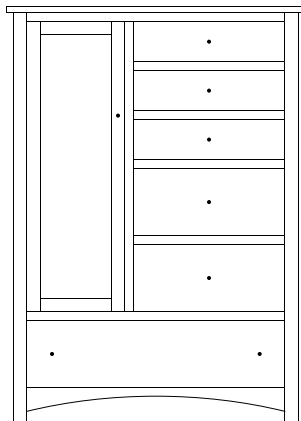

Option:
Mirror on
back of door

MH-2152 Chifferobe
44 1/4"w 61 1/2"h 21 1/2"d
w/6 drawers, 1 door, 2 adj. shelves

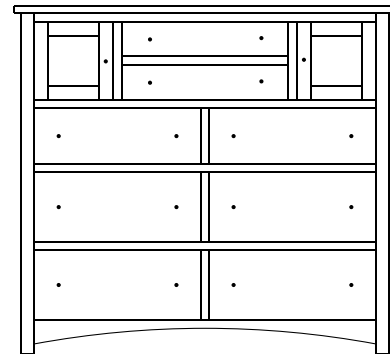

MH-2153 His & Hers
55 1/4"w 50 1/4"h 21 1/2"d
w/8 drawers, 2 doors

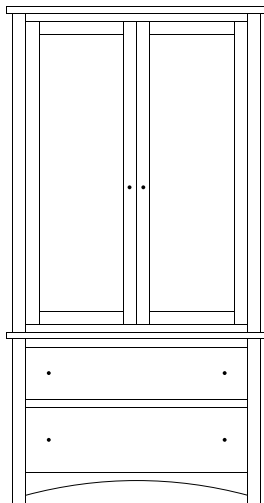

MH-2162 Armoire
40"w 76 1/4"h 21 1/2"d
w/2 drawers, (top drawer w/divider)
w/2 doors, 2 adj. shelves & closet rod

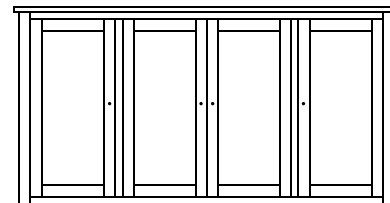

MH-2159 Mule Chest Top
68 3/4"w 35"h 21 1/2"d
w/4 doors & 6 adjustable shelves

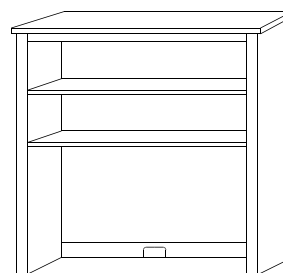

MH-2197 Study Carrel
48"w 42"h 13"d
w/2 adjustable shelves

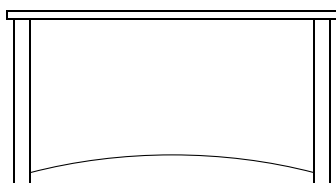

MH-2135 Blanket Chest
42"w 22"h 21 1/2"d

Available
with aromatic
cedar bottom

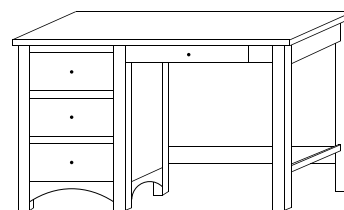

MH-2199 Student Desk
48"w 29 1/4"h 22 1/2"d
w/3 drawers
w/1 pencil drawer

Upgrades available on student desk:

Keyboard slideout instead of pencil drawer
File drawer instead of bottom 2 drawers

Manhattan Dressers



MH-2158 Dresser shown with MI-1668 Mirror

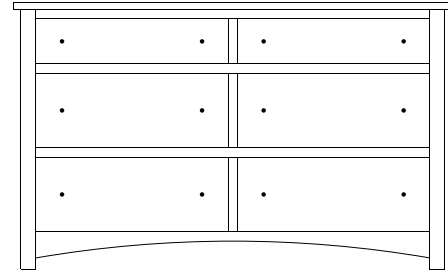

MH-2154 Dresser
58 $\frac{3}{4}$ "w 35 $\frac{3}{4}$ "h 21 $\frac{1}{2}$ "d
w/6 drawers

Suggested Mirrors:

MI-1665 Mirror
40"h 36"w

MI-2065 Mirror
40"h 36"w

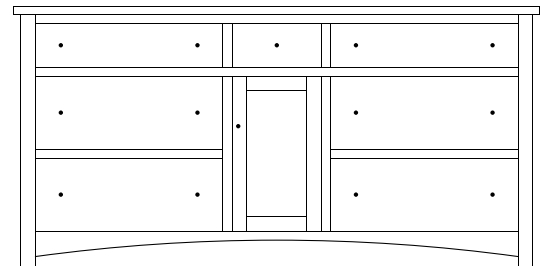

MH-2156 Dresser
72 $\frac{1}{4}$ "w 35 $\frac{3}{4}$ "h 21 $\frac{1}{2}$ "d
w/7 drawers, 1 door,
1 adjustable shelf

Suggested Mirrors:

MI-1666 Mirror
40"h 46"w

MI-2066 Mirror
40"h 46"w

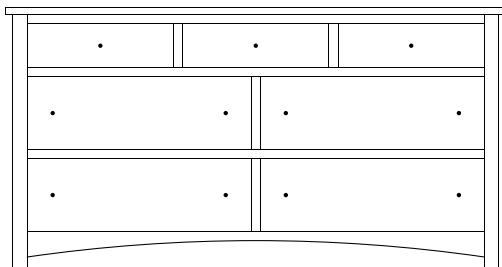

MH-2155 Dresser
68 $\frac{3}{4}$ "w 35 $\frac{3}{4}$ "h 21 $\frac{1}{2}$ "d
w/7 drawers

Suggested Mirrors:

MI-1666 Mirror
40"h 46"w

MI-2066 Mirror
40"h 46"w

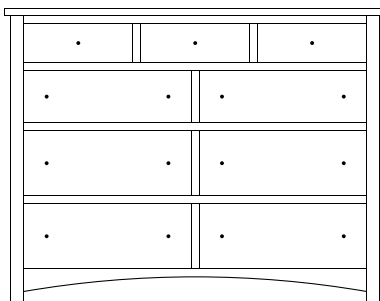

MH-2157 Dresser
58 $\frac{3}{4}$ "w 45"h 21 $\frac{1}{2}$ "d
w/9 drawers

Suggested Mirrors:

MI-1667 Mirror
32"h 42"w

MI-2067 Mirror
32"h 42"w

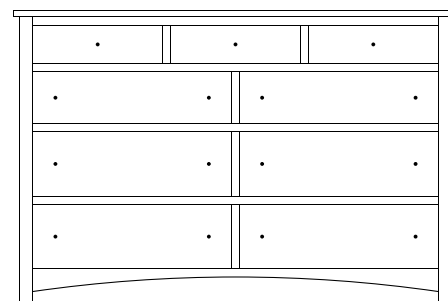

MH-2158 Dresser
68 $\frac{3}{4}$ "w 45"h 21 $\frac{1}{2}$ "d
w/9 drawers

Suggested Mirrors:

MI-1668 Mirror
32"h 52"w

Manhattan Mirrors



Beveled Mirror

MI-1665 Mirror
40"high 36"wide

MI-1666 Mirror
40"high 46"wide

MI-1667 Mirror
32"high 42"wide

MI-1668 Mirror
32"high 52"wide



Beveled Mirror

MI-2065 Mirror
40"high 36"wide

MI-2066 Mirror
40"high 46"wide

MI-2067 Mirror
32"high 42"wide

MI-2068 Mirror
32"high 52"wide

Manhattan Bed Frames



shown with Regular Footboard



shown with Regular Footboard

Manhattan Curved Bed

Available with underbed storage options.

Regular Footboard

MH-2171-K (King)
82½" w 87" l
HB 59¼" h ■ FB 30¼" h

MH-2171-Q (Queen)
66½" w 87" l
HB 57¼" h ■ FB 30¼" h

MH-2171-F (Full)
59¾" w 82" l
HB 55¾" h ■ FB 30¼" h

MH-2171-T (Twin)
44½" w 82" l
HB 53¾" h ■ FB 30¼" h

Low Footboard

MH-2178-K (King)
82½" w 85¾" l
HB 59¼" h ■ FB 14¾" h

MH-2178-Q (Queen)
66½" w 85¾" l
HB 57¼" h ■ FB 14¾" h

MH-2178-F (Full)
59¾" w 80¾" l
HB 55¾" h ■ FB 14¾" h

MH-2178-T (Twin)
44½" w 80¾" l
HB 53¾" h ■ FB 14¾" h

Headboard Only

MH-2170K-HB (King)
59¼" high

MH-2170Q-HB (Queen)
57¼" high

MH-2170F-HB (Full)
55¾" high

MH-2170T-HB (Twin)
53¾" high

Manhattan Panel Bed

Available with underbed storage options.

Regular Footboard

MH-2174-K (King)
82½" w 86½" l
HB 53" h ■ FB 30" h

MH-2174-Q (Queen)
66½" w 86½" l
HB 53" h ■ FB 30" h

MH-2174-F (Full)
59¾" w 81½" l
HB 53" h ■ FB 30" h

MH-2174-T (Twin)
44½" w 81½" l
HB 53" h ■ FB 30" h

Low Footboard

MH-2175-K (King)
82½" w 85½" l
HB 53" h ■ FB 14¾" h

MH-2175-Q (Queen)
66½" w 85½" l
HB 53" h ■ FB 14¾" h

MH-2175-F (Full)
59¾" w 80½" l
HB 53" h ■ FB 14¾" h

MH-2175-T (Twin)
44½" w 80½" l
HB 53" h ■ FB 14¾" h

Headboard Only

MH-2173K-HB (King)
53" high

MH-2173Q-HB (Queen)
53" high

MH-2173F-HB (Full)
53" high

MH-2173T-HB (Twin)
53" high

Manhattan Storage Rail Upgrades

12³/₄" From Floor to Box Spring

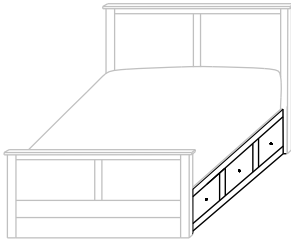

- With 3 drawers on each side
- 12³/₄" from floor to Box Spring
- Inside drawer dimensions on all sizes
9¹/₄"h 18⁷/₈"w 22¹/₂"d

532-SR-K King – 6 drawers
532-SR-Q Queen – 6 drawers
532-SR-F Full – 6 drawers
532-SR-T Twin – 3 drawers

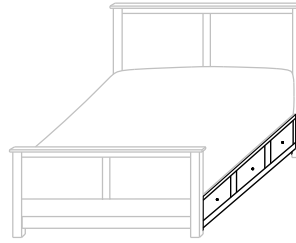

- With 3" Toe Kick
- With 3 drawers on each side
- 12³/₄" from floor to Box Spring
- Inside drawer dimensions on all sizes
6¹/₄"h 18⁷/₈"w 22¹/₂"d

234-SR-K King – 6 drawers
234-SR-Q Queen – 6 drawers
234-SR-F Full – 6 drawers
234-SR-T Twin – 3 drawers

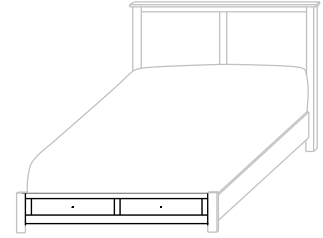

- 12³/₄" from floor to Box Spring
- Inside drawer dimensions
6¹/₄"h 22¹/₂"d
(King) 31" w (Queen) 23¹/₄" w
(Full) 19⁵/₈" w (Twin) 29¹/₄" w

685-FDS-K King – 2 drawers
685-FDS-Q Queen – 2 drawers
685-FDS-F Full – 2 drawers
685-FDS-T Twin – 1 drawer

19³/₄" From Floor to Box Spring

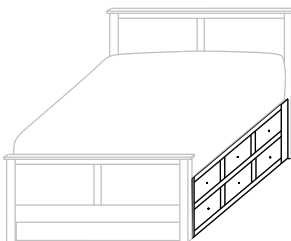

- With 6 drawers on each side
- Twin has 6 drawers on 1 side only
- 19³/₄" from floor to Box Spring
- Inside drawer dimensions on all sizes
6¹/₄"h 18⁷/₈"w 22¹/₂"d

654-SR-K King – 12 drawers
654-SR-Q Queen – 12 drawers
654-SR-F Full – 12 drawers
654-SR-T Twin – 6 drawers

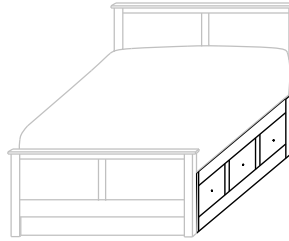

- With 3 drawers on each side
- 19³/₄" from floor to Box Spring
- Inside drawer dimensions on all sizes
10¹/₄"h 18⁷/₈"w 22¹/₂"d

325-SR-K King – 6 drawers
325-SR-Q Queen – 6 drawers
325-SR-F Full – 6 drawers
325-SR-T Twin – 3 drawers

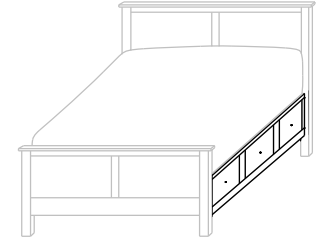

- With 7" Toe Kick
- With 3 drawers on each side
- 19³/₄" from floor to Box Spring
- Inside drawer dimensions on all sizes
9¹/₄"h 18⁷/₈"w 22¹/₂"d

236-SR-K King – 6 drawers
236-SR-Q Queen – 6 drawers
236-SR-F Full – 6 drawers
236-SR-T Twin – 3 drawers

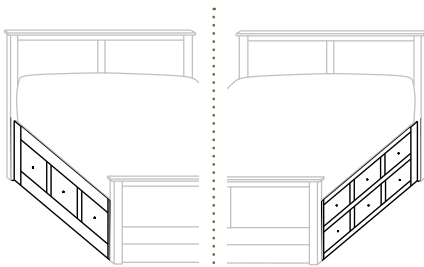

- With 3 drawers on one side and 6 drawers on other side
- 19³/₄" from floor to Box Spring

420-SR-K King – 9 drawers
420-SR-Q Queen – 9 drawers
420-SR-F Full – 9 drawers
 (Twin Not Available)

Additional Upgrades

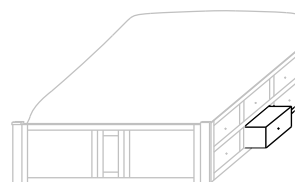

- With Step Stool Pullout in place of drawer

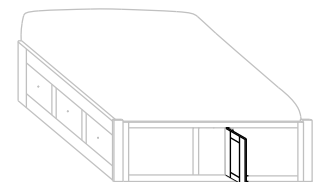

- With Door in Footboard to access area between rails





Olde Cottage
Bedroom Collection

Olde Cottage



Olde Cottage Bedroom Collection

- OD-2765Q Queen Bed
- OD-2741 Night Stand
- OD-2750 Chest
- OD-2746 Lingerie
- OD-2754 Dresser
- MI-2730 Mirror

Shown above in **Sap Cherry** with **OCS-113 Micheal's** and **53012-G10 Hardware**

Standard Features:



53012-G10 Hardware



Standard with side-mount drawer slides

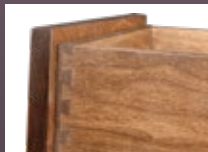

Stained poplar dovetailed drawers



Dovetailed bed slats

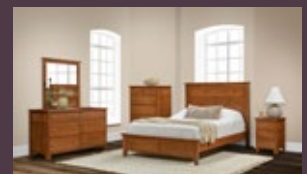

- OD-2765Q Queen Bed
- SH-2742 Night Stand
- SH-2750 Chest
- SH-2754 Dresser
- MI-2730 Mirror

Shown in **Sap Cherry** with **OCS-104 Seely** and **53012-G10 Hardware**

Available Upgrades:

- Any hardware on our Hardware Options Sheet
- Undermount soft close slides [See Price List]

Olde Cottage Night Stands



OD-2742
Night Stand shown

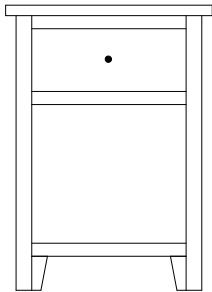

OD-2740 Night Stand
19 $\frac{3}{4}$ "w 27 $\frac{1}{4}$ "h 17 $\frac{1}{2}$ "d
w/1 drawer

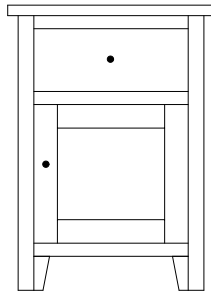

OD-2741 Night Stand
19 $\frac{3}{4}$ "w 27 $\frac{1}{4}$ "h 17 $\frac{1}{2}$ "d
w/1 drawer & 1 door

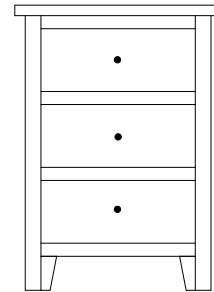

OD-2742 Night Stand
19 $\frac{3}{4}$ "w 27 $\frac{1}{4}$ "h 17 $\frac{1}{2}$ "d
w/3 drawers

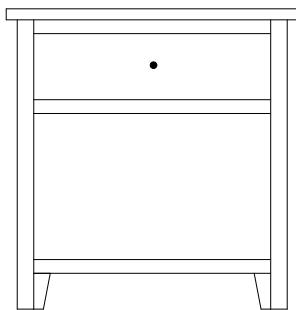

OD-2743 Night Stand
26 $\frac{1}{2}$ "w 27 $\frac{1}{4}$ "h 17 $\frac{1}{2}$ "d
w/1 drawer

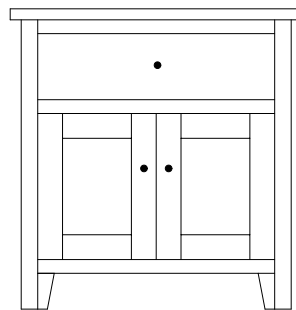

OD-2744 Night Stand
26 $\frac{1}{2}$ "w 27 $\frac{1}{4}$ "h 17 $\frac{1}{2}$ "d
w/1 drawer, 2 doors

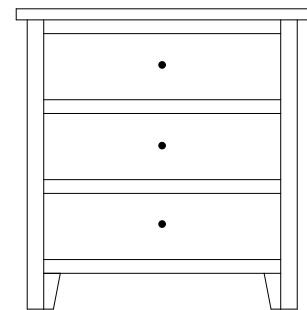

OD-2745 Night Stand
26 $\frac{1}{2}$ "w 27 $\frac{1}{4}$ "h 17 $\frac{1}{2}$ "d
w/3 drawers

Olde Cottage Lingeries & Chests



OD-2750
Chest shown

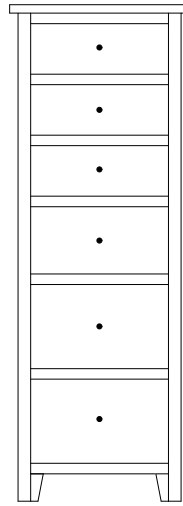

OD-2746 Lingerie
21 $\frac{3}{8}$ "w 59"h 21 $\frac{1}{2}$ "d
w/6 drawers

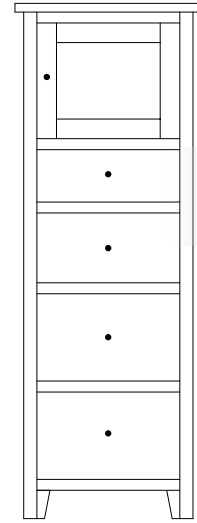

Available with
mirror in
door panel

OD-2747 Lingerie
21 $\frac{3}{8}$ "w 59"h 21 $\frac{1}{2}$ "d
w/4 drawers, 1 wood door,
1 adjustable shelf

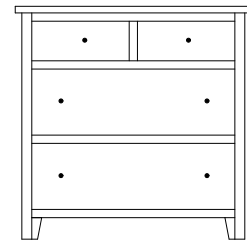

OD-2749 Chest
35 $\frac{3}{4}$ "w 35 $\frac{1}{4}$ "h 21 $\frac{1}{2}$ "d
w/4 drawers

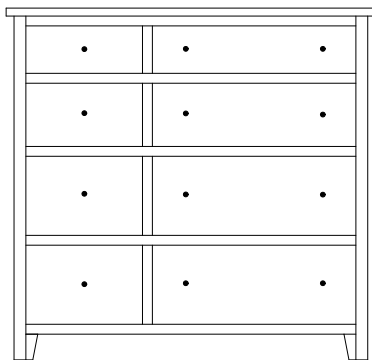

OD-2748 Chest
46 $\frac{3}{4}$ "w 44 $\frac{1}{2}$ "h 21 $\frac{1}{2}$ "d
w/8 drawers

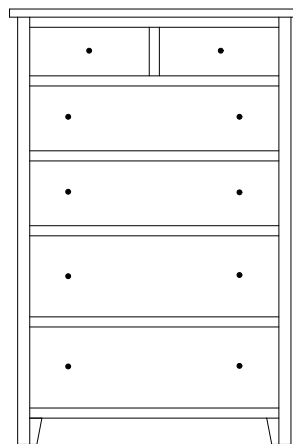

OD-2750 Chest
35 $\frac{3}{4}$ "w 53 $\frac{3}{4}$ "h 21 $\frac{1}{2}$ "d
w/6 drawers

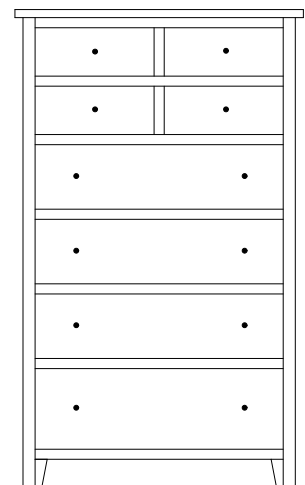

OD-2751 Hi-Boy
35 $\frac{3}{4}$ "w 59"h 21 $\frac{1}{2}$ "d
w/8 drawers

Olde Cottage Miscellaneous

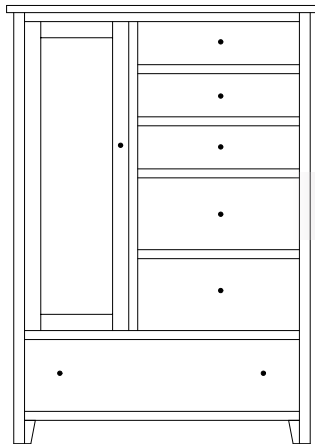

Option:
Mirror on
back of door

OD-2752 Chifferobe
43¼"w 61"h 21½"d
w/6 drawers, 1 door, 2 adj. shelves

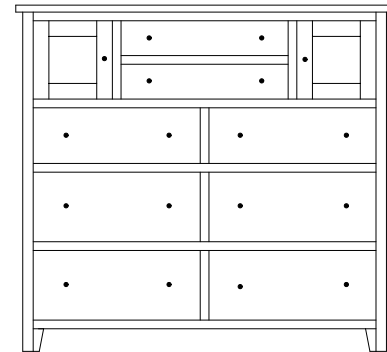

OD-2753 His & Hers Chest
54¼"w 49¾"h 21½"d
w/8 drawers, 2 doors

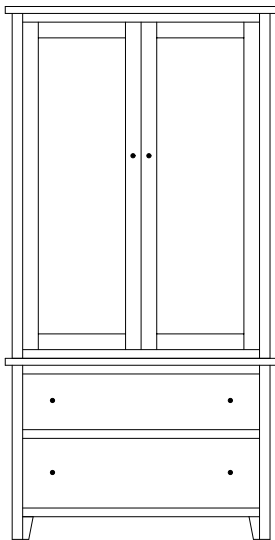

OD-2762 Armoire
39"w 76¼"h 21½"d
w/2 drawers, w/2 doors,
2 adj. shelves & closet rod

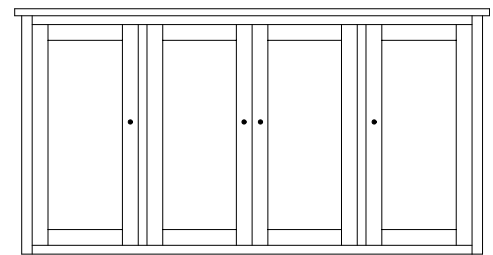

OD-2759 Mule Chest Top
67¾"w 35"h 21½"d
w/4 doors & 6 adjustable shelves

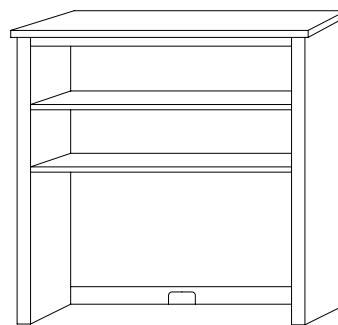

OD-2797 Study Carrel
48"w 42"h 13"d
w/2 adjustable shelves

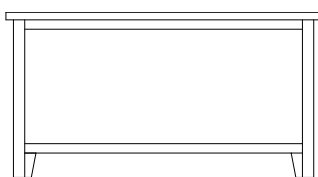

OD-2735 Blanket Chest
42"w 22"h 21½"d

Available
with aromatic
cedar bottom

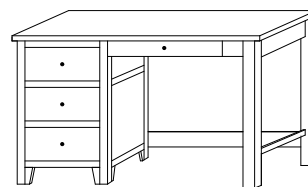

OD-2799 Student Desk
48"w 28¾"h 23"d
w/3 drawers
w/1 pencil drawer

Upgrades available on student desk:

Keyboard slideout instead of pencil drawer
File drawer instead of bottom 2 drawers

Olde Cottage Dressers



OD-2754 Dresser shown with **MI-2730 Mirror**

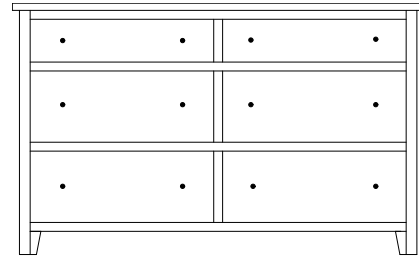

OD-2754 Dresser
57 $\frac{3}{4}$ "w 35 $\frac{1}{4}$ "h 21 $\frac{1}{2}$ "d
w/6 drawers

Suggested Mirrors:

MI-2730 Mirror
40"h 36"w

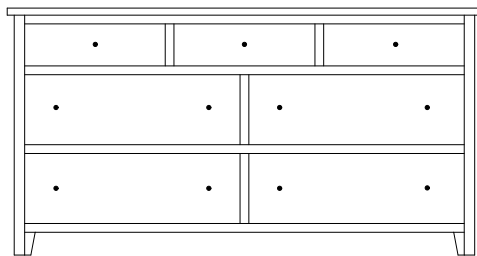

OD-2755 Dresser
67 $\frac{3}{4}$ "w 35 $\frac{1}{4}$ "h 21 $\frac{1}{2}$ "d
w/7 drawers

Suggested Mirrors:

MI-2731 Mirror
40"h 46"w

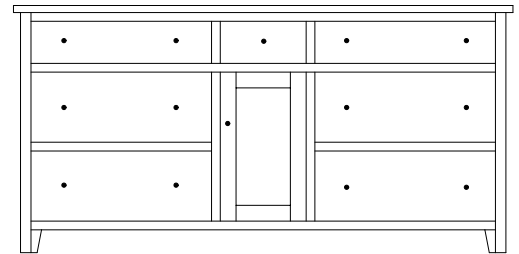

OD-2756 Dresser
71 $\frac{1}{4}$ "w 35 $\frac{1}{4}$ "h 21 $\frac{1}{2}$ "d
w/7 drawers, 1 door
w/1 adjustable shelf

Suggested Mirrors:

MI-2731 Mirror
40"h 46"w

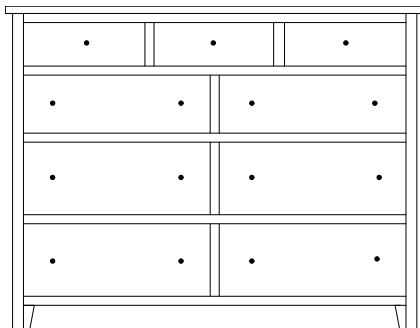

OD-2757 59" Dresser
57 $\frac{3}{4}$ "w 44 $\frac{1}{2}$ "h 21 $\frac{1}{2}$ "d
w/9 drawers

Suggested Mirrors:

MI-2732 Mirror
32"h 42"w

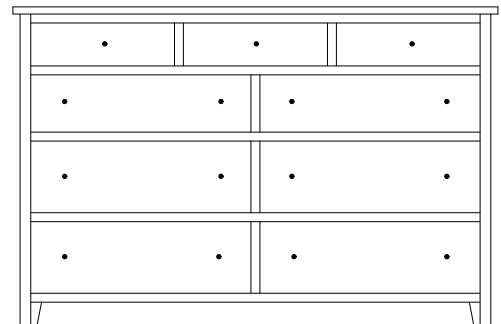

OD-2758 Tall Dresser
67 $\frac{3}{4}$ "w 44 $\frac{1}{2}$ "h 21 $\frac{1}{2}$ "d
w/9 drawers

Suggested Mirrors:

MI-2733 Mirror
32"h 52"w

Olde Cottage Mirrors



MI-2730 Mirror
40"h 36"w

MI-2731 Mirror
40"h 46"w

MI-2732 Mirror
32"h 42"w

MI-2733 Mirror
32"h 52"w

Beveled Mirror

Olde Cottage Bed Frames



shown with **Regular Footboard**

Olde Cottage Bed

Regular Footboard

Available
with underbed
storage options.

OD-2765-K (King)
81½"w 87½"l
HB 56"h ■ FB 17"h

OD-2765-Q (Queen)
66"w 87½"l
HB 56"h ■ FB 17"h

OD-2765-F (Full)
58¾"w 87½"l
HB 56"h ■ FB 17"h

OD-2765-T (Twin)
44"w 87½"l
HB 56"h ■ FB 17"h

Low Footboard

OD-2766-K (King)
81½"w 86"l
HB 56"h ■ FB 14¾"h

OD-2766-Q (Queen)
66"w 86"l
HB 56"h ■ FB 14¾"h

OD-2766-F (Full)
58¾"w 81"l
HB 56"h ■ FB 14¾"h

OD-2766-T (Twin)
44"w 81"l
HB 56"h ■ FB 14¾"h

Headboard Only

OD-2767K-HB (King)
56" high

OD-2767Q-HB (Queen)
56" high

OD-2767F-HB (Full)
56" high

OD-2767T-HB (Twin)
56" high

Olde Cottage Storage Rail Upgrades

12³/₄" From Floor to Box Spring

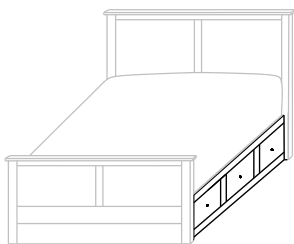

- With 3 drawers on each side
- 12³/₄" from floor to Box Spring
- Inside drawer dimensions on all sizes
9¹/₄"h 18⁷/₈"w 22¹/₂"d

532-SR-K King – 6 drawers
532-SR-Q Queen – 6 drawers
532-SR-F Full – 6 drawers
532-SR-T Twin – 3 drawers

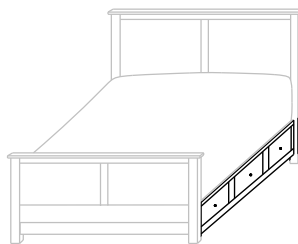

- With 3" Toe Kick
- With 3 drawers on each side
- 12³/₄" from floor to Box Spring
- Inside drawer dimensions on all sizes
6¹/₄"h 18⁷/₈"w 22¹/₂"d

234-SR-K King – 6 drawers
234-SR-Q Queen – 6 drawers
234-SR-F Full – 6 drawers
234-SR-T Twin – 3 drawers

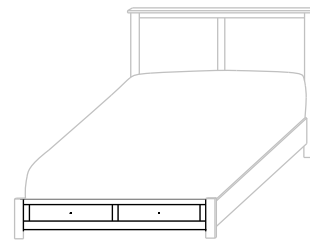

- 12³/₄" from floor to Box Spring
- Inside drawer dimensions
6¹/₄"h 22¹/₂"d
(King) 31" w (Queen) 23¹/₄" w
(Full) 19⁵/₈" w (Twin) 29¹/₄" w

685-FDS-K King – 2 drawers
685-FDS-Q Queen – 2 drawers
685-FDS-F Full – 2 drawers
685-FDS-T Twin – 1 drawer

19³/₄" From Floor to Box Spring

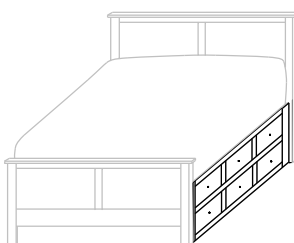

- With 6 drawers on each side
- Twin has 6 drawers on 1 side only
- 19³/₄" from floor to Box Spring
- Inside drawer dimensions on all sizes
6¹/₄"h 18⁷/₈"w 22¹/₂"d

654-SR-K King – 12 drawers
654-SR-Q Queen – 12 drawers
654-SR-F Full – 12 drawers
654-SR-T Twin – 6 drawers

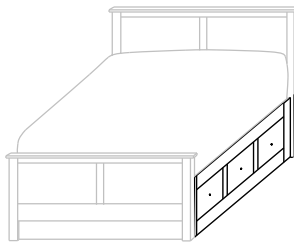

- With 3 drawers on each side
- 19³/₄" from floor to Box Spring
- Inside drawer dimensions on all sizes
10¹/₄"h 18⁷/₈"w 22¹/₂"d

325-SR-K King – 6 drawers
325-SR-Q Queen – 6 drawers
325-SR-F Full – 6 drawers
325-SR-T Twin – 3 drawers

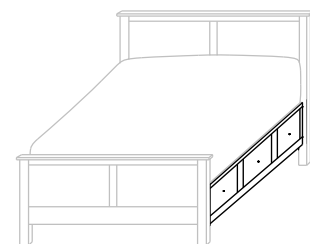

- With 7" Toe Kick
- With 3 drawers on each side
- 19³/₄" from floor to Box Spring
- Inside drawer dimensions on all sizes
9¹/₄"h 18⁷/₈"w 22¹/₂"d

236-SR-K King – 6 drawers
236-SR-Q Queen – 6 drawers
236-SR-F Full – 6 drawers
236-SR-T Twin – 3 drawers

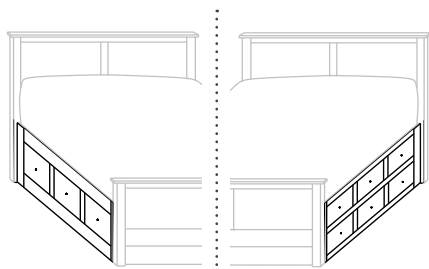

- With 3 drawers on one side and 6 drawers on other side
- 19³/₄" from floor to Box Spring

420-SR-K King – 9 drawers
420-SR-Q Queen – 9 drawers
420-SR-F Full – 9 drawers
 (Twin Not Available)

Additional Upgrades

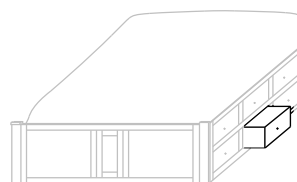

- With Step Stool Pullout in place of drawer

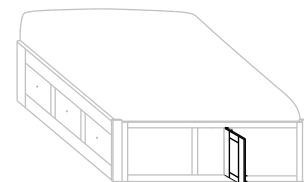

- With Door in Footboard to access area between rails





Regency
Bedroom Collection

Regency



Regency Bedroom Collection

- RG-2665Q Queen Bed w/ 532 Storage Upgrade
- RG-2642 Night Stand
- RG-2657 Dresser
- RG-2650 Chest
- RG-2635 Blanket Chest w/ Optional Leather Seat
- MI-2632 Mirror

Shown above in **Sap Cherry** with **New Carrington** with **4425-G10 Knobs** and **4424-G10 Pulls**

Standard Features:



4425-G10 Knobs & 4424-G10 Pulls



Standard with side-mount drawer slides



Stained poplar dovetailed drawers



Dovetailed bed slats

Available Upgrades:

- Any hardware on our Hardware Options Sheet
- Undermount soft close slides [See Price List]



- RG-2665Q Queen Bed
- RG-2642 Night Stand
- RG-2650 Chest
- RG-2657 Dresser
- MI-2632 Mirror

Shown in **Brown Maple** with **OCS-117 Asbury** and **4425-G10 Knob** and **4424-G10 Pulls**

Regency Night Stands



RG-2642
Night Stand shown

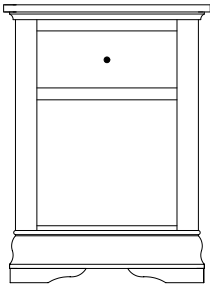

RG-2640 Night Stand
21 $\frac{3}{4}$ "w 29 $\frac{1}{4}$ "h 17 $\frac{3}{4}$ "d
w/1 drawer

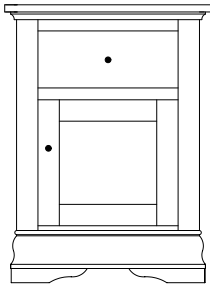

RG-2641 Night Stand
21 $\frac{3}{4}$ "w 29 $\frac{1}{4}$ "h 17 $\frac{3}{4}$ "d
w/1 drawer, 1 door

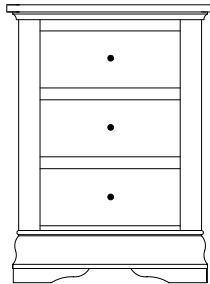

RG-2642 Night Stand
21 $\frac{3}{4}$ "w 29 $\frac{1}{4}$ "h 17 $\frac{3}{4}$ "d
w/3 drawers

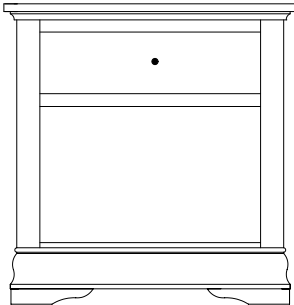

RG-2643 Night Stand
28 $\frac{1}{2}$ "w 29 $\frac{1}{4}$ "h 17 $\frac{3}{4}$ "d
w/1 drawer

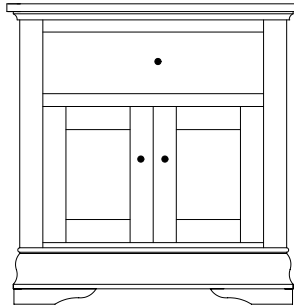

RG-2644 Night Stand
28 $\frac{1}{2}$ "w 29 $\frac{1}{4}$ "h 17 $\frac{3}{4}$ "d
w/1 drawer, 2 doors

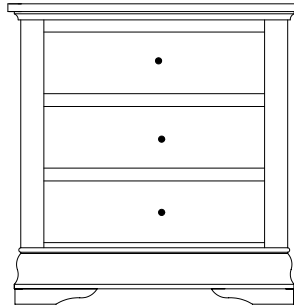

RG-2645 Night Stand
28 $\frac{1}{2}$ "w 29 $\frac{1}{4}$ "h 17 $\frac{3}{4}$ "d
w/3 drawers

Regency Lingeries & Chests



RG-2650
Chest shown

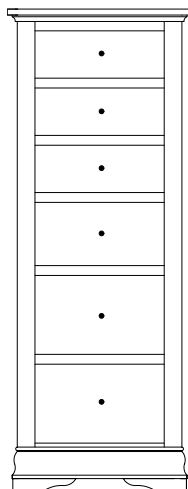

RG-2646 Lingerie
23 $\frac{3}{8}$ "w 61"h 21 $\frac{3}{4}$ "d
w/6 drawers

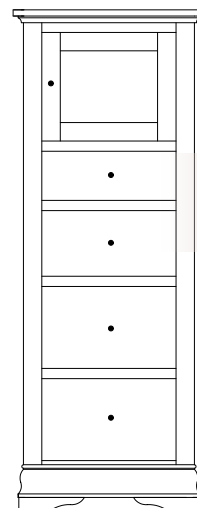

Available with
mirror in
door panel

RG-2647 Lingerie
23 $\frac{3}{8}$ "w 61"h 21 $\frac{3}{4}$ "d
w/4 drawers, 1 wood door,
1 adjustable shelf

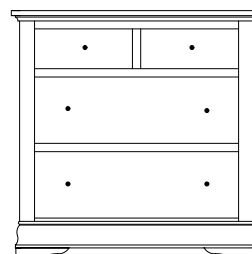

RG-2649 Chest
37 $\frac{3}{4}$ "w 37 $\frac{1}{4}$ "h 21 $\frac{3}{4}$ "d
w/4 drawers

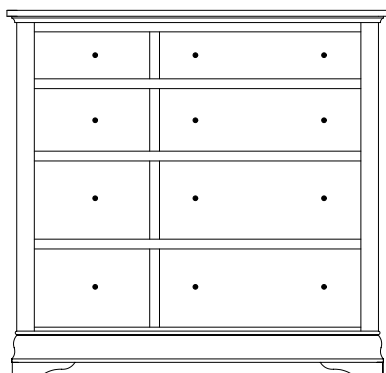

RG-2648 Chest
48 $\frac{3}{4}$ "w 46 $\frac{1}{2}$ "h 21 $\frac{3}{4}$ "d
w/8 drawers

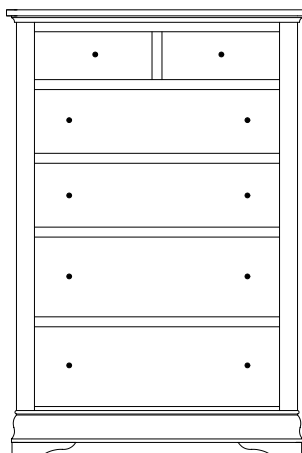

RG-2650 Chest
37 $\frac{3}{4}$ "w 55 $\frac{3}{4}$ "h 21 $\frac{3}{4}$ "d
w/6 drawers

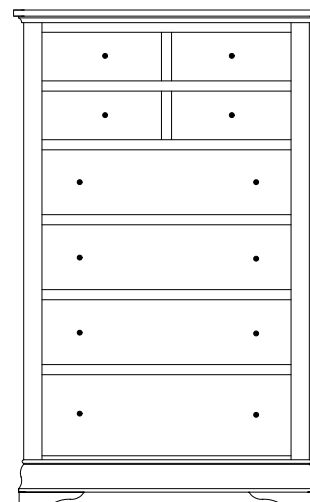

RG-2651 Hi-Boy
37 $\frac{3}{4}$ "w 61"h 21 $\frac{3}{4}$ "d
w/8 drawers

Regency Miscellaneous

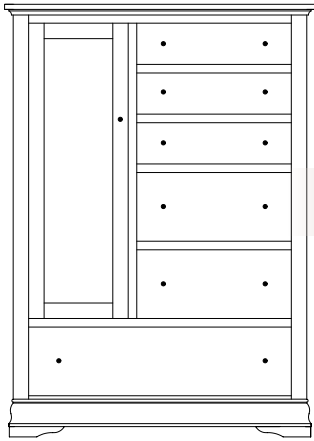

Option:
Mirror on
back of door

RG-2652 Chifferobe
45¼"w 63"h 21¾"d
w/6 drawers, 1 door, 2 adj. shelves

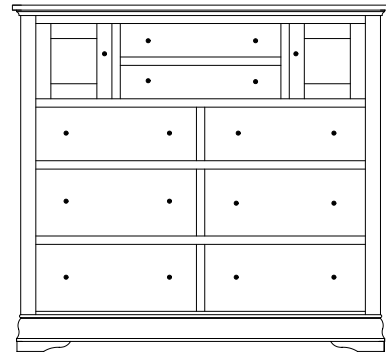

RG-2653 His & Hers Chest
56¼"w 51¾"h 21¾"d
w/8 drawers, 2 doors

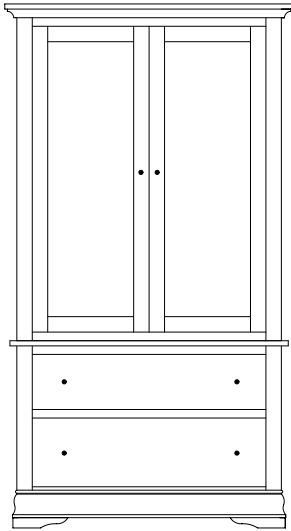

RG-2662 Armoire
42"w 76¼"h 22¼"d
w/2 drawers, w/2 doors,
2 adj. shelves & closet rod

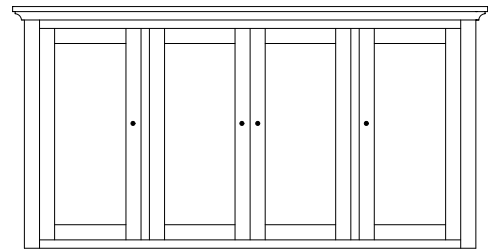

RG-2659 Mule Chest Top
70¾"w 36"h 22¼"d
w/4 doors & 6 adjustable shelves

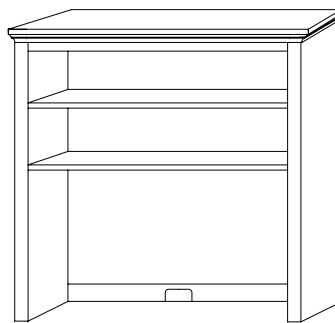

RG-2697 Study Carrel
49"w 42"h 13¾"d
w/2 adjustable shelves

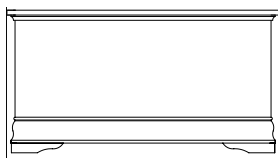

RG-2635 Blanket Chest
42"w 22"h 21½"d

- Available
with aromatic
cedar bottom
- Fabric or
Leather Seat

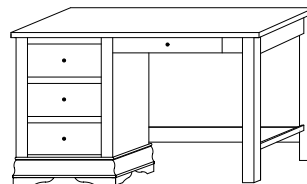

RG-2699 Student Desk
48"w 30"h 23"d
w/3 drawers
w/1 pencil drawer

Upgrades available on student desk:

Keyboard slideout instead of pencil drawer
File drawer instead of bottom 2 drawers

Regency Dressers



RG-2657 Dresser shown with MI-2632 Mirror

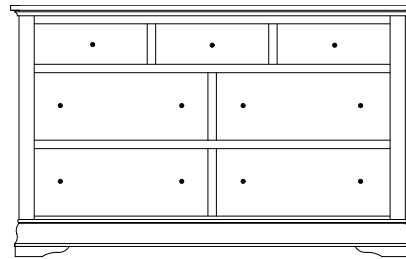

RG-2654 Dresser
59¾"w 37¼"h 21¾"d
w/7 drawers

Suggested Mirrors:

MI-2630 Mirror
40"h 36"w

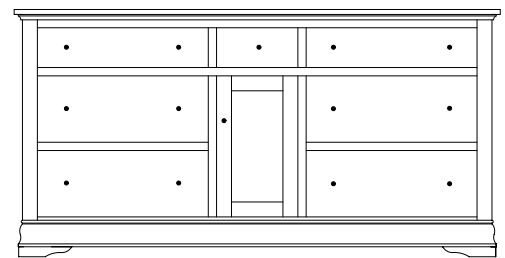

RG-2656 Dresser
73¼"w 37¼"h 21¾"d
w/7 drawers, 1 door
w/1 adjustable shelf

Suggested Mirrors:

MI-2631 Mirror
40"h 46"w

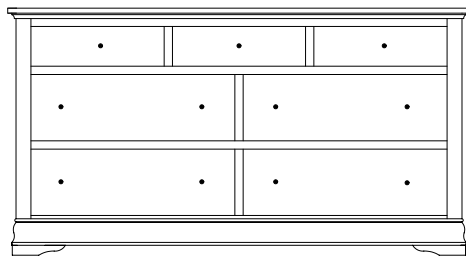

RG-2655 Dresser
69¾"w 37¼"h 21¾"d
w/7 drawers

Suggested Mirrors:

MI-2631 Mirror
40"h 46"w

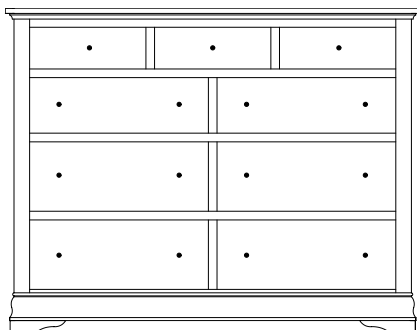

RG-2657 Dresser
59¾"w 46½"h 21¾"d
w/9 drawers

Suggested Mirrors:

MI-2632 Mirror
32"h 42"w

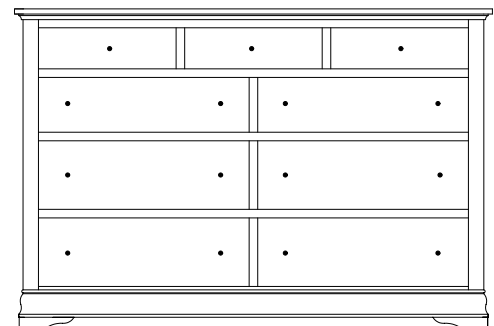

RG-2658 Dresser
69¾"w 46½"h 21¾"d
w/9 drawers

Suggested Mirrors:

MI-2633 Mirror
32"h 52"w

Regency Mirrors



MI-2630 Mirror
40"h 36"w

MI-2631 Mirror
40"h 46"w

MI-2632 Mirror
32"h 42"w

MI-2633 Mirror
32"h 52"w

Beveled Mirror

Regency Bed Frames



Bed shown with 532 Storage Upgrade and Regular Footboard

Regency Bed

Regular Footboard

Available with underbed storage options.

RG-2665-K (King)
79½"w 96½"l
HB 58"h ■ FB 38½"h

RG-2665-Q (Queen)
64½"w 96½"l
HB 58"h ■ FB 38½"h

RG-2665-F (Full)
57"w 91½"l
HB 58"h ■ FB 38½"h

RG-2665-T (Twin)
42½"w 91½"l
HB 58"h ■ FB 38½"h

Low Footboard

RG-2666-K (King)
79½"w 90¾"l
HB 58"h ■ FB 14¾"h

RG-2666-Q (Queen)
64½"w 90¾"l
HB 58"h ■ FB 14¾"h

RG-2666-F (Full)
57"w 85¾"l
HB 58"h ■ FB 14¾"h

RG-2666-T (Twin)
42½"w 85¾"l
HB 58"h ■ FB 14¾"h

Headboard Only

RG-2667K-HB (King)
58" high

RG-2667Q-HB (Queen)
58" high

RG-2667F-HB (Full)
58" high

RG-2667T-HB (Twin)
58" high

Regency Storage Rail Upgrades

12³/₄" From Floor to Box Spring

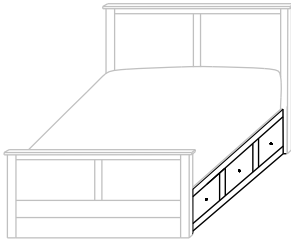

- With 3 drawers on each side
- 12³/₄" from floor to Box Spring
- Inside drawer dimensions on all sizes
9¹/₄"h 18⁷/₈"w 22¹/₂"d

532-SR-K King – 6 drawers
532-SR-Q Queen – 6 drawers
532-SR-F Full – 6 drawers
532-SR-T Twin – 3 drawers

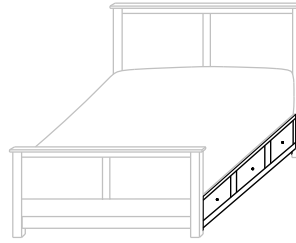

- With 3" Toe Kick
- With 3 drawers on each side
- 12³/₄" from floor to Box Spring
- Inside drawer dimensions on all sizes
6¹/₄"h 18⁷/₈"w 22¹/₂"d

234-SR-K King – 6 drawers
234-SR-Q Queen – 6 drawers
234-SR-F Full – 6 drawers
234-SR-T Twin – 3 drawers

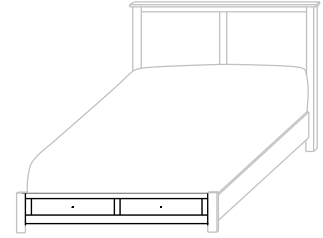

- 12³/₄" from floor to Box Spring
- Inside drawer dimensions
6¹/₄"h 22¹/₂"d
(King) 31" w (Queen) 23¹/₄" w
(Full) 19⁵/₈" w (Twin) 29¹/₄" w

685-FDS-K King – 2 drawers
685-FDS-Q Queen – 2 drawers
685-FDS-F Full – 2 drawers
685-FDS-T Twin – 1 drawer

19³/₄" From Floor to Box Spring

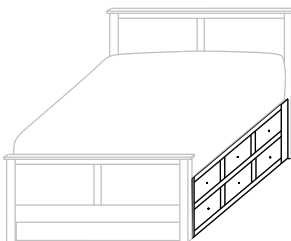

- With 6 drawers on each side
- Twin has 6 drawers on 1 side only
- 19³/₄" from floor to Box Spring
- Inside drawer dimensions on all sizes
6¹/₄"h 18⁷/₈"w 22¹/₂"d

654-SR-K King – 12 drawers
654-SR-Q Queen – 12 drawers
654-SR-F Full – 12 drawers
654-SR-T Twin – 6 drawers

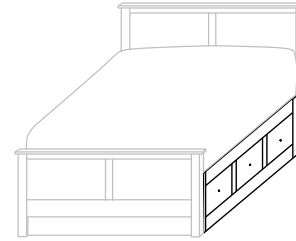

- With 3 drawers on each side
- 19³/₄" from floor to Box Spring
- Inside drawer dimensions on all sizes
10¹/₄"h 18⁷/₈"w 22¹/₂"d

325-SR-K King – 6 drawers
325-SR-Q Queen – 6 drawers
325-SR-F Full – 6 drawers
325-SR-T Twin – 3 drawers

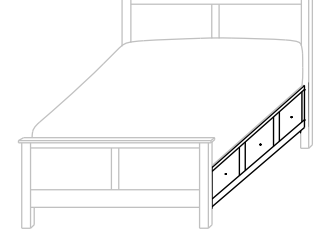

- With 7" Toe Kick
- With 3 drawers on each side
- 19³/₄" from floor to Box Spring
- Inside drawer dimensions on all sizes
9¹/₄"h 18⁷/₈"w 22¹/₂"d

236-SR-K King – 6 drawers
236-SR-Q Queen – 6 drawers
236-SR-F Full – 6 drawers
236-SR-T Twin – 3 drawers

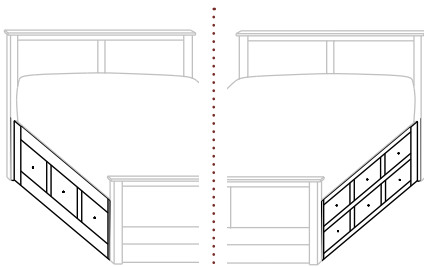

- With 3 drawers on one side and 6 drawers on other side
- 19³/₄" from floor to Box Spring

420-SR-K King – 9 drawers
420-SR-Q Queen – 9 drawers
420-SR-F Full – 9 drawers
 (Twin Not Available)

Additional Upgrades

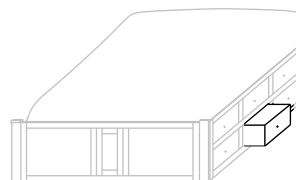

- With Step Stool Pullout in place of drawer

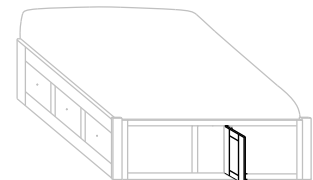

- With Door in Footboard to access area between rails





Rosedale
Bedroom Collection

Rosedale



Rosedale Bedroom Collection

- RD-3165Q Queen Bed w/234 Storage Upgrade
- RD-3142 Night Stand
- RD-3150 Chest
- RD-3157 Dresser
- MI-3132 Mirror

Shown above in **Sap Cherry** with **OCS-117 Asbury** with **4424-G10 Pulls**

Standard Features:



4424-G10 Pulls



Standard with side-mount drawer slides



Stained poplar dovetailed drawers



Dovetailed bed slats

Available Upgrades:

- Any hardware on our Hardware Options Sheet
- Undermount soft close slides [See Price List]



- RD-3165Q Queen Bed
- RD-3142 Night Stand
- RD-3150 Chest
- RD-3157 Dresser
- MI-3132 Mirror

Shown in **Sap Cherry** with **FC-42000 Almond** and **4424-ORB Pulls**

Rosedale Night Stands



RD-3142
Night Stand shown

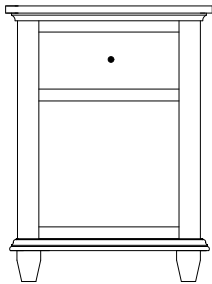

RD-3140 Night Stand
21 $\frac{3}{4}$ "w 29"h 17 $\frac{3}{4}$ "d
w/1 drawer

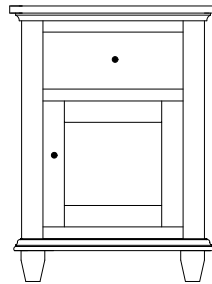

RD-3141 Night Stand
21 $\frac{3}{4}$ "w 29"h 17 $\frac{3}{4}$ "d
w/1 drawer & 1 door

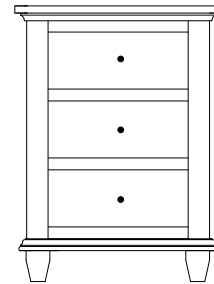

RD-3142 Night Stand
21 $\frac{3}{4}$ "w 29"h 17 $\frac{3}{4}$ "d
w/3 drawers

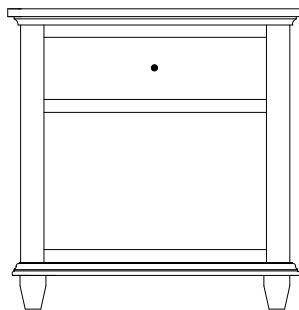

RD-3143 Night Stand
28 $\frac{1}{2}$ "w 29"h 17 $\frac{3}{4}$ "d
w/1 drawer

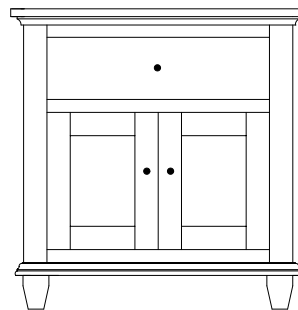

RD-3144 Night Stand
28 $\frac{1}{2}$ "w 29"h 17 $\frac{3}{4}$ "d
w/1 drawer, 2 doors



RD-3145 Night Stand
28 $\frac{1}{2}$ "w 29"h 17 $\frac{3}{4}$ "d
w/3 drawers

Rosedale Lingeries & Chests



RD-3150
Chest shown

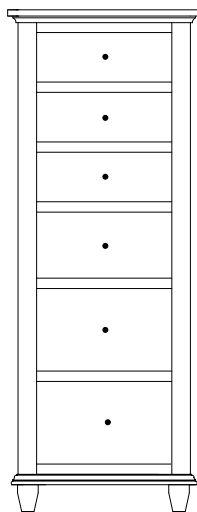

RD-3146 Lingerie
23 $\frac{3}{8}$ "w 60 $\frac{3}{4}$ "h 21 $\frac{3}{4}$ "d
w/6 drawers

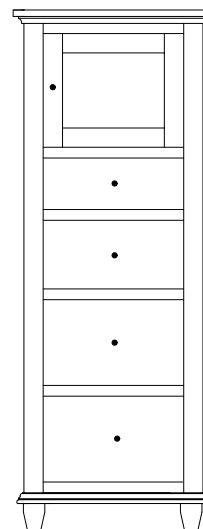

RD-3147 Lingerie
23 $\frac{3}{8}$ "w 60 $\frac{3}{4}$ "h 21 $\frac{3}{4}$ "d
w/4 drawers, 1 wood door,
1 adjustable shelf



RD-3149 Chest
37 $\frac{3}{4}$ "w 37"h 21 $\frac{3}{4}$ "d
w/4 drawers

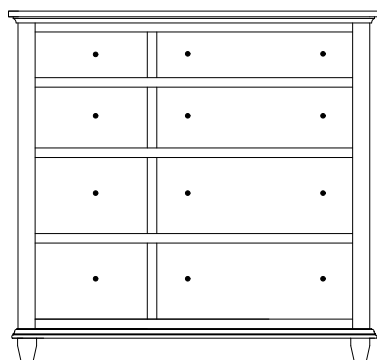

RD-3148 Chest
48 $\frac{3}{4}$ "w 46 $\frac{1}{4}$ "h 21 $\frac{3}{4}$ "d
w/8 drawers

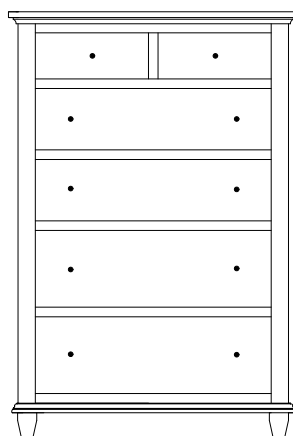

RD-3150 Chest
37 $\frac{3}{4}$ "w 55 $\frac{1}{2}$ "h 21 $\frac{3}{4}$ "d
w/6 drawers

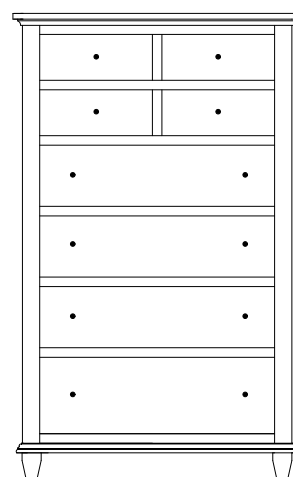

RD-3151 Hi-Boy
37 $\frac{3}{4}$ "w 60 $\frac{3}{4}$ "h 21 $\frac{3}{4}$ "d
w/8 drawers

Rosedale Miscellaneous

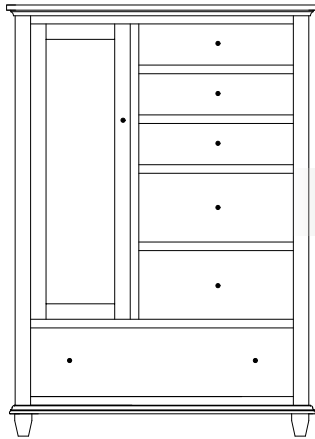

Option:
Mirror on
back of door

RD-3152 Chifferobe
45¼"w 62¾"h 21¾"d
w/6 drawers, 1 door, 2 adj. shelves

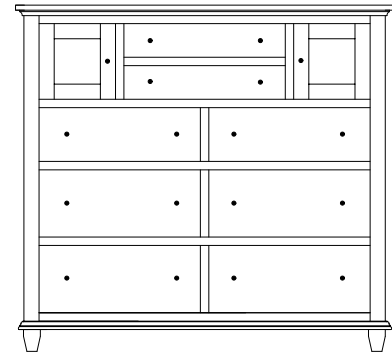

RD-3153 His & Hers Chest
56¼"w 51½"h 21¾"d
w/8 drawers, 2 doors

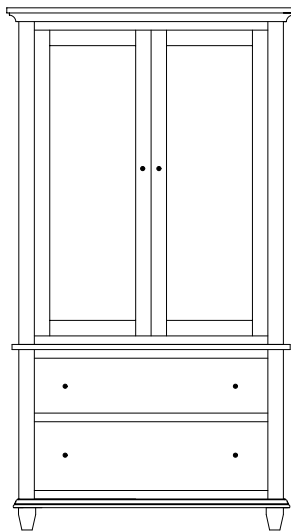

RD-3162 Armoire
42"w 76¼"h 22¼"d
w/2 drawers, w/2 doors,
2 adj. shelves & closet rod

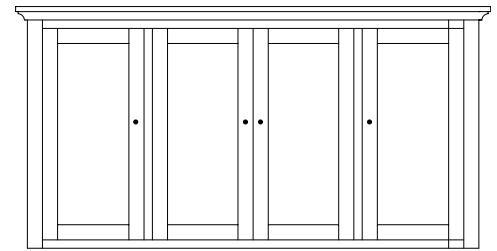

RD-3159 Mule Chest Top
70¾"w 36"h 22¼"d
w/4 doors & 6 adjustable shelves

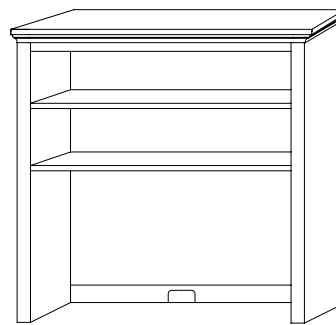

RD-3197 Study Carrel
49½"w 42"h 13¾"d
w/2 adjustable shelves

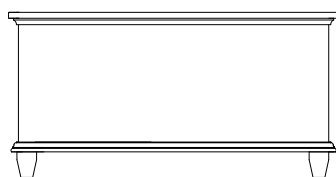

RD-3135 Blanket Chest
42"w 22"h 21½"d

Available
with aromatic
cedar bottom

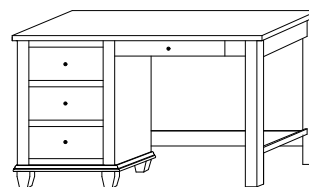

RD-3199 Student Desk
48"w 29¾"h 23"d
w/3 drawers
w/1 pencil drawer

Upgrades available on student desk:

Keyboard slideout instead of pencil drawer
File drawer instead of bottom 2 drawers

Rosedale Dressers



RD-3157 Dresser shown with MI-2370 Mirror

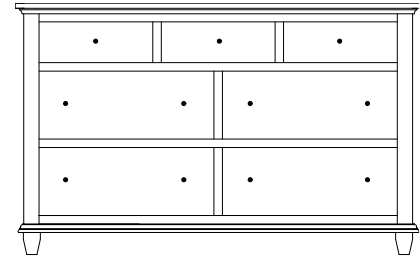

RD-3154 Dresser
58 $\frac{3}{4}$ "w 35 $\frac{3}{4}$ "h 21 $\frac{1}{2}$ "d
w/7 drawers

Suggested Mirrors:

MI-3130 Mirror
40"h 36"w

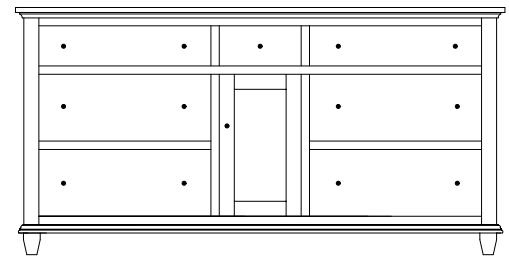

RD-3156 Dresser
72 $\frac{1}{4}$ "w 35 $\frac{3}{4}$ "h 21 $\frac{1}{2}$ "d
w/7 drawers, 1 door
w/1 adjustable shelf

Suggested Mirrors:

MI-3131 Mirror
40"h 46"w

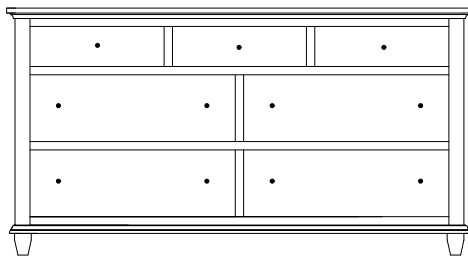

RD-3155 Dresser
68 $\frac{3}{4}$ "w 35 $\frac{3}{4}$ "h 21 $\frac{1}{2}$ "d
w/7 drawers

Suggested Mirrors:

MI-3131 Mirror
40"h 46"w

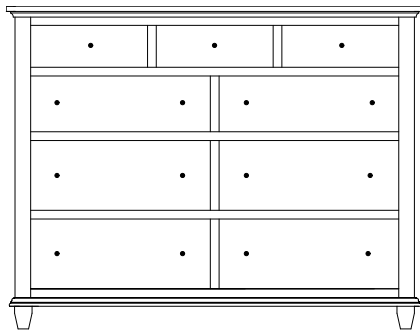

RD-3157 Dresser
58 $\frac{3}{4}$ "w 45"h 21 $\frac{1}{2}$ "d
w/9 drawers

Suggested Mirrors:

MI-3132 Mirror
32"h 42"w

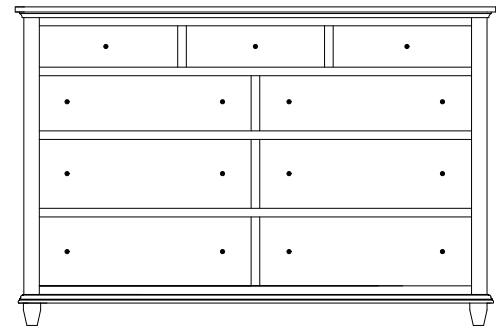

RD-3158 Dresser
68 $\frac{3}{4}$ "w 45"h 21 $\frac{1}{2}$ "d
w/9 drawers

Suggested Mirrors:

MI-3133 Mirror
32"h 52"w

Rosedale Mirrors



MI-3130 Mirror
40"h 36"w

MI-3131 Mirror
40"h 46"w

MI-3132 Mirror
32"h 42"w

MI-3133 Mirror
32"h 52"w

Beveled Mirror

Rosedale Bed Frames



Shown with and **Regular Footboard**

Rosedale Bed

Regular Footboard

Available
with underbed
storage options.

RD-3165-K (King)
82½"w 87"l
HB 58"h ■ FB 18"h

RD-3165-Q (Queen)
66½"w 87"l
HB 58"h ■ FB 18"h

RD-3165-F (Full)
59¾"w 82"l
HB 58"h ■ FB 18"h

RD-3165-T (Twin)
44½"w 82"l
HB 58"h ■ FB 18"h

Low Footboard

RD-3166-K (King)
82½"w 85¼"l
HB 58"h ■ FB 14¾"h

RD-3166-Q (Queen)
66½"w 85¼"l
HB 58"h ■ FB 14¾"h

RD-3166-F (Full)
59¾"w 80¼"l
HB 58"h ■ FB 14¾"h

RD-3166-T (Twin)
44½"w 80¼"l
HB 58"h ■ FB 14¾"h

Headboard Only

RD-3167K-HB (King)
58" high

RD-3167Q-HB (Queen)
58" high

RD-3167F-HB (Full)
58" high

RD-3167T-HB (Twin)
58" high

Rosedale Storage Rail Upgrades

12³/₄" From Floor to Box Spring

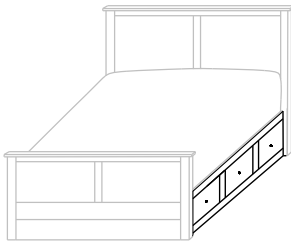

- With 3 drawers on each side
- 12³/₄" from floor to Box Spring
- Inside drawer dimensions on all sizes
9¹/₄"h 18⁷/₈"w 22¹/₂"d

532-SR-K King – 6 drawers
532-SR-Q Queen – 6 drawers
532-SR-F Full – 6 drawers
532-SR-T Twin – 3 drawers

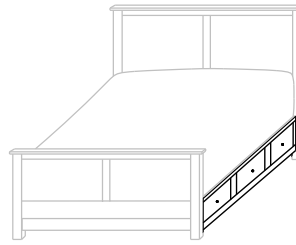

- With 3" Toe Kick
- With 3 drawers on each side
- 12³/₄" from floor to Box Spring
- Inside drawer dimensions on all sizes
6¹/₄"h 18⁷/₈"w 22¹/₂"d

234-SR-K King – 6 drawers
234-SR-Q Queen – 6 drawers
234-SR-F Full – 6 drawers
234-SR-T Twin – 3 drawers

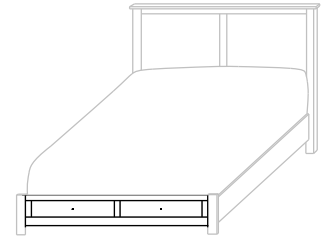

- 12³/₄" from floor to Box Spring
- Inside drawer dimensions
6¹/₄"h 22¹/₂"d
(King) 31" w (Queen) 23¹/₄" w
(Full) 19⁵/₈" w (Twin) 29¹/₄" w

685-FDS-K King – 2 drawers
685-FDS-Q Queen – 2 drawers
685-FDS-F Full – 2 drawers
685-FDS-T Twin – 1 drawer

19³/₄" From Floor to Box Spring

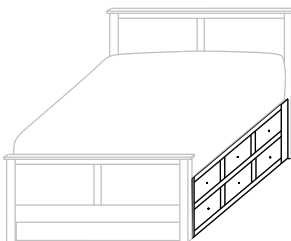

- With 6 drawers on each side
- Twin has 6 drawers on 1 side only
- 19³/₄" from floor to Box Spring
- Inside drawer dimensions on all sizes
6¹/₄"h 18⁷/₈"w 22¹/₂"d

654-SR-K King – 12 drawers
654-SR-Q Queen – 12 drawers
654-SR-F Full – 12 drawers
654-SR-T Twin – 6 drawers

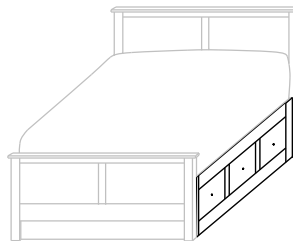

- With 3 drawers on each side
- 19³/₄" from floor to Box Spring
- Inside drawer dimensions on all sizes
10¹/₄"h 18⁷/₈"w 22¹/₂"d

325-SR-K King – 6 drawers
325-SR-Q Queen – 6 drawers
325-SR-F Full – 6 drawers
325-SR-T Twin – 3 drawers

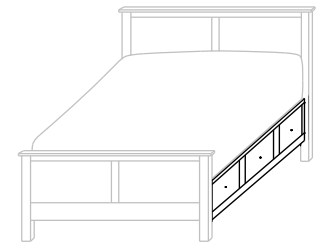

- With 7" Toe Kick
- With 3 drawers on each side
- 19³/₄" from floor to Box Spring
- Inside drawer dimensions on all sizes
9¹/₄"h 18⁷/₈"w 22¹/₂"d

236-SR-K King – 6 drawers
236-SR-Q Queen – 6 drawers
236-SR-F Full – 6 drawers
236-SR-T Twin – 3 drawers

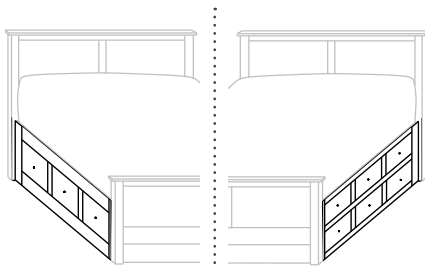

- With 3 drawers on one side and 6 drawers on other side
- 19³/₄" from floor to Box Spring

420-SR-K King – 9 drawers
420-SR-Q Queen – 9 drawers
420-SR-F Full – 9 drawers
 (Twin Not Available)

Additional Upgrades

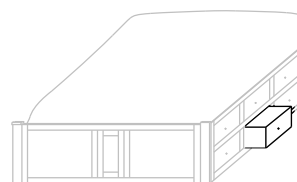

- With Step Stool Pullout in place of drawer

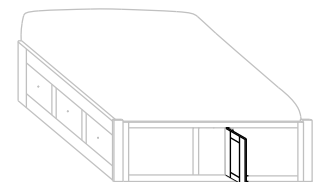

- With Door in Footboard to access area between rails





Shoreview
Bedroom Collection

Shoreview



Shoreview Bedroom Collection w/Shoreview Bed

- SH-2090Q Queen Bed
- SH-2011 Night Stand
- SH-2026 Chest
- SH-2030 Dresser
- MI-2430 Mirror

Shown above in **Brown Maple** with **OCS-113 Michael** and **K800-SN Knobs**

Standard Features:



K800-SN Knobs



Standard with side-mount drawer slides

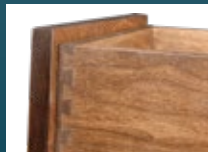

Stained poplar drawer boxes



Dovetailed bed slats



- SH-2090Q Shoreview Bed
- SH-2011 Night Stand
- SH-2026 Chest
- SH-2030 Dresser
- MI-2430 Mirror

*Shown in Brown Maple
FC-47872 Bel-Aire and
K800-SN Hardware*

Available Upgrades:

- Any hardware on our Hardware Options Sheet
- Undermount soft close slides [See Price List]

Shoreview Night Stands



SH-2016
Night Stand shown



Sliding top option available on all night stands
(Hidden compartment w/Lock)

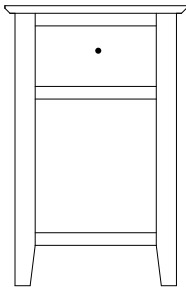

SH-2011 Night Stand
18"w 27¾"h 18"d
w/1 drawer

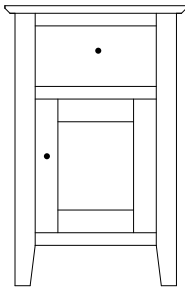

SH-2012 Night Stand
18"w 27¾"h 18"d
w/1 drawer, 1 door

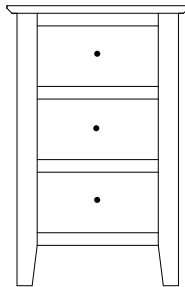

SH-2013 Night Stand
18"w 27¾"h 18"d
w/3 drawers

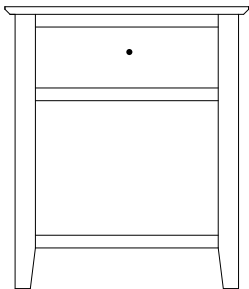

SH-2014 Night Stand
24"w 27¾"h 18"d
w/1 drawer

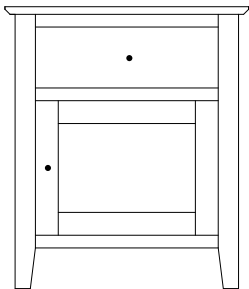

SH-2015 Night Stand
24"w 27¾"h 18"d
w/1 drawer, 1 door

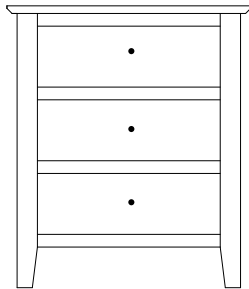

SH-2016 Night Stand
24"w 27¾"h 18"d
w/3 drawers

Shoreview Lingeries & Chests



SH-2026
Chest shown

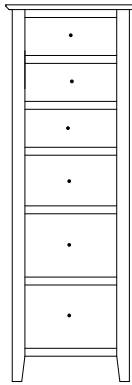

SH-2017 Lingerie
20½"w 59½"h 19½"d
w/6 drawers

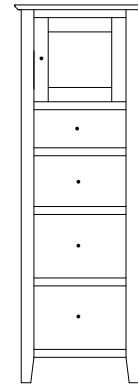

Available with
mirror in
door panel

SH-2018 Lingerie
20½"w 59½"h 19½"d
w/4 drawers, 1 wood door,
1 adjustable shelf

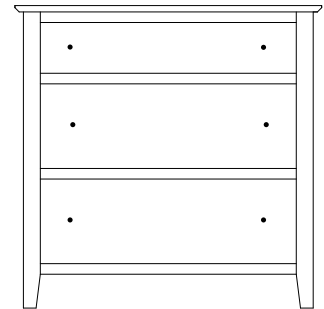

SH-2049 Chest
36¼"w 35¾"h 19½"d
w/3 drawers

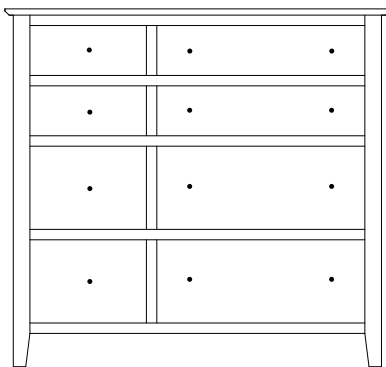

SH-2041 Chest
46¼"w 43"h 19½"d
w/8 drawers

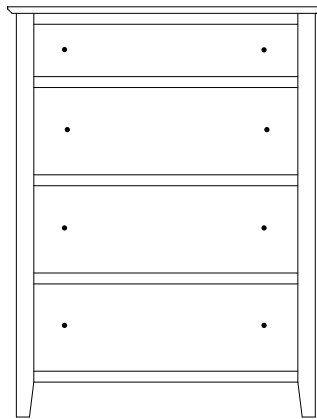

SH-2026 Chest
36¼"w 47"h 19½"d
w/4 drawers

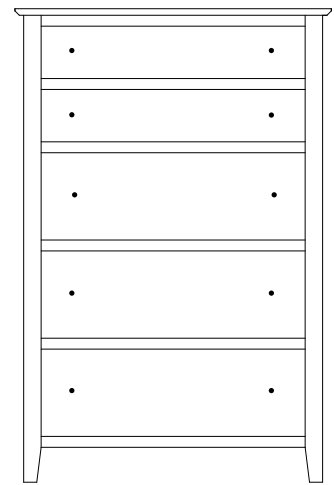

SH-2027 Hi-Boy
36¼"w 54¼"h 19½"d
w/5 drawers

Shoreview Miscellaneous

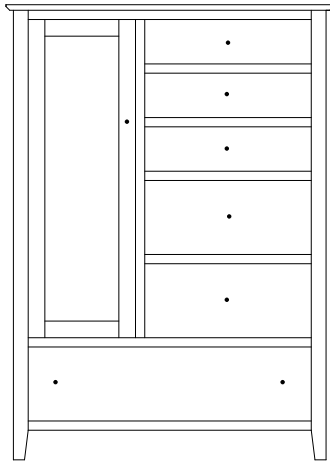

Option:
Mirror on
back of door

SH-2028 Chifferobe
44 1/4"w 61 1/2"h 19 1/2"d
w/6 drawers, 1 door, 2 adj. shelves

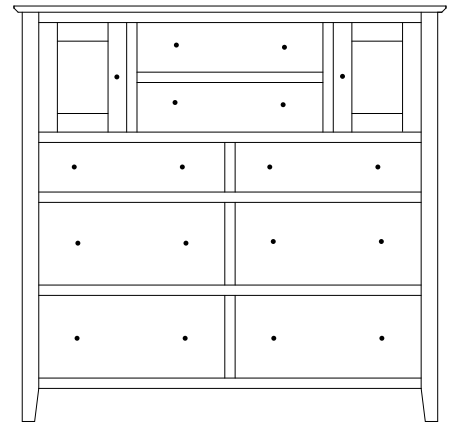

SH-2047 His & Hers
52 1/2"w 50 1/4"h 19 1/2"d
w/8 drawers, 2 doors

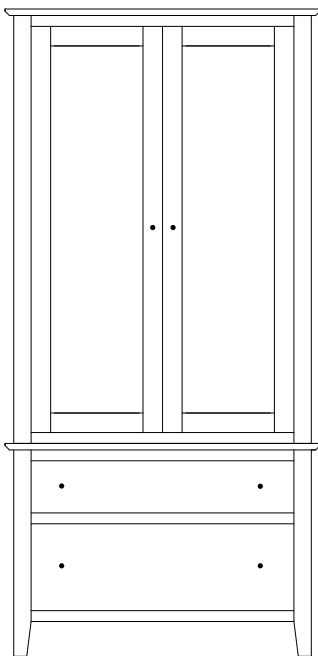

SH-2062 Armoire
36 1/4"w 78"h 19 1/2"d
w/2 drawers, w/2 doors
2 adj. shelves & closet rod

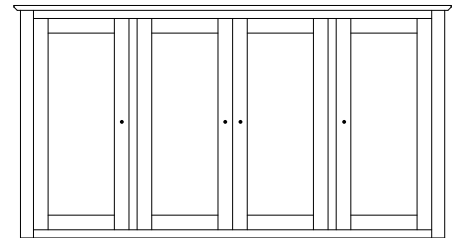

SH-2059 Mule Chest Top
67 3/4"w 35"h 19 1/2"d
w/4 doors & 6 adjustable shelves

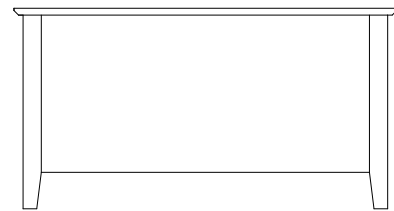

SH-2035 Blanket Chest
42"w 22"h 19 1/2"d

Available
with aromatic
cedar bottom

Shoreview Dressers



SH-2030 Dresser shown with MI-2430 Mirror

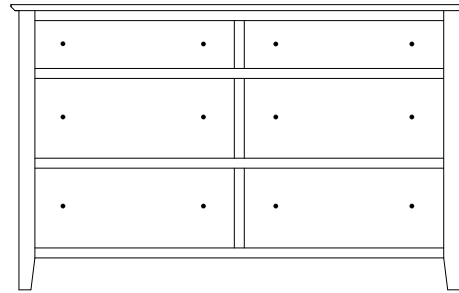

SH-2030 Dresser
57 1/4"w 35 3/4"h 19 1/2"d
w/6 drawers

Suggested Mirrors:

MI-2430 Mirror
40"h 36"w

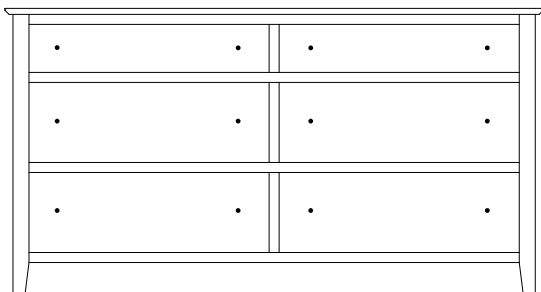

SH-2031 Dresser
67 3/4"w 35 3/4"h 19 1/2"d
w/6 drawers

Suggested Mirrors:

MI-2431 Mirror
40"h 46"w

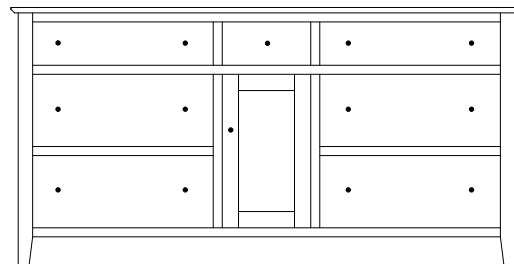

SH-2032 Dresser
70 3/4"w 35 3/4"h 19 1/2"d
w/7 drawers, 1 door
w/1 adjustable shelf

Suggested Mirrors:

MI-2431 Mirror
40"h 46"w

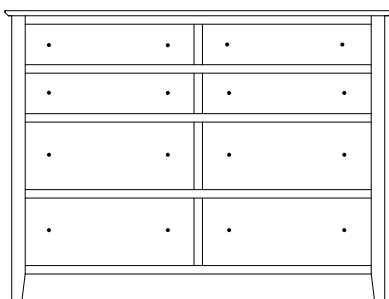

SH-2043 Tall Dresser
57 1/4"w 43"h 19 1/2"d
w/8 drawers

Suggested Mirrors:

MI-2432 Mirror
32"h 42"w

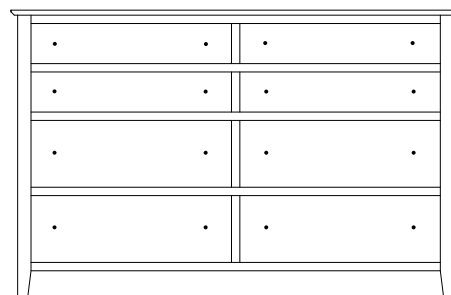

SH-2044 Tall Dresser
67 3/4"w 43"h 19 1/2"d
w/8 drawers

Suggested Mirrors:

MI-2433 Mirror
32"h 52"w

Shoreview Mirrors



Plain Mirror

MI-2430 Mirror
40"high 36"wide

MI-2431 Mirror
40"high 46"wide

MI-2432 Mirror
32"high 42"wide

MI-2433 Mirror
32"high 52"wide

Shoreview Bed Frames



shown with Regular Footboard

Shoreview Beds

Available
with underbed
storage options.

Regular Footboard

SH-2088-K (King)
81½"w 85½"l
HB 48"h ■ FB 30"h

SH-2088-Q (Queen)
66"w 85½"l
HB 48"h ■ FB 30"h

SH-2088-F (Full)
58¾"w 80½"l
HB 48"h ■ FB 30"h

SH-2088-T (Twin)
44"w 80½"l
HB 48"h ■ FB 30"h

Low Footboard

SH-2090-K (King)
81½"w 84½"l
HB 48"h ■ FB 14¾"h

SH-2090-Q (Queen)
66"w 84½"l
HB 48"h ■ FB 14¾"h

SH-2090-F (Full)
58¾"w 79½"l
HB 48"h ■ FB 14¾"h

SH-2090-T (Twin)
44"w 79½"l
HB 48"h ■ FB 14¾"h

Headboard Only

SH-2098-HB-K (King)
48" high

SH-2098-HB-Q (Queen)
48" high

SH-2098-HB-F (Full)
48" high

SH-2098-HB-T (Twin)
48" high

Shoreview Storage Rail Upgrades

12³/₄" From Floor to Box Spring

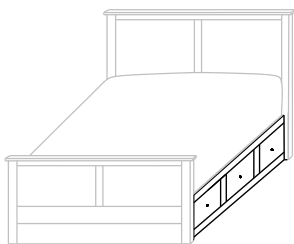

- With 3 drawers on each side
- 12³/₄" from floor to Box Spring
- Inside drawer dimensions on all sizes
9¹/₄"h 18⁷/₈"w 22¹/₂"d

532-SR-K King – 6 drawers
532-SR-Q Queen – 6 drawers
532-SR-F Full – 6 drawers
532-SR-T Twin – 3 drawers

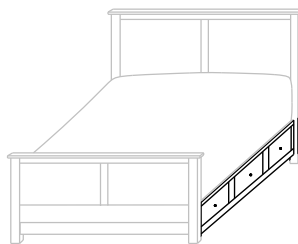

- With 3" Toe Kick
- With 3 drawers on each side
- 12³/₄" from floor to Box Spring
- Inside drawer dimensions on all sizes
6¹/₄"h 18⁷/₈"w 22¹/₂"d

234-SR-K King – 6 drawers
234-SR-Q Queen – 6 drawers
234-SR-F Full – 6 drawers
234-SR-T Twin – 3 drawers

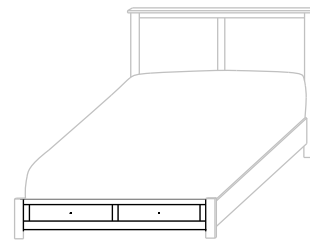

- 12³/₄" from floor to Box Spring
- Inside drawer dimensions
6¹/₄"h 22¹/₂"d
 (King) 31" w (Queen) 23¹/₄" w
 (Full) 19⁵/₈" w (Twin) 29¹/₄" w

685-FDS-K King – 2 drawers
685-FDS-Q Queen – 2 drawers
685-FDS-F Full – 2 drawers
685-FDS-T Twin – 1 drawer

19³/₄" From Floor to Box Spring

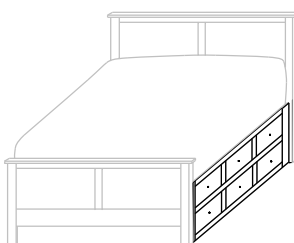

- With 6 drawers on each side
- Twin has 6 drawers on 1 side only
- 19³/₄" from floor to Box Spring
- Inside drawer dimensions on all sizes
6¹/₄"h 18⁷/₈"w 22¹/₂"d

654-SR-K King – 12 drawers
654-SR-Q Queen – 12 drawers
654-SR-F Full – 12 drawers
654-SR-T Twin – 6 drawers

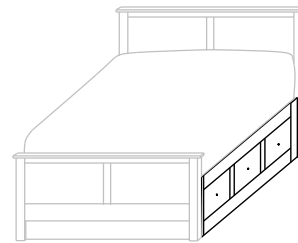

- With 3 drawers on each side
- 19³/₄" from floor to Box Spring
- Inside drawer dimensions on all sizes
10¹/₄"h 18⁷/₈"w 22¹/₂"d

325-SR-K King – 6 drawers
325-SR-Q Queen – 6 drawers
325-SR-F Full – 6 drawers
325-SR-T Twin – 3 drawers

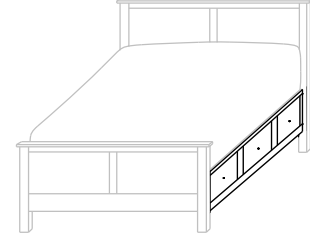

- With 7" Toe Kick
- With 3 drawers on each side
- 19³/₄" from floor to Box Spring
- Inside drawer dimensions on all sizes
9¹/₄"h 18⁷/₈"w 22¹/₂"d

236-SR-K King – 6 drawers
236-SR-Q Queen – 6 drawers
236-SR-F Full – 6 drawers
236-SR-T Twin – 3 drawers

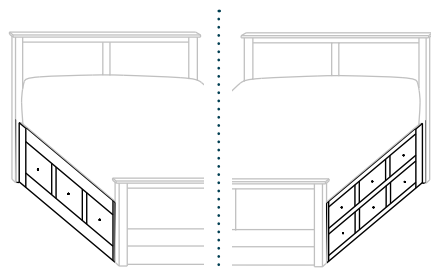

- With 3 drawers on one side and 6 drawers on other side
- 19³/₄" from floor to Box Spring

420-SR-K King – 9 drawers
420-SR-Q Queen – 9 drawers
420-SR-F Full – 9 drawers
 (Twin Not Available)

Additional Upgrades

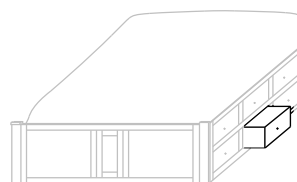

- With Step Stool Pullout in place of drawer

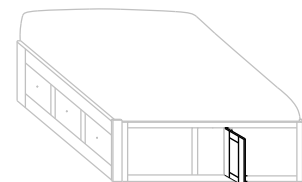

- With Door in Footboard to access area between rails





MAKE YOURSELF
COMFORTABLE



Sonora
Bedroom Collection

Sonora



Sonora Bedroom Collection w/Sleepwell Bed

- SW-493Q Queen Bed
- TB-61 Night Stand
- SO-162 Chest
- SO-163 Dresser
- MI-2130 Mirror

Shown above in **Brown Maple** with **OCS-117 Asbury** and **1½" Wood Knobs**

Standard Features:



1½" Wood Knobs



Standard with side-mount drawer slides

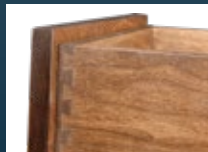

Stained poplar drawer boxes



Dovetailed bed slats



- SO-1050Q Panel Bed
- SO-116 Night Stand
- SO-162 Chest
- SO-144 Tall Dresser
- MI-2133 Mirror

Shown in *Rustic Cherry* with **OCS-117 Asbury** and **44-4281-191 Hardware**

Available Upgrades:

- Any hardware on our Hardware Options Sheet
- Undermount soft close slides [See Price List]

Sonora Night Stands



SO-116
Night Stand shown



Sliding top option available on all night stands
(Hidden compartment w/Lock)

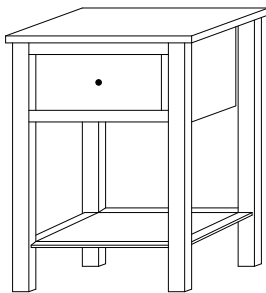

TB-61 Night Stand
20¼"w 27½"h 19¼"d
w/1 drawer

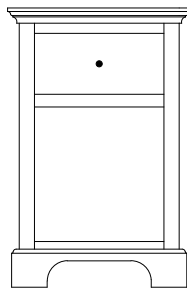

SO-111 Night Stand
18"w 27½"h 19"d
w/1 drawer

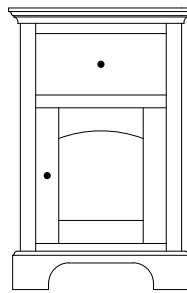

SO-112 Night Stand
18"w 27½"h 19"d
w/1 drawer, 1 door

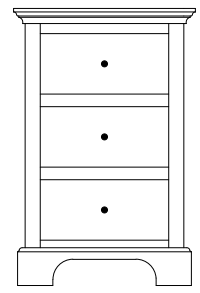

SO-113 Night Stand
18"w 27½"h 19"d
w/3 drawers

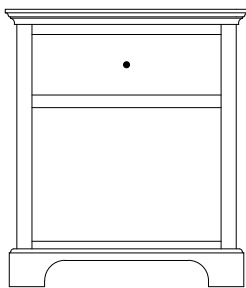

SO-114 Night Stand
24"w 27½"h 19"d
w/1 drawer

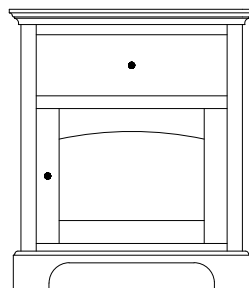

SO-115 Night Stand
24"w 27½"h 19"d
w/1 drawer, 1 door

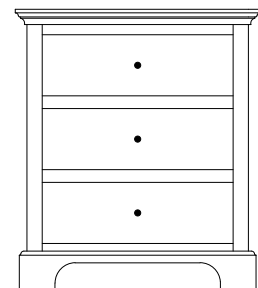

SO-116 Night Stand
24"w 27½"h 19"d
w/3 drawers

Sonora Lingeries & Chests



SO-162
Chest shown

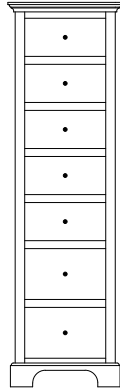

SO-117 Lingerie
18"w 60½"h 21"d
w/7 drawers

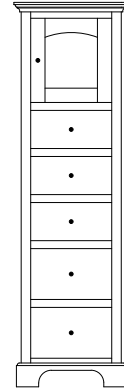

Available with
mirror panel
in door (SO-119)

SO-118 Lingerie
18"w 60½"h 21"d
w/5 drawers, 1 wood door,
1 adjustable shelf

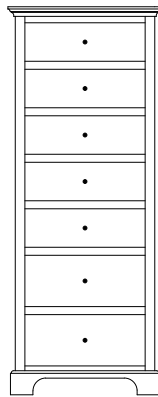

SO-120 Lingerie
24"w 60½"h 21"d
w/7 drawers

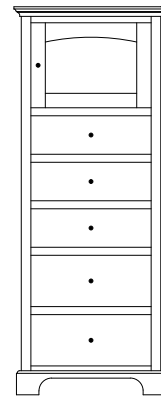

Available with
mirror panel
in door (SO-122)

SO-121 Lingerie
24"w 60½"h 21"d
w/5 drawers, 1 wood door,
1 adjustable shelf

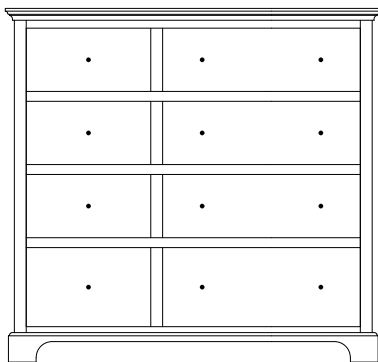

SO-141 Chest
48"w 44¾"h 21"d
w/8 drawers

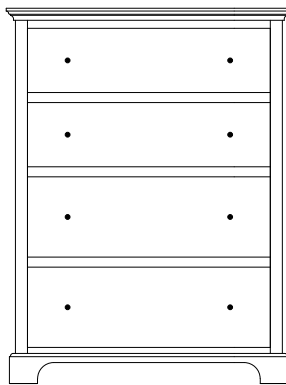

SO-126 Chest
36"w 46¾"h 21"d
w/4 drawers

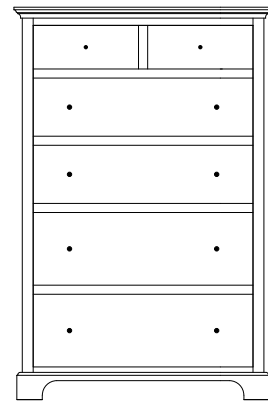

SO-162 Chest
36"w 54"h 21"d
w/6 drawers

Sonora Miscellaneous

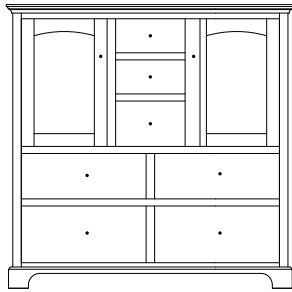

SO-147 His & Hers
51¼"w 50"h 21"d
w/7 drawers, 2 doors, 2 adj. shelves

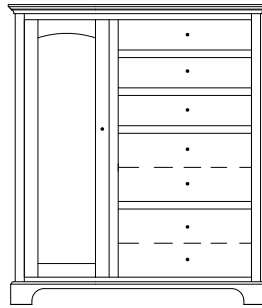

SO-128 Chifferobe
43¼"w 49½"h 21"d
w/5 drawers, 1 door, 2 adj. shelves

Option:
Mirror on
back of door

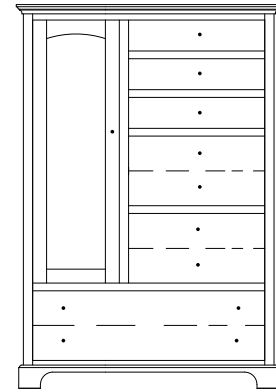

SO-129 Chifferobe
43¼"w 62"h 21"d
w/6 drawers, 1 door, 2 adj. shelves

Option:
Mirror on
back of door

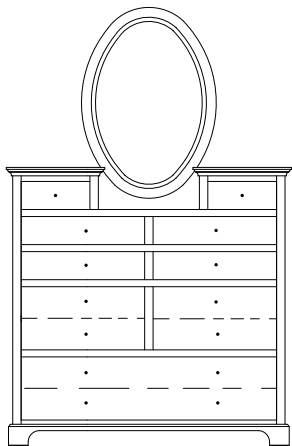

SO-136 Studio w/Mirror
51¼"w 80"h 21"d
w/9 drawers

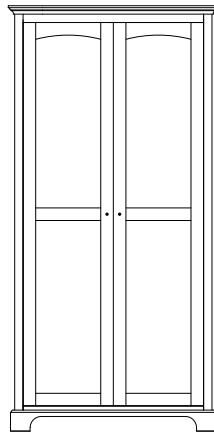

SO-159 Wardrobe
39"w 76"h 25½"d
w/2 doors, closet rod

Option:
Adjustable shelves

Full width drawer
inside doors in
bottom of unit

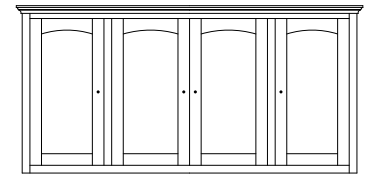

SO-35 Mule Chest Top
68¾"w 35½"h 21½"d
w/4 doors & 4 adjustable shelves

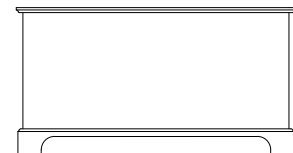

SO-164 Blanket Chest
42"w 22"h 21½"d

Available
with aromatic
cedar bottom

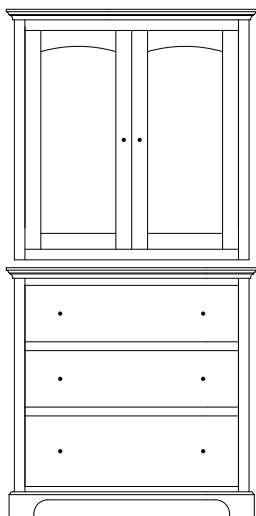

SO-25 Armoire Top
37"w 35½"h 21½"d
w/2 doors, 2 adj. shelves
w/1 wire hole in back

SO-123 Armoire Base
36"w 35½"h 21"d
w/3 drawers

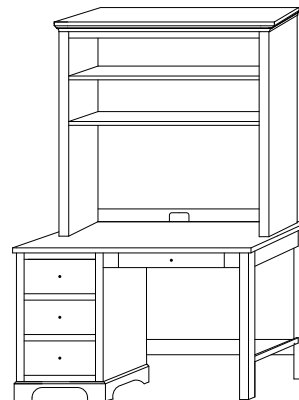

SO-197 Study Carrel
48"w 42"h 13"d
w/2 adjustable shelves

SO-199 Student Desk
48"w 29¼"h 22½"d
w/3 drawers
w/1 pencil drawer

Upgrades available on student desk:

Keyboard slideout instead of pencil drawer
File drawer instead of bottom 2 drawers

Sonora Dressers



SO-163 Dresser shown with **MI-2130 Mirror**

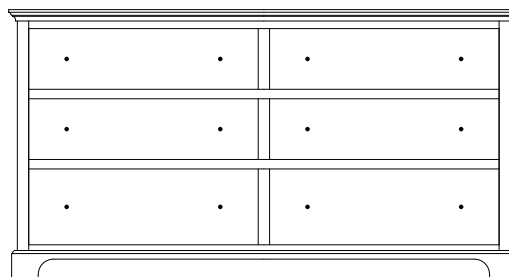

SO-131 Dresser
67¾"w 35½"h 21"d
w/6 drawers

Suggested Mirrors:

MI-2131 Mirror
40"h 46"w

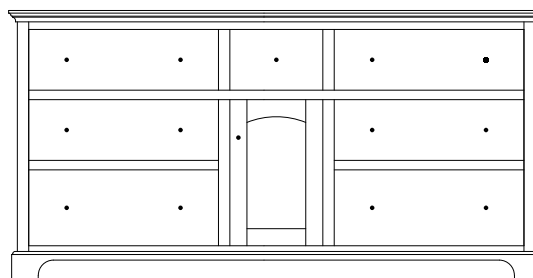

SO-132 Dresser
71"w 35½"h 21"d
w/7 drawers, 1 door,
1 adjustable shelf

Suggested Mirrors:

MI-2131 Mirror
40"h 46"w

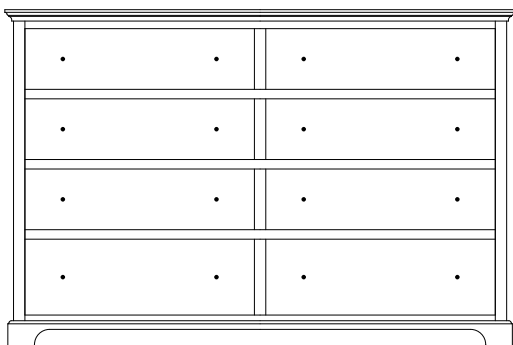

SO-134 Dresser
67¾"w 46¾"h 21"d
w/8 drawers

Suggested Mirrors:

MI-2133 Mirror
32"h 52"w

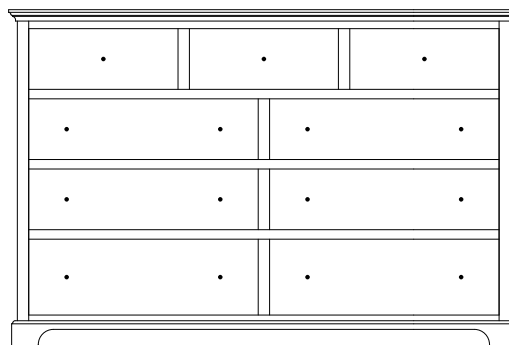

SO-144 Dresser
67¾"w 44¾"h 21"d
w/9 drawers

Suggested Mirrors:

MI-2133 Mirror
32"h 52"w

Sonora Dressers

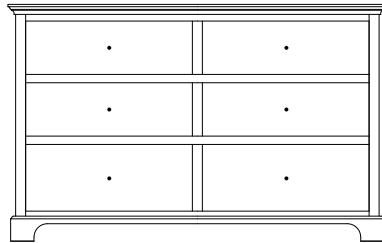

SO-130 Dresser
57¼"w 35½"h 21"d
w/6 drawers

Suggested Mirrors:

MI-2131 Mirror
40"h 46"w

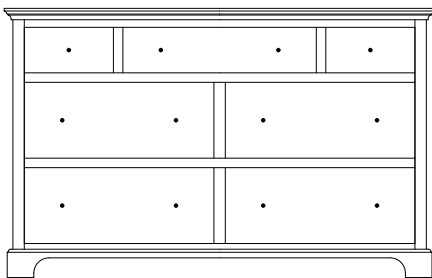

SO-163 Dresser
57¼"w 35½"h 21"d
w/7 drawers

Suggested Mirrors:

MI-2130 Mirror
40"h 36"w

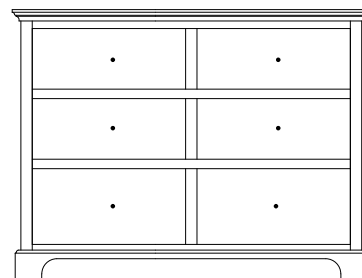

SO-165 Dresser
47¾"w 33½"h 21"d
w/6 drawers

Suggested Mirrors:

MI-2130 Mirror
40"h 36"w

Sonora Mirror



Beveled Mirror

MI-2130 Mirror
40"high 36"wide

MI-2131 Mirror
40"high 46"wide

MI-2132 Mirror
32"high 42"wide

MI-2133 Mirror
32"high 52"wide

Sonora Bed Frames



shown with Regular Footboard



shown with Regular Footboard

Panel Bed

Regular Footboard

Available with underbed storage options.

SO-1050-K (King)

82¼" w 87½" l

HB 52¾" h ■ FB 30¾" h

SO-1050-Q (Queen)

66⅝" w 87½" l

HB 52¾" h ■ FB 30¾" h

SO-1050-F (Full)

59½" w 82½" l

HB 52¾" h ■ FB 30¾" h

SO-1050-T (Twin)

44¾" w 82½" l

HB 52¾" h ■ FB 30¾" h

Low Footboard

SO-1052-K (King)

82¼" w 85¾" l

HB 52¾" h ■ FB 14¾" h

SO-1052-Q (Queen)

66⅝" w 85¾" l

HB 52¾" h ■ FB 14¾" h

SO-1052-F (Full)

59½" w 80¾" l

HB 52¾" h ■ FB 14¾" h

SO-1052-T (Twin)

44¾" w 80¾" l

HB 52¾" h ■ FB 14¾" h

Headboard Only

SO-1054K-HB (King)

52¾" high

SO-1054Q-HB (Queen)

52¾" high

SO-1054F-HB (Full)

52¾" high

SO-1054T-HB (Twin)

52¾" high

Sleepwell Bed

Regular Footboard

Available with underbed storage options.

SW-491-K (King)

79⅝" w 84½" l

HB 48" h ■ FB 30" h

SW-491-Q (Queen)

64⅝" w 84½" l

HB 48" h ■ FB 30" h

SW-491-F (Full)

56⅞" w 79½" l

HB 48" h ■ FB 30" h

SW-491-T (Twin)

42" w 79½" l

HB 48" h ■ FB 30" h

Low Footboard

SW-493-K (King)

79⅝" w 84½" l

HB 48" h ■ FB 14¾" h

SW-493-Q (Queen)

64⅝" w 84½" l

HB 48" h ■ FB 14¾" h

SW-493-F (Full)

56⅞" w 79½" l

HB 48" h ■ FB 14¾" h

SW-493-T (Twin)

42" w 79½" l

HB 48" h ■ FB 14¾" h

Headboard Only

SW-495K-HB (King)

48" high

SW-495Q-HB (Queen)

48" high

SW-495F-HB (Full)

48" high

SW-495T-HB (Twin)

48" high

Sonora Storage Rail Upgrades

12³/₄" From Floor to Box Spring

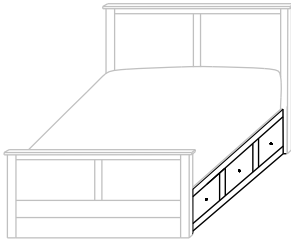

- With 3 drawers on each side
- 12³/₄" from floor to Box Spring
- Inside drawer dimensions on all sizes
9¹/₄"h 18⁷/₈"w 22¹/₂"d

532-SR-K King – 6 drawers
532-SR-Q Queen – 6 drawers
532-SR-F Full – 6 drawers
532-SR-T Twin – 3 drawers

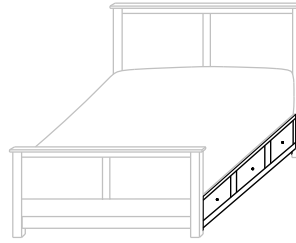

- With 3" Toe Kick
- With 3 drawers on each side
- 12³/₄" from floor to Box Spring
- Inside drawer dimensions on all sizes
6¹/₄"h 18⁷/₈"w 22¹/₂"d

234-SR-K King – 6 drawers
234-SR-Q Queen – 6 drawers
234-SR-F Full – 6 drawers
234-SR-T Twin – 3 drawers

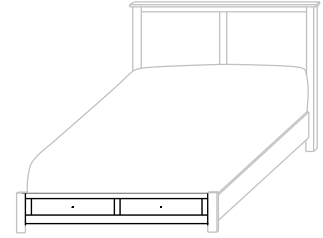

- 12³/₄" from floor to Box Spring
- Inside drawer dimensions
6¹/₄"h 22¹/₂"d
(King) 31" w (Queen) 23¹/₄" w
(Full) 19⁵/₈" w (Twin) 29¹/₄" w

685-FDS-K King – 2 drawers
685-FDS-Q Queen – 2 drawers
685-FDS-F Full – 2 drawers
685-FDS-T Twin – 1 drawer

19³/₄" From Floor to Box Spring

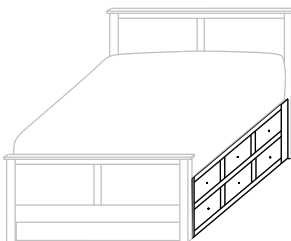

- With 6 drawers on each side
- Twin has 6 drawers on 1 side only
- 19³/₄" from floor to Box Spring
- Inside drawer dimensions on all sizes
6¹/₄"h 18⁷/₈"w 22¹/₂"d

654-SR-K King – 12 drawers
654-SR-Q Queen – 12 drawers
654-SR-F Full – 12 drawers
654-SR-T Twin – 6 drawers

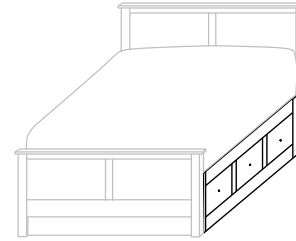

- With 3 drawers on each side
- 19³/₄" from floor to Box Spring
- Inside drawer dimensions on all sizes
10¹/₄"h 18⁷/₈"w 22¹/₂"d

325-SR-K King – 6 drawers
325-SR-Q Queen – 6 drawers
325-SR-F Full – 6 drawers
325-SR-T Twin – 3 drawers

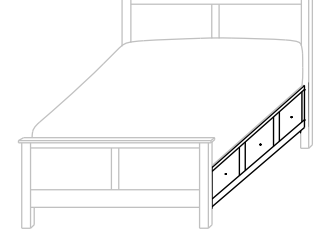

- With 7" Toe Kick
- With 3 drawers on each side
- 19³/₄" from floor to Box Spring
- Inside drawer dimensions on all sizes
9¹/₄"h 18⁷/₈"w 22¹/₂"d

236-SR-K King – 6 drawers
236-SR-Q Queen – 6 drawers
236-SR-F Full – 6 drawers
236-SR-T Twin – 3 drawers

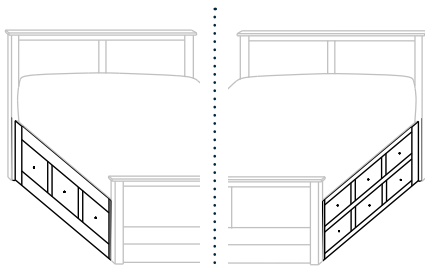

- With 3 drawers on one side and 6 drawers on other side
- 19³/₄" from floor to Box Spring

420-SR-K King – 9 drawers
420-SR-Q Queen – 9 drawers
420-SR-F Full – 9 drawers
 (Twin Not Available)

Additional Upgrades

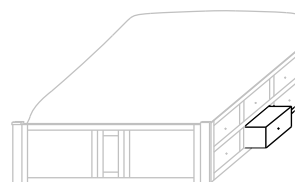

- With Step Stool Pullout in place of drawer

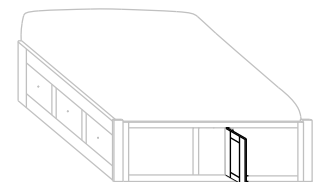

- With Door in Footboard to access area between rails





Timber Mill
Bedroom Collection

Timber Mill



Timber Mill Bedroom Collection

- TM-3365Q Queen Bed w/FDS 685 Upgrade
- TM-3342 Night Stand
- TM-3350 Chest
- TM-3358 Dresser
- MI-3333 Mirror

Features: 1¼" Plank Tops with Breadboard ends & Random Saw Marks

Shown above in **Rustic Cherry** with **105 Black Walnut** with **P2170-BI Knobs** and **P2171-BI Pulls**

Standard Features:



P2170-BI Knobs & P2171-BI Pulls



Standard with side-mount drawer slides

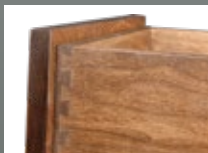

Stained poplar dovetailed drawers



Dovetailed bed slats

Available Upgrades:

- Any hardware on our Hardware Options Sheet
- Undermount soft close slides [See Price List]



- HT-2125Q Queen Bed
- TM-3345 Night Stand
- TM-3351 Hi-Boy
- TM-3357 Dresser
- MI-3332 Mirror

Shown in *Rustic Hickory Natural* with *FG-20018 Glaze* and *P2170-BI Knobs* and *P2171-BI Pulls*

Timber Mill Night Stands



TM-3345
Night Stand shown



**Sliding Top Option available
in all Nightstands**
(Hidden compartment w/lock)

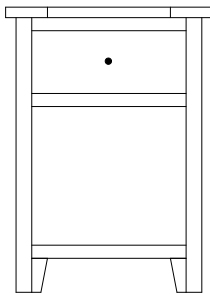

TM-3340 Night Stand
19¾"w 27½"h 17½"d
w/1 drawer

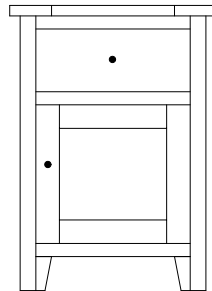

TM-3341 Night Stand
19¾"w 27½"h 17½"d
w/1 drawer, 1 door

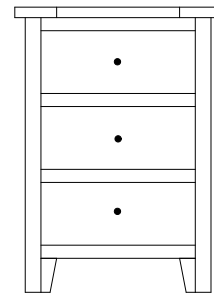

TM-3342 Night Stand
19¾"w 27½"h 17½"d
w/3 drawers

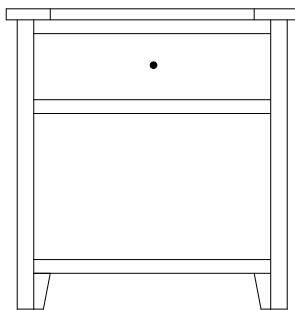

TM-3343 Night Stand
26½"w 27½"h 17½"d
w/1 drawer

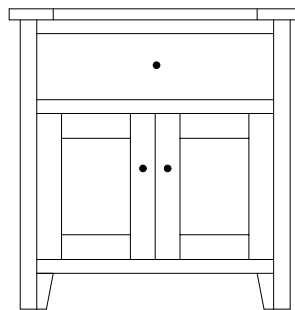

TM-3344 Night Stand
26½"w 27½"h 17½"d
w/1 drawer, 2 doors

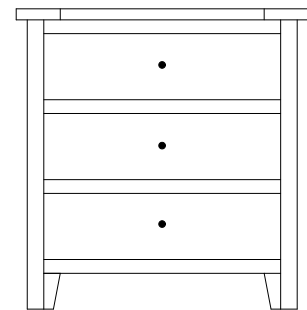

TM-3345 Night Stand
26½"w 27½"h 17½"d
w/3 drawers

Timber Mill Lingeries & Chests



TM-351
Hi-Boy shown

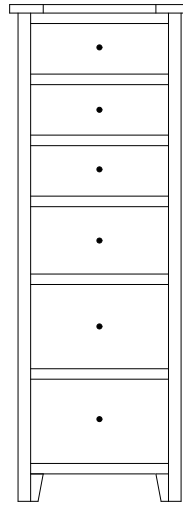

TM-3346 Lingerie
21 $\frac{3}{8}$ "w 59 $\frac{1}{4}$ "h 21 $\frac{1}{2}$ "d
w/6 drawers

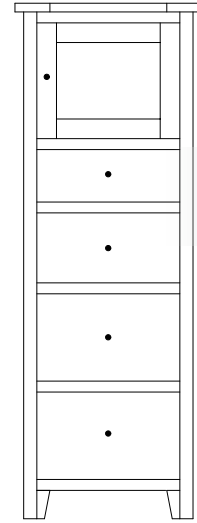

Available with
mirror in
door panel

TM-3347 Lingerie
21 $\frac{3}{8}$ "w 59 $\frac{1}{4}$ "h 21 $\frac{1}{2}$ "d
w/4 drawers, 1 wood door,
1 adjustable shelf

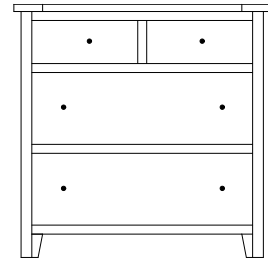

TM-3349 Chest
35 $\frac{3}{4}$ "w 35 $\frac{1}{2}$ "h 21 $\frac{1}{2}$ "d
w/4 drawers

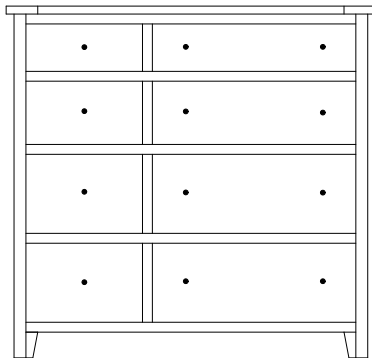

TM-3348 Chest
46 $\frac{3}{4}$ "w 44 $\frac{3}{4}$ "h 21 $\frac{1}{2}$ "d
w/8 drawers

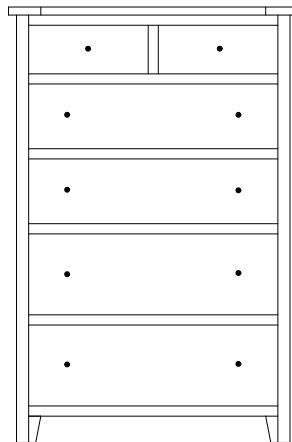

TM-3350 Chest
35 $\frac{3}{4}$ "w 54"h 21 $\frac{1}{2}$ "d
w/6 drawers

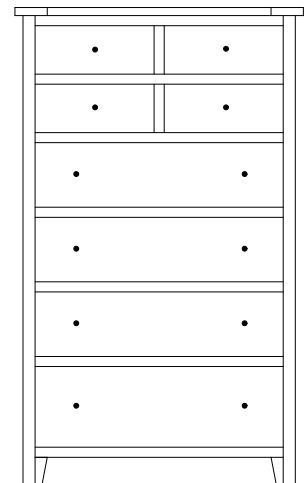

TM-3351 Hi-Boy
35 $\frac{3}{4}$ "w 59 $\frac{1}{4}$ "h 21 $\frac{1}{2}$ "d
w/8 drawers

Timber Mill Miscellaneous

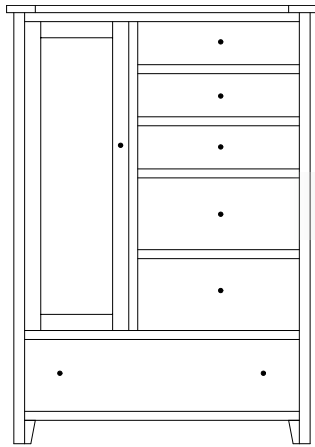

Option:
Mirror on
back of door

TM-3352 Chifferobe
43¼"w 61¼"h 21½"d
w/6 drawers, 1 door, 2 adj. shelves

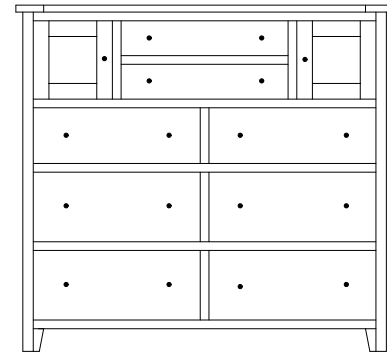

TM-3353 His & Hers Chest
54¼"w 50"h 21½"d
w/8 drawers, 2 doors

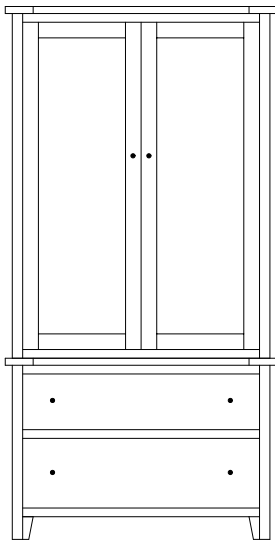

TM-3362 Armoire
39"w 76½"h 21½"d
w/2 drawers, (top drawer w/divider)
w/2 doors, 2 adj. shelves & closet rod

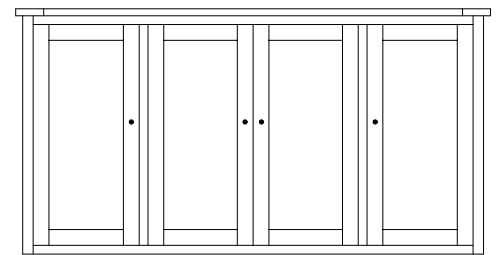

TM-3359 Mule Chest Top
67¾"w 35"h 21½"d
w/4 doors & 6 adjustable shelves

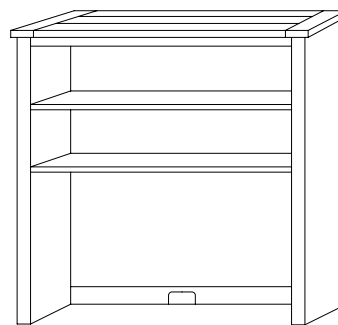

TM-3397 Study Carrel
48"w 42¼"h 13"d
w/2 adjustable shelves

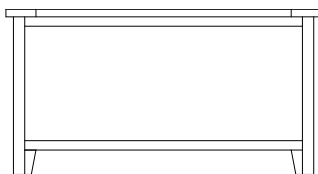

TM-3335 Blanket Chest
42"w 22"h 21½"d

Available
with aromatic
cedar bottom

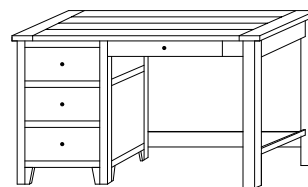

TM-3399 Student Desk
48"w 29"h 23"d
w/3 drawers
w/1 pencil drawer

Upgrades available on student desk:

Keyboard slideout instead of pencil drawer
File drawer instead of bottom 2 drawers

Timber Mill Dressers



TM-3357 Dresser shown with MI-3332 Mirror

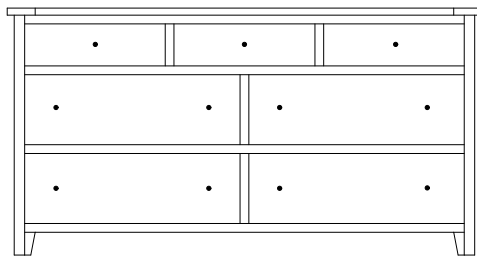

TM-3355 Dresser
67 $\frac{3}{4}$ "w 35 $\frac{1}{2}$ "h 21 $\frac{1}{2}$ "d
w/7 drawers

Suggested Mirrors:

MI-3331 Mirror
40"h 46"w

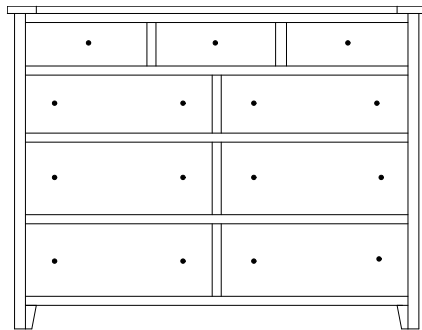

TM-3357 Dresser
57 $\frac{3}{4}$ "w 44 $\frac{3}{4}$ "h 21 $\frac{1}{2}$ "d
w/9 drawers

Suggested Mirrors:

MI-3332 Mirror
32"h 42"w

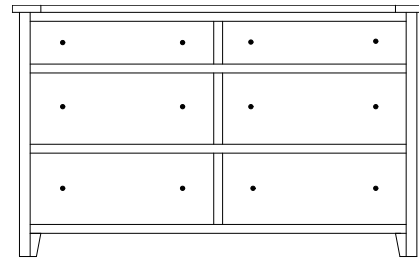

TM-3354 Dresser
57 $\frac{3}{4}$ "w 35 $\frac{1}{2}$ "h 21 $\frac{1}{2}$ "d
w/6 drawers

Suggested Mirrors:

MI-3330 Mirror
40"h 36"w

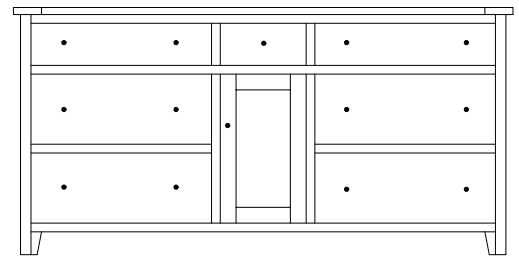

TM-3356 Dresser
71 $\frac{1}{4}$ "w 35 $\frac{1}{2}$ "h 21 $\frac{1}{2}$ "d
w/7 drawers, 1 door
w/1 adjustable shelf

Suggested Mirrors:

MI-3331 Mirror
40"h 46"w

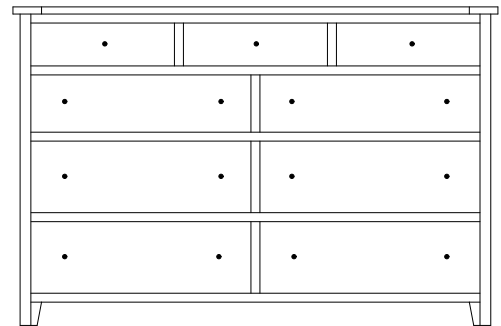

TM-3358 Dresser
67 $\frac{3}{4}$ "w 44 $\frac{3}{4}$ "h 21 $\frac{1}{2}$ "d
w/9 drawers

Suggested Mirrors:

MI-3333 Mirror
32"h 52"w

Timber Mill Mirrors



MI-3330 Mirror
40"h 36"w

MI-3331 Mirror
40"h 46"w

MI-3332 Mirror
32"h 42"w

MI-3333 Mirror
32"h 52"w

Beveled Mirror

Timber Mill Bed Frames



Bed shown with 234-SR Storage Upgrade and Regular Footboard



Shown with Regular Footboard and 685 Storage Upgrade

Huntington Bed Regular Footboard

Available with underbed storage options.

HT-2125K (King)
83⁵/₈"w 91"l
HB 63¹/₄"h ■ FB 29"h

HT-2125Q (Queen)
68"w 91"l
HB 63¹/₄"h ■ FB 29"h

HT-2125F (Full)
60⁷/₈"w 86"l
HB 63¹/₄"h ■ FB 29"h

HT-2125T (Twin)
46"w 86"l
HB 63¹/₄"h ■ FB 29"h

Low Footboard

HT-2126K (King)
83⁵/₈"w 87³/₄"l
HB 63¹/₄"h ■ FB 29"h

HT-2126Q (Queen)
68"w 87³/₄"l
HB 63¹/₄"h ■ FB 29"h

HT-2126F (Full)
60⁷/₈"w 82³/₄"l
HB 63¹/₄"h ■ FB 29"h

HT-2126T (Twin)
46"w 82³/₄"l
HB 63¹/₄"h ■ FB 29"h

Headboard Only

HT-2127K-HB (King)
63¹/₄" high

HT-2127Q-HB (Queen)
63¹/₄" high

HT-2127F-HB (Full)
63¹/₄" high

HT-2127T-HB (Twin)
63¹/₄" high

Timber Mill Bed

Available with underbed storage options.

Regular Footboard

TM-3365-K (King)
79⁵/₈"w 85¹/₂"l
HB 55"h ■ FB 33¹/₄"h

TM-3365-Q (Queen)
64"w 85¹/₂"l
HB 55"h ■ FB 33¹/₄"h

TM-3365-F (Full)
56⁷/₈"w 80¹/₂"l
HB 55"h ■ FB 33¹/₄"h

TM-3365-T (Twin)
42"w 80¹/₂"l
HB 47"h ■ FB 31"h

Low Footboard

TM-3366-K (King)
79³/₄"w 85"l
HB 55"h ■ FB 14³/₄"h

TM-3366-Q (Queen)
64"w 85"l
HB 55"h ■ FB 14³/₄"h

TM-3366-F (Full)
56⁷/₈"w 80"l
HB 55"h ■ FB 14³/₄"h

TM-3366-T (Twin)
42"w 80"l
HB 55"h ■ FB 14³/₄"h

Headboard Only

TM-3367K-HB (King)
55" high

TM-3367Q-HB (Queen)
55" high

TM-3367F-HB (Full)
55" high

TM-3367T-HB (Twin)
55" high

Timber Mill Storage Rail Upgrades

12³/₄" From Floor to Box Spring

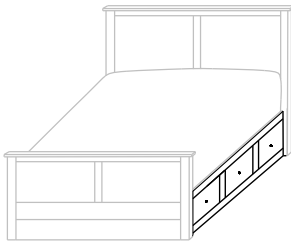

- With 3 drawers on each side
- 12³/₄" from floor to Box Spring
- Inside drawer dimensions on all sizes
9¹/₄"h 18⁷/₈"w 22¹/₂"d

532-SR-K King – 6 drawers
532-SR-Q Queen – 6 drawers
532-SR-F Full – 6 drawers
532-SR-T Twin – 3 drawers

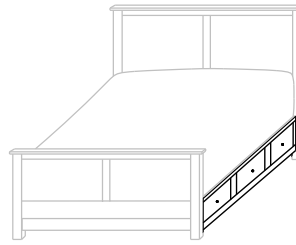

- With 3" Toe Kick
- With 3 drawers on each side
- 12³/₄" from floor to Box Spring
- Inside drawer dimensions on all sizes
6¹/₄"h 18⁷/₈"w 22¹/₂"d

234-SR-K King – 6 drawers
234-SR-Q Queen – 6 drawers
234-SR-F Full – 6 drawers
234-SR-T Twin – 3 drawers

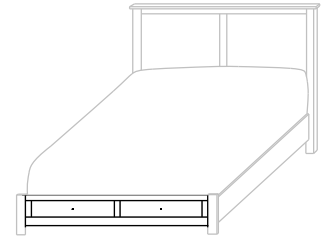

- 12³/₄" from floor to Box Spring
- Inside drawer dimensions
6¹/₄"h 22¹/₂"d
(King) 31" w (Queen) 23¹/₄" w
(Full) 19⁵/₈" w (Twin) 29¹/₄" w

685-FDS-K King – 2 drawers
685-FDS-Q Queen – 2 drawers
685-FDS-F Full – 2 drawers
685-FDS-T Twin – 1 drawer

19³/₄" From Floor to Box Spring

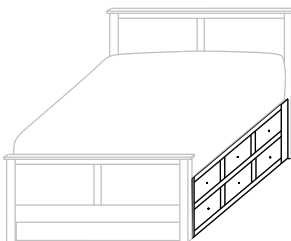

- With 6 drawers on each side
- Twin has 6 drawers on 1 side only
- 19³/₄" from floor to Box Spring
- Inside drawer dimensions on all sizes
6¹/₄"h 18⁷/₈"w 22¹/₂"d

654-SR-K King – 12 drawers
654-SR-Q Queen – 12 drawers
654-SR-F Full – 12 drawers
654-SR-T Twin – 6 drawers

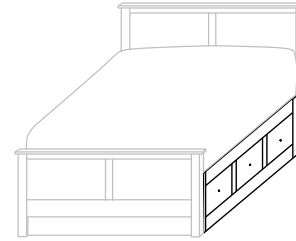

- With 3 drawers on each side
- 19³/₄" from floor to Box Spring
- Inside drawer dimensions on all sizes
10¹/₄"h 18⁷/₈"w 22¹/₂"d

325-SR-K King – 6 drawers
325-SR-Q Queen – 6 drawers
325-SR-F Full – 6 drawers
325-SR-T Twin – 3 drawers

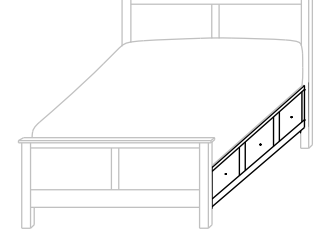

- With 7" Toe Kick
- With 3 drawers on each side
- 19³/₄" from floor to Box Spring
- Inside drawer dimensions on all sizes
9¹/₄"h 18⁷/₈"w 22¹/₂"d

236-SR-K King – 6 drawers
236-SR-Q Queen – 6 drawers
236-SR-F Full – 6 drawers
236-SR-T Twin – 3 drawers

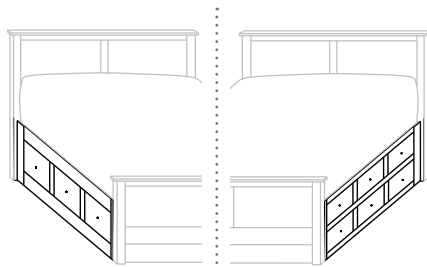

- With 3 drawers on one side and 6 drawers on other side
- 19³/₄" from floor to Box Spring

420-SR-K King – 9 drawers
420-SR-Q Queen – 9 drawers
420-SR-F Full – 9 drawers
 (Twin Not Available)

Additional Upgrades

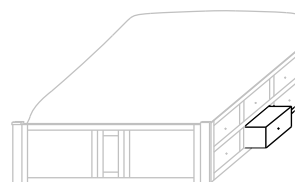

- With Step Stool Pullout in place of drawer

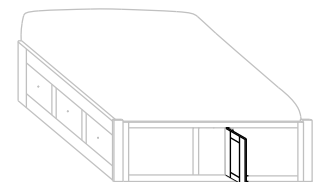

- With Door in Footboard to access area between rails





Wilkenburg
Bedroom Collection

Wilkenburg



Wilkenburg Bedroom Collection w/Wilkenburg Bed

- WB-1738Q Queen Bed
- WB-1740 Night Stand
- WB-1750 Chest
- WB-1754 Dresser
- MI-1365 Mirror

Shown above in **Brown Maple** with **OCS-113 Michaels** and **1½" Wood Knobs**

Standard Features:



1½" Wood Knobs



Standard with side-mount drawer slides

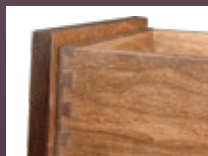

Stained poplar drawer boxes



Dovetailed bed slats

Available Upgrades:

- Any hardware on our Hardware Options Sheet
- Undermount soft close slides [See Price List]



- 2-WB-1738T Twin Wilkenburg Beds
- 2-WB-1741 Night Stands
- WB-1754 Dresser
- MI-1365 Mirror

Shown in **Brown Maple** with **RNC-1160 Quench Blue** and **1½" Wood Knobs**

Wilkenburg Night Stands



WB-1741
Night Stand shown



Sliding top option available on all night stands
(Hidden compartment w/Lock)

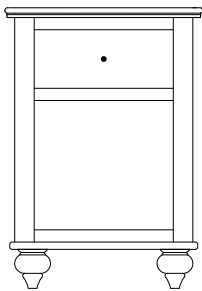

WB-1740 Night Stand
20½"w 28¾"h 19"d
w/1 drawer

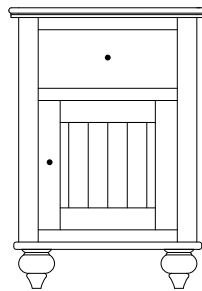

WB-1741 Night Stand
20½"w 28¾"h 19"d
w/1 drawer, 1 door

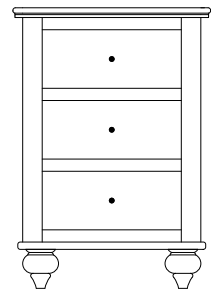

WB-1742 Night Stand
20½"w 28¾"h 19"d
w/3 drawers

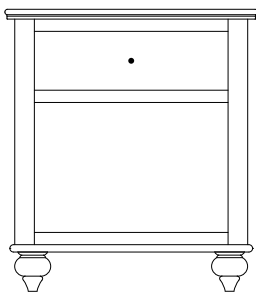

WB-1743 Night Stand
25¾"w 28¾"h 19"d
w/1 drawer

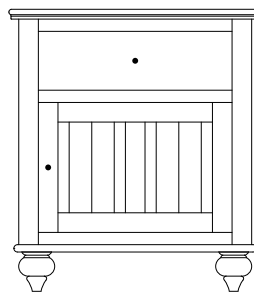

WB-1744 Night Stand
25¾"w 28¾"h 19"d
w/1 drawer, 1 door

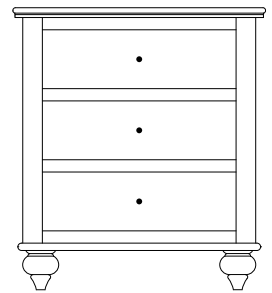

WB-1745 Night Stand
25¾"w 28¾"h 19"d
w/3 drawers

Wilkenburg Lingeries & Chests



WB-1750
Chest shown

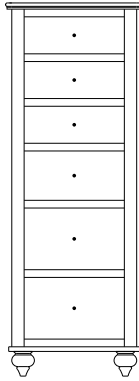

WB-1746 Lingerie
22 1/4"w 60 1/2"h 21"d
w/6 drawers

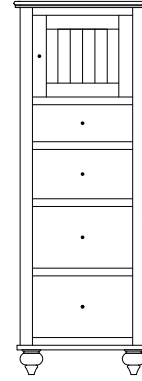

Available with
mirror in
door panel

WB-1747 Lingerie
22 1/4"w 60 1/2"h 21"d
w/4 drawers, 1 door,
1 adjustable shelf

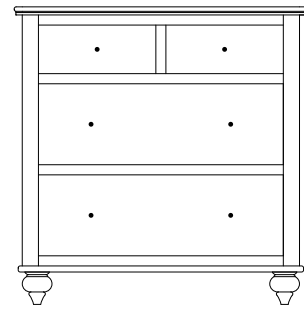

WB-1749 Chest
36 1/4"w 36 3/4"h 21"d
w/4 drawers

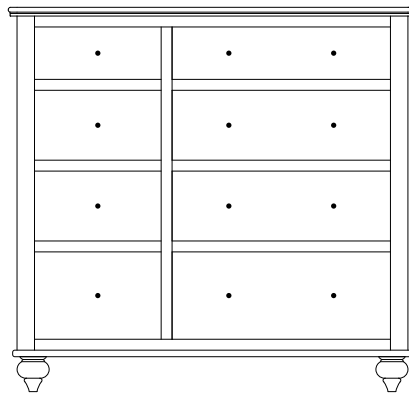

WB-1748 Chest
46 3/4"w 44"h 21"d
w/8 drawers

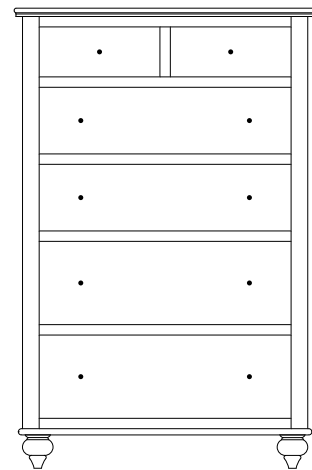

WB-1750 Chest
36 1/4"w 55 1/4"h 21"d
w/6 drawers

Wilkenburg Miscellaneous

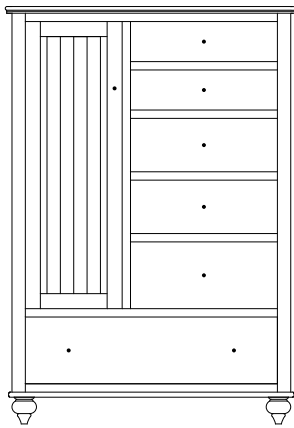

Option:
Mirror on
back of door

WB-1752 Chifferobe
43¾"w 62½"h 21"d
w/6 drawers, 1 door, 2 adj. shelves

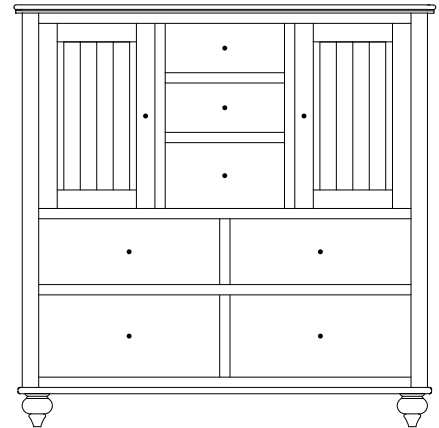

WB-1753 His & Hers
51¼"w 51¼"h 21"d
w/7 drawers, 2 doors

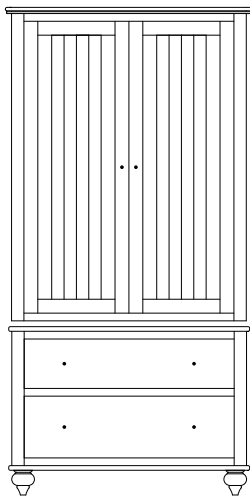

WB-1762 Armoire
40"w 78"h 21"d
w/2 drawers (top drawer w/divider)
w/2 doors 2 adj. shelves & closet rod

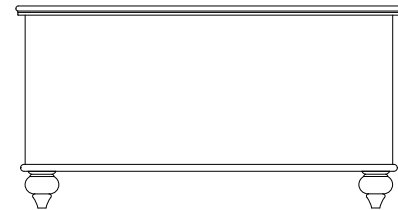

WB-1735 Blanket Chest
42"w 22"h 21½"d

Available
with aromatic
cedar bottom

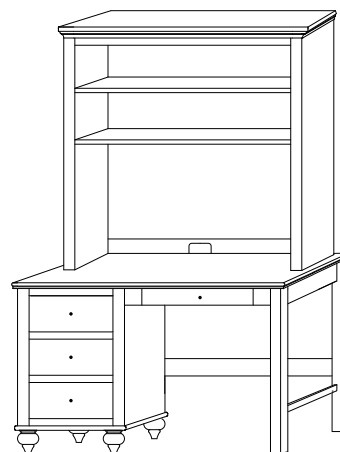

WB-1797 Study Carrel
48"w 42"h 13"d
w/2 adjustable shelves

WB-1799 Student Desk
48"w 29½"h 22½"d
w/3 drawers
w/1 pencil drawer

Upgrades available on student desk:

Keyboard slideout instead of pencil drawer
File drawer instead of bottom 2 drawers

Wilkenburg Dressers



WB-1754 Dresser shown with MI-1365 Mirror

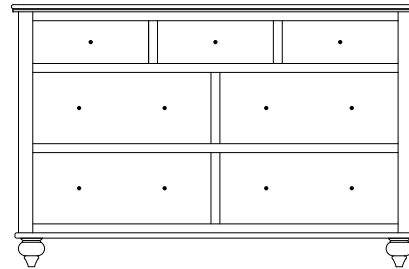

WB-1754 Dresser
57¼"w 36¾"h 21"d
w/7 drawers

Suggested Mirrors:

MI-1365 Mirror
40"h 36"w

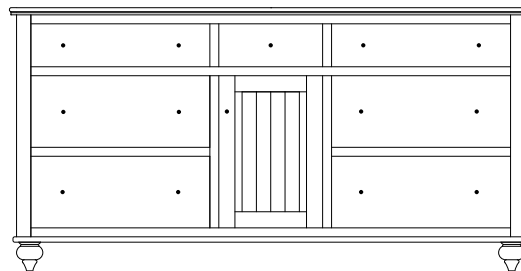

WB-1756 Dresser
73"w 36¾"h 21"d
w/7 drawers, 1 door
w/1 adjustable shelf

Suggested Mirrors:

MI-1366 Mirror
40"h 46"w

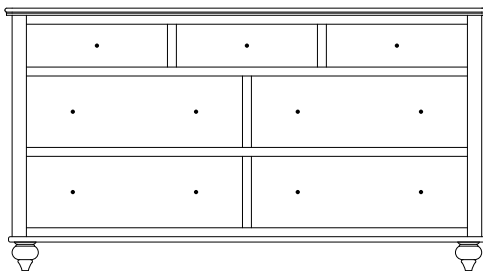

WB-1755 Dresser
67¾"w 36¾"h 21"d
w/7 drawers

Suggested Mirrors:

MI-1366 Mirror
40"h 46"w

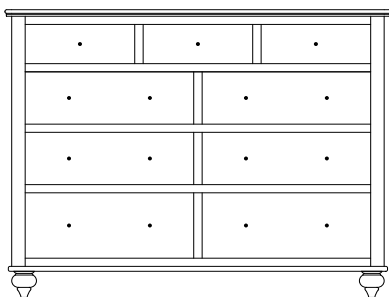

WB-1757 Tall Dresser
57¼"w 44"h 21"d
w/9 drawers

Suggested Mirrors:

MI-1367 Mirror
32"h 42"w

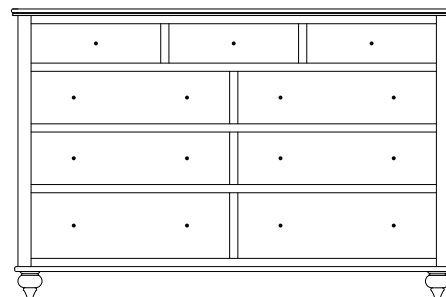

WB-1758 Tall Dresser
67¾"w 44"h 21"d
w/9 drawers

Suggested Mirrors:

MI-1368 Mirror
32"h 52"w



MI-1365 Mirror
40"high 36"wide

MI-1366 Mirror
40"high 46"wide

MI-1367 Mirror
32"high 42"wide

MI-1368 Mirror
32"high 52"wide

Beveled Mirror

Wilkenburg Bed Frames



shown with Low Footboard

Wilkenburg Bed

Regular Footboard

WB-1736-K (King)
81 5/8"w 86 1/2"l
HB 53"h ■ FB 30"h

WB-1736-Q (Queen)
66"w 86 1/2"l
HB 53"h ■ FB 30"h

WB-1736-F (Full)
58 7/8"w 81 1/2"l
HB 53"h ■ FB 30"h

WB-1736-T (Twin)
44"w 81 1/2"l
HB 53"h ■ FB 30"h

Available
with underbed
storage options.

Low Footboard

WB-1738-K (King)
81 5/8"w 85 1/2"l
HB 53"h ■ FB 14 3/4"h

WB-1738-Q (Queen)
66"w 85 1/2"l
HB 53"h ■ FB 14 3/4"h

WB-1738-F (Full)
58 7/8"w 80 1/2"l
HB 53"h ■ FB 14 3/4"h

WB-1738-T (Twin)
44"w 80 1/2"l
HB 53"h ■ FB 14 3/4"h

Headboard Only

WB-1741-HB-K (King)
53" high

WB-1741-HB-Q (Queen)
53" high

WB-1741-HB-F (Full)
53" high

WB-1741-HB-T (Twin)
53" high

Wilkensburg Storage Rail Upgrades

12³/₄" From Floor to Box Spring

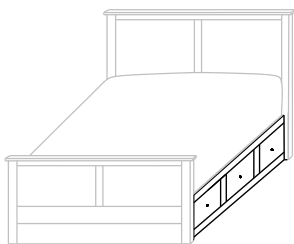

- With 3 drawers on each side
- 12³/₄" from floor to Box Spring
- Inside drawer dimensions on all sizes
9¹/₄"h 18⁷/₈"w 22¹/₂"d

532-SR-K King – 6 drawers
532-SR-Q Queen – 6 drawers
532-SR-F Full – 6 drawers
532-SR-T Twin – 3 drawers

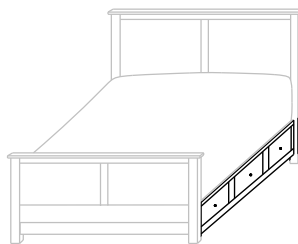

- With 3" Toe Kick
- With 3 drawers on each side
- 12³/₄" from floor to Box Spring
- Inside drawer dimensions on all sizes
6¹/₄"h 18⁷/₈"w 22¹/₂"d

234-SR-K King – 6 drawers
234-SR-Q Queen – 6 drawers
234-SR-F Full – 6 drawers
234-SR-T Twin – 3 drawers

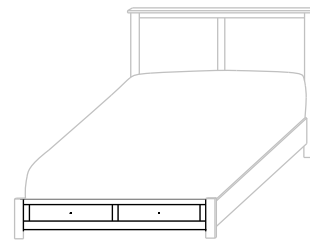

- 12³/₄" from floor to Box Spring
- Inside drawer dimensions
6¹/₄"h 22¹/₂"d
 (King) 31" w (Queen) 23¹/₄" w
 (Full) 19⁵/₈" w (Twin) 29¹/₄" w

685-FDS-K King – 2 drawers
685-FDS-Q Queen – 2 drawers
685-FDS-F Full – 2 drawers
685-FDS-T Twin – 1 drawer

19³/₄" From Floor to Box Spring

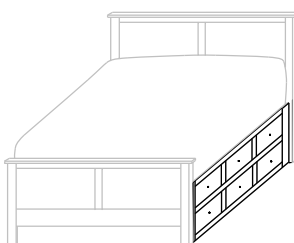

- With 6 drawers on each side
- Twin has 6 drawers on 1 side only
- 19³/₄" from floor to Box Spring
- Inside drawer dimensions on all sizes
6¹/₄"h 18⁷/₈"w 22¹/₂"d

654-SR-K King – 12 drawers
654-SR-Q Queen – 12 drawers
654-SR-F Full – 12 drawers
654-SR-T Twin – 6 drawers

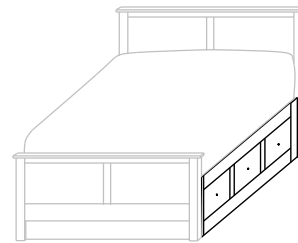

- With 3 drawers on each side
- 19³/₄" from floor to Box Spring
- Inside drawer dimensions on all sizes
10¹/₄"h 18⁷/₈"w 22¹/₂"d

325-SR-K King – 6 drawers
325-SR-Q Queen – 6 drawers
325-SR-F Full – 6 drawers
325-SR-T Twin – 3 drawers

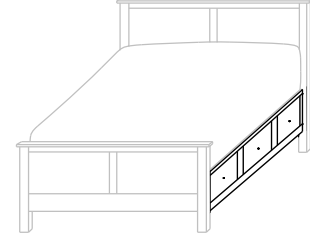

- With 7" Toe Kick
- With 3 drawers on each side
- 19³/₄" from floor to Box Spring
- Inside drawer dimensions on all sizes
9¹/₄"h 18⁷/₈"w 22¹/₂"d

236-SR-K King – 6 drawers
236-SR-Q Queen – 6 drawers
236-SR-F Full – 6 drawers
236-SR-T Twin – 3 drawers

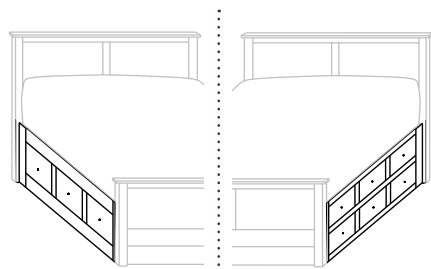

- With 3 drawers on one side and 6 drawers on other side
- 19³/₄" from floor to Box Spring

420-SR-K King – 9 drawers
420-SR-Q Queen – 9 drawers
420-SR-F Full – 9 drawers
 (Twin Not Available)

Additional Upgrades

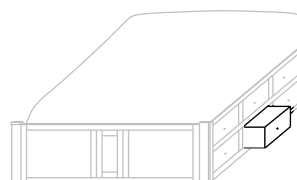

- With Step Stool Pullout in place of drawer

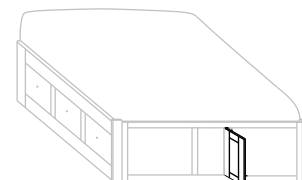

- With Door in Footboard to access area between rails

Bed Details

Dimensions for all Beds with Regular Rails

- 9 $\frac{7}{8}$ " from floor to top of slats
- 8" from floor to bottom of rails
- 6" high rails



Storage Rail System

- Available on all beds or sold separate
- 2 height options

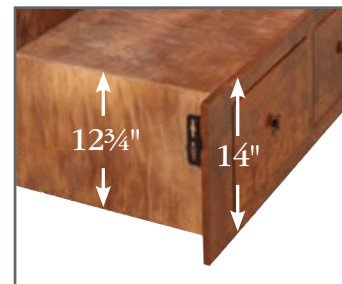

Footboard Drawer System

- Available on all beds or sold separate



Storage Rail Upgrades

12³/₄" From Floor to Box Spring

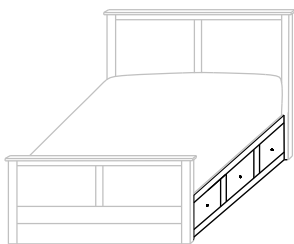

- With 3 drawers on each side
- 12³/₄" from floor to Box Spring
- Inside drawer dimensions on all sizes
9¹/₄"h 18⁷/₈"w 22¹/₂"d

532-SR-K King – 6 drawers
532-SR-Q Queen – 6 drawers
532-SR-F Full – 6 drawers
532-SR-T Twin – 3 drawers

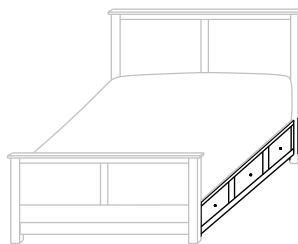

- With 3" Toe Kick
- With 3 drawers on each side
- 12³/₄" from floor to Box Spring
- Inside drawer dimensions on all sizes
6¹/₄"h 18⁷/₈"w 22¹/₂"d

234-SR-K King – 6 drawers
234-SR-Q Queen – 6 drawers
234-SR-F Full – 6 drawers
234-SR-T Twin – 3 drawers

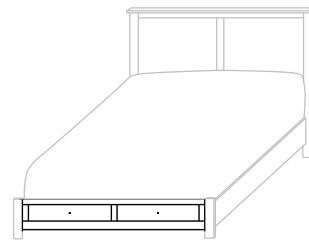

- 12³/₄" from floor to Box Spring
- Inside drawer dimensions
6¹/₄"h 22¹/₂"d
(King) 31" w (Queen) 23¹/₄" w
(Full) 19⁵/₈" w (Twin) 29¹/₄" w

685-FDS-K King – 2 drawers
685-FDS-Q Queen – 2 drawers
685-FDS-F Full – 2 drawers
685-FDS-T Twin – 1 drawer

19³/₄" From Floor to Box Spring

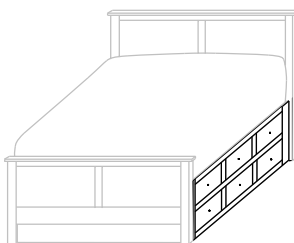

- With 6 drawers on each side
- Twin has 6 drawers on 1 side only
- 19³/₄" from floor to Box Spring
- Inside drawer dimensions on all sizes
6¹/₄"h 18⁷/₈"w 22¹/₂"d

654-SR-K King – 12 drawers
654-SR-Q Queen – 12 drawers
654-SR-F Full – 12 drawers
654-SR-T Twin – 6 drawers

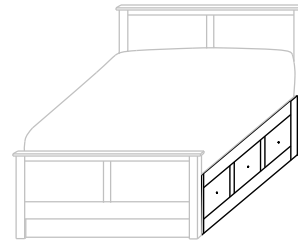

- With 3 drawers on each side
- 19³/₄" from floor to Box Spring
- Inside drawer dimensions on all sizes
10¹/₄"h 18⁷/₈"w 22¹/₂"d

325-SR-K King – 6 drawers
325-SR-Q Queen – 6 drawers
325-SR-F Full – 6 drawers
325-SR-T Twin – 3 drawers

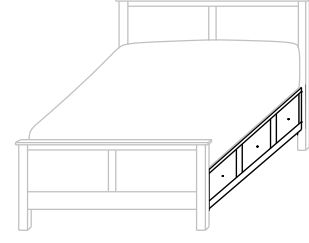

- With 7" Toe Kick
- With 3 drawers on each side
- 19³/₄" from floor to Box Spring
- Inside drawer dimensions on all sizes
9¹/₄"h 18⁷/₈"w 22¹/₂"d

236-SR-K King – 6 drawers
236-SR-Q Queen – 6 drawers
236-SR-F Full – 6 drawers
236-SR-T Twin – 3 drawers

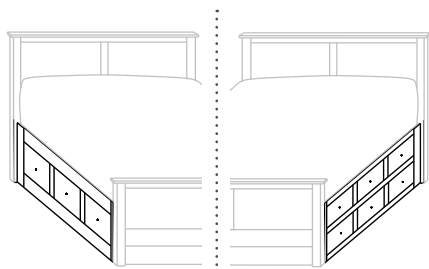

- With 3 drawers on one side and 6 drawers on other side
- 19³/₄" from floor to Box Spring

420-SR-K King – 9 drawers
420-SR-Q Queen – 9 drawers
420-SR-F Full – 9 drawers
 (Twin Not Available)

Additional Upgrades

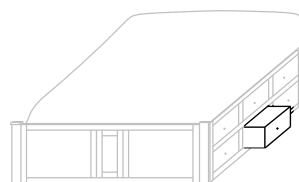

- With Step Stool Pullout in place of drawer

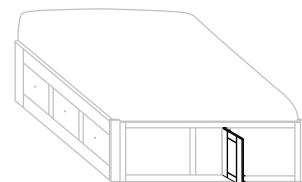

- With Door in Footboard to access area between rails



Shown with Regular Footboard



Shown with Regular Footboard

Allentown Bed

Available
with underbed
storage options.

Regular Footboard

AL-4017-K (King)
84 $\frac{5}{8}$ "w 87 $\frac{3}{4}$ "l
HB 48"h ■ FB 18"h

AL-4017-Q (Queen)
69"w 87 $\frac{3}{4}$ "l
HB 48"h ■ FB 18"h

AL-4017-F (Full)
61 $\frac{7}{8}$ "w 82 $\frac{3}{4}$ "l
HB 48"h ■ FB 18"h

AL-4017-T (Twin)
47"w 82 $\frac{3}{4}$ "l
HB 48"h ■ FB 18"h

Low Footboard

AL-4025-K (King)
84 $\frac{5}{8}$ "w 87 $\frac{3}{4}$ "l
HB 48"h ■ FB 14 $\frac{3}{4}$ "h

AL-4025-Q (Queen)
69"w 87 $\frac{3}{4}$ "l
HB 48"h ■ FB 14 $\frac{3}{4}$ "h

AL-4025-F (Full)
61 $\frac{7}{8}$ "w 82 $\frac{3}{4}$ "l
HB 48"h ■ FB 14 $\frac{3}{4}$ "h

AL-4025-T (Twin)
47"w 82 $\frac{3}{4}$ "l
HB 48"h ■ FB 14 $\frac{3}{4}$ "h

Headboard Only

AL-4033K-HB (King)
48" high

AL-4033Q-HB (Queen)
48" high

AL-4033F-HB (Full)
48" high

AL-4033T-HB (Twin)
48" high

Antique Mission Bed

Available
with underbed
storage options.

Regular Footboard

AM-2615-K (King)
82 $\frac{5}{8}$ "w 88"l
HB 52 $\frac{3}{4}$ "h ■ FB 27 $\frac{1}{2}$ "h

AM-2615-Q (Queen)
67"w 88"l
HB 52 $\frac{3}{4}$ "h ■ FB 27 $\frac{1}{2}$ "h

AM-2615-F (Full)
59 $\frac{7}{8}$ "w 83"l
HB 52 $\frac{3}{4}$ "h ■ FB 27 $\frac{1}{2}$ "h

AM-2615-T (Twin)
45"w 83"l
HB 52 $\frac{3}{4}$ "h ■ FB 27 $\frac{1}{2}$ "h

Low Footboard

AM-2616-K (King)
82 $\frac{5}{8}$ "w 86 $\frac{1}{4}$ "l
HB 52 $\frac{3}{4}$ "h ■ FB 14 $\frac{3}{4}$ "h

AM-2616-Q (Queen)
67"w 86 $\frac{1}{4}$ "l
HB 52 $\frac{3}{4}$ "h ■ FB 14 $\frac{3}{4}$ "h

AM-2616-F (Full)
59 $\frac{7}{8}$ "w 81 $\frac{1}{4}$ "l
HB 52 $\frac{3}{4}$ "h ■ FB 14 $\frac{3}{4}$ "h

AM-2616-T (Twin)
45"w 81 $\frac{1}{4}$ "l
HB 52 $\frac{3}{4}$ "h ■ FB 14 $\frac{3}{4}$ "h

Headboard Only

AM-2617K-HB (King)
52 $\frac{3}{4}$ " high

AM-2617Q-HB (Queen)
52 $\frac{3}{4}$ " high

AM-2617F-HB (Full)
52 $\frac{3}{4}$ " high

AM-2617T-HB (Twin)
52 $\frac{3}{4}$ " high



Shown with Low Footboard



Shown with Regular Footboard

Arch Spindle Bed

Available with underbed storage options.

Regular Footboard

AS-2625-K (King)
79⁵/₈"w 84¹/₂"l
HB 48"h ■ FB 30"h

AS-2625-Q (Queen)
64"w 84¹/₂"l
HB 48"h ■ FB 30"h

AS-2625-F (Full)
56⁷/₈"w 79¹/₂"l
HB 48"h ■ FB 30"h

AS-2625-T (Twin)
42"w 79¹/₂"l
HB 48"h ■ FB 30"h

Low Footboard

AS-2626-K (King)
79⁵/₈"w 84¹/₂"l
HB 48"h ■ FB 14³/₄"h

AS-2626-Q (Queen)
64"w 84¹/₂"l
HB 48"h ■ FB 14³/₄"h

AS-2626-F (Full)
56⁷/₈"w 79¹/₂"l
HB 48"h ■ FB 14³/₄"h

AS-2626-T (Twin)
42"w 79¹/₂"l
HB 48"h ■ FB 14³/₄"h

Headboard Only

AS-2627K-HB (King)
48" high

AS-2627Q-HB (Queen)
48" high

AS-2627F-HB (Full)
48" high

AS-2627T-HB (Twin)
48" high

Avenue Sleigh Bed

Available with underbed storage options.

Regular Footboard

AV-1101-K (King)
79³/₈"w 93"l
HB 58"h ■ FB 30"h

AV-1101-Q (Queen)
64"w 93"l
HB 58"h ■ FB 30"h

AV-1101-F (Full)
56⁷/₈"w 88"l
HB 58"h ■ FB 30"h

AV-1101-T (Twin)
42"w 88"l
HB 58"h ■ FB 30"h

Low Footboard

AV-1102-K (King)
79³/₈"w 88³/₄"l
HB 58"h ■ FB 14³/₄"h

AV-1102-Q (Queen)
64"w 88³/₄"l
HB 58"h ■ FB 14³/₄"h

AV-1102-F (Full)
56⁷/₈"w 83³/₄"l
HB 58"h ■ FB 14³/₄"h

AV-1102-T (Twin)
42"w 83³/₄"l
HB 58"h ■ FB 14³/₄"h

Headboard Only

AV-1103K-HB (King)
58" high

AV-1103Q-HB (Queen)
58" high

AV-1103F-HB (Full)
58" high

AV-1103T-HB (Twin)
58" high



Shown with Regular Footboard



Shown with Low Footboard

Barrington Bed w/Fabric Panels

Available with underbed storage options.

Regular Footboard

BR-1417-K (King)
78⁵/₈"w 84¹/₂"l
HB 54"h ■ FB 30"h

BR-1417-Q (Queen)
63¹/₈"w 84¹/₂"l
HB 54"h ■ FB 30"h

BR-1417-F (Full)
55⁷/₈"w 79¹/₂"l
HB 54"h ■ FB 30"h

BR-1417-T (Twin)
41"w 79¹/₂"l
HB 54"h ■ FB 30"h

Low Footboard

BR-1425-K (King)
78⁵/₈"w 84¹/₂"l
HB 54"h ■ FB 14³/₄"h

BR-1425-Q (Queen)
63¹/₈"w 84¹/₂"l
HB 54"h ■ FB 14³/₄"h

BR-1425-F (Full)
55⁷/₈"w 79¹/₂"l
HB 54"h ■ FB 14³/₄"h

BR-1425-T (Twin)
41"w 79¹/₂"l
HB 54"h ■ FB 14³/₄"h

Headboard Only

BR-1433K-HB (King)
54" high

BR-1433Q-HB (Queen)
54" high

BR-1433F-HB (Full)
54" high

BR-1433T-HB (Twin)
54" high

Barrington Bed w/Wood Panels

Available with underbed storage options.

Regular Footboard

BR-1414-K (King)
78⁵/₈"w 84¹/₂"l
HB 54"h ■ FB 30"h

BR-1414-Q (Queen)
63¹/₈"w 84¹/₂"l
HB 54"h ■ FB 30"h

BR-1414-F (Full)
55⁷/₈"w 79¹/₂"l
HB 54"h ■ FB 30"h

BR-1414-T (Twin)
41"w 79¹/₂"l
HB 54"h ■ FB 30"h

Low Footboard

BR-1422-K (King)
78⁵/₈"w 84¹/₂"l
HB 54"h ■ FB 14³/₄"h

BR-1422-Q (Queen)
63¹/₈"w 84¹/₂"l
HB 54"h ■ FB 14³/₄"h

BR-1422-F (Full)
55⁷/₈"w 79¹/₂"l
HB 54"h ■ FB 14³/₄"h

BR-1422-T (Twin)
41"w 79¹/₂"l
HB 54"h ■ FB 14³/₄"h

Headboard Only

BR-1430K-HB (King)
54" high

BR-1430Q-HB (Queen)
54" high

BR-1430F-HB (Full)
54" high

BR-1430T-HB (Twin)
54" high



Shown with Regular Footboard



Shown with Low Footboard

Bevel Panel Sleigh Bed

Available
with underbed
storage options.

Regular Footboard

BP-2675-K (King)
81½"w 91"l
HB 54"h ■ FB 27"h

BP-2675-Q (Queen)
63"w 91"l
HB 54"h ■ FB 27"h

BP-2675-F (Full)
59"w 86"l
HB 54"h ■ FB 27"h

BP-2675-T (Twin)
41"w 86"l
HB 54"h ■ FB 27"h

Low Footboard

BP-2676-K (King)
81½"w 87¾"l
HB 54"h ■ FB 14¾"h

BP-2676-Q (Queen)
63"w 87¾"l
HB 54"h ■ FB 14¾"h

BP-2676-F (Full)
59"w 82¾"l
HB 54"h ■ FB 14¾"h

BP-2676-T (Twin)
41"w 82¾"l
HB 54"h ■ FB 14¾"h

Headboard Only

BP-2677K-HB (King)
54" high

BP-2677Q-HB (Queen)
54" high

BP-2677F-HB (Full)
54" high

BP-2677T-HB (Twin)
54" high

Bookcase Bed - CA

Available
with underbed
storage options.

Headboard depth 10"

CA-1110-K (King)
82"w 92¾"l
HB 50"h ■ FB 14¾"h

CA-1110-Q (Queen)
66½"w 92¾"l
HB 50"h ■ FB 14¾"h

CA-1110-F (Full)
59¾"w 87¾"l
HB 50"h ■ FB 14¾"h

CA-1110-T (Twin)
44½"w 87¾"l
HB 50"h ■ FB 14¾"h

Headboard Only

CA-1112K-HB (King)
50" high

CA-1112Q-HB (Queen)
50" high

CA-1112F-HB (Full)
50" high

CA-1112T-HB (Twin)
50" high



532-SR
Storage
Upgrade ↗

Shown with Low Footboard



Shown with Regular Footboard

Bookcase Bed - SO

Available
with underbed
storage options.

Headboard depth 11 $\frac{3}{4}$ "

SO-1074-K (King)

81 $\frac{7}{8}$ "w 93 $\frac{3}{4}$ "l

HB 49 $\frac{3}{4}$ "h ■ FB 14 $\frac{3}{4}$ "h

SO-1074-Q (Queen)

66"w 93 $\frac{3}{4}$ "l

HB 49 $\frac{3}{4}$ "h ■ FB 14 $\frac{3}{4}$ "h

SO-1074-F (Full)

58 $\frac{7}{8}$ "w 88 $\frac{3}{4}$ "l

HB 49 $\frac{3}{4}$ "h ■ FB 14 $\frac{3}{4}$ "h

SO-1074-T (Twin)

43 $\frac{7}{8}$ "w 88 $\frac{3}{4}$ "l

HB 49 $\frac{3}{4}$ "h ■ FB 14 $\frac{3}{4}$ "h

Headboard Only

SO-1076K-HB (King)

49 $\frac{3}{4}$ " high

SO-1076Q-HB (Queen)

49 $\frac{3}{4}$ " high

SO-1076F-HB (Full)

49 $\frac{3}{4}$ " high

SO-1076T-HB (Twin)

49 $\frac{3}{4}$ " high

Brookstone Bed

Available
with underbed
storage options.

Regular Footboard

BP-2865-K (King)

82 $\frac{5}{8}$ "w 89"l

HB 55 $\frac{1}{4}$ "h ■ FB 34" h

BP-2865-Q (Queen)

67" w 89"l

HB 55 $\frac{1}{4}$ "h ■ FB 34" h

BP-2865-F (Full)

59 $\frac{7}{8}$ "w 84"l

HB 55 $\frac{1}{4}$ "h ■ FB 34" h

BP-2865-T (Twin)

45" w 84"l

HB 55 $\frac{1}{4}$ "h ■ FB 34" h

Low Footboard

BK-2866-K (King)

82 $\frac{5}{8}$ "w 87 $\frac{1}{4}$ "l

HB 55 $\frac{1}{4}$ "h ■ FB 14 $\frac{3}{4}$ "h

BK-2866-Q (Queen)

67" w 87 $\frac{1}{4}$ "l

HB 55 $\frac{1}{4}$ "h ■ FB 14 $\frac{3}{4}$ "h

BK-2866-F (Full)

59 $\frac{7}{8}$ "w 82 $\frac{1}{4}$ "l

HB 55 $\frac{1}{4}$ "h ■ FB 14 $\frac{3}{4}$ "h

BK-2866-T (Twin)

45" w 82 $\frac{1}{4}$ "l

HB 55 $\frac{1}{4}$ "h ■ FB 14 $\frac{3}{4}$ "h

Headboard Only

BK-2867K-HB (King)

55 $\frac{1}{4}$ " high

BK-2867Q-HB (Queen)

55 $\frac{1}{4}$ " high

BK-2867F-HB (Full)

55 $\frac{1}{4}$ " high

BK-2867T-HB (Twin)

55 $\frac{1}{4}$ " high



Shown with Regular Footboard



532-SR
Storage
Upgrade

Shown with Regular Footboard

Cabin Creek Bed Regular Footboard

Available
with underbed
storage options.

CA-564-K (King)

82 $\frac{1}{8}$ "w 89 $\frac{1}{2}$ "l
HB 49 $\frac{1}{4}$ "h ■ FB 21 $\frac{1}{4}$ "h

CA-564-Q (Queen)

66 $\frac{5}{8}$ "w 89 $\frac{1}{2}$ "l
HB 49 $\frac{1}{4}$ "h ■ FB 21 $\frac{1}{4}$ "h

CA-564-F (Full)

59 $\frac{3}{8}$ "w 84 $\frac{1}{2}$ "l
HB 49 $\frac{1}{4}$ "h ■ FB 21 $\frac{1}{4}$ "h

CA-564-T (Twin)

44 $\frac{1}{2}$ "w 84 $\frac{1}{2}$ "l
HB 49 $\frac{1}{4}$ "h ■ FB 21 $\frac{1}{4}$ "h

Headboard Only

CA-568K-HB (King)

49 $\frac{1}{4}$ " high

CA-568Q-HB (Queen)

49 $\frac{1}{4}$ " high

CA-568F-HB (Full)

49 $\frac{1}{4}$ " high

CA-568T-HB (Twin)

49 $\frac{1}{4}$ " high

Cabin Creek Bed w/Canopy Regular Footboard

Available
with underbed
storage options.

CA-566-K (King)

82 $\frac{1}{8}$ "w 89 $\frac{1}{2}$ "l
HB 49 $\frac{1}{4}$ "h ■ FB 21 $\frac{1}{4}$ "h

CA-566-Q (Queen)

66 $\frac{5}{8}$ "w 89 $\frac{1}{2}$ "l
HB 49 $\frac{1}{4}$ "h ■ FB 21 $\frac{1}{4}$ "h

CA-566-F (Full)

59 $\frac{3}{8}$ "w 84 $\frac{1}{2}$ "l
HB 49 $\frac{1}{4}$ "h ■ FB 21 $\frac{1}{4}$ "h

CA-566-T (Twin)

44 $\frac{1}{2}$ "w 84 $\frac{1}{2}$ "l
HB 49 $\frac{1}{4}$ "h ■ FB 21 $\frac{1}{4}$ "h



Shown with Regular Footboard & Leather Panels



Shown with Regular Footboard

Canyon Creek Bed

Available with underbed storage options.

Regular Footboard

CC-2565-K (King)
82 $\frac{5}{8}$ "w 88"l
HB 58"h ■ FB 27"h

CC-2565-Q (Queen)
67"w 88"l
HB 58"h ■ FB 27"h

CC-2565-F (Full)
59 $\frac{7}{8}$ "w 83"l
HB 58"h ■ FB 27"h

CC-2565-T (Twin)
45"w 83"l
HB 58"h ■ FB 27"h

Low Footboard

CC-2566-K (King)
82 $\frac{5}{8}$ "w 86 $\frac{1}{4}$ "l
HB 58"h ■ FB 14 $\frac{3}{4}$ "h

CC-2566-Q (Queen)
67"w 86 $\frac{1}{4}$ "l
HB 58"h ■ FB 14 $\frac{3}{4}$ "h

CC-2566-F (Full)
59 $\frac{7}{8}$ "w 81 $\frac{1}{4}$ "l
HB 58"h ■ FB 14 $\frac{3}{4}$ "h

CC-2566-T (Twin)
45"w 81 $\frac{1}{4}$ "l
HB 58"h ■ FB 14 $\frac{3}{4}$ "h

Headboard Only

CC-2567K-HB (King)
58" high

CC-2567Q-HB (Queen)
58" high

CC-2567F-HB (Full)
58" high

CC-2567T-HB (Twin)
58" high

Claremont Panel Bed

Available with underbed storage options.

Regular Footboard

CM-2002-K (King)
81 $\frac{5}{8}$ "w 85 $\frac{3}{4}$ "l
HB 54"h ■ FB 30"h

CM-2002-Q (Queen)
66 $\frac{1}{8}$ "w 85 $\frac{3}{4}$ "l
HB 54"h ■ FB 30"h

CM-2002-F (Full)
58 $\frac{7}{8}$ "w 80 $\frac{3}{4}$ "l
HB 54"h ■ FB 30"h

CM-2002-T (Twin)
44"w 80 $\frac{3}{4}$ "l
HB 54"h ■ FB 30"h

Low Footboard

CM-2003-K (King)
81 $\frac{5}{8}$ "w 85 $\frac{3}{4}$ "l
HB 54"h ■ FB 14 $\frac{3}{4}$ "h

CM-2003-Q (Queen)
66 $\frac{1}{8}$ "w 85 $\frac{3}{4}$ "l
HB 54"h ■ FB 14 $\frac{3}{4}$ "h

CM-2003-F (Full)
58 $\frac{7}{8}$ "w 80 $\frac{3}{4}$ "l
HB 54"h ■ FB 14 $\frac{3}{4}$ "h

CM-2003-T (Twin)
44"w 80 $\frac{3}{4}$ "l
HB 54"h ■ FB 14 $\frac{3}{4}$ "h

Headboard Only

CM-2001K-HB (King)
54" high

CM-2001Q-HB (Queen)
54" high

CM-2001F-HB (Full)
54" high

CM-2001T-HB (Twin)
54" high



234-SR
Storage
Upgrade

Shown with Regular Footboard



Claremont Slat Bed

Available
with underbed
storage options.

Regular Footboard

CM-1983-K (King)
81 $\frac{7}{8}$ "w 85 $\frac{3}{4}$ "l
HB 54"h ■ FB 30"h

CM-1983-Q (Queen)
66 $\frac{1}{8}$ "w 85 $\frac{3}{4}$ "l
HB 54"h ■ FB 30"h

CM-1983-F (Full)
58 $\frac{7}{8}$ "w 80 $\frac{3}{4}$ "l
HB 54"h ■ FB 30"h

CM-1983-T (Twin)
44"w 80 $\frac{3}{4}$ "l
HB 54"h ■ FB 30"h

Low Footboard

CM-1990-K (King)
81 $\frac{7}{8}$ "w 85 $\frac{3}{4}$ "l
HB 54"h ■ FB 14 $\frac{3}{4}$ "h

CM-1990-Q (Queen)
66 $\frac{1}{8}$ "w 85 $\frac{3}{4}$ "l
HB 54"h ■ FB 14 $\frac{3}{4}$ "h

CM-1990-F (Full)
58 $\frac{7}{8}$ "w 80 $\frac{3}{4}$ "l
HB 54"h ■ FB 14 $\frac{3}{4}$ "h

CM-1990-T (Twin)
44"w 80 $\frac{3}{4}$ "l
HB 54"h ■ FB 14 $\frac{3}{4}$ "h

Headboard Only

CM-1982K-HB (King)
54" high

CM-1982Q-HB (Queen)
54" high

CM-1982F-HB (Full)
54" high

CM-1982T-HB (Twin)
54" high

Deluxe Poster Bed

Available
with underbed
storage options.

Regular Footboard

DP-2685-K (King)
81 $\frac{7}{8}$ "w 89"l
HB 69 $\frac{1}{2}$ "h ■ FB 62"h

DP-2685-Q (Queen)
66"w 89"l
HB 69 $\frac{1}{2}$ "h ■ FB 62"h

DP-2685-F (Full)
58 $\frac{7}{8}$ "w 84"l
HB 69 $\frac{1}{2}$ "h ■ FB 62"h

DP-2685-T (Twin)
44"w 84"l
HB 69 $\frac{1}{2}$ "h ■ FB 62"h

Headboard Only

DP-2687K-HB (King)
69 $\frac{1}{2}$ " high

DP-2687Q-HB (Queen)
69 $\frac{1}{2}$ " high

DP-2687F-HB (Full)
69 $\frac{1}{2}$ " high

DP-2687T-HB (Twin)
69 $\frac{1}{2}$ " high



Shown with Regular Footboard



Shown with Regular Footboard

Double Bow Bed

Available with underbed storage options.

Regular Footboard

LE-480-K (King)

79 1/4"w 87"l
HB 47 1/4"h ■ FB 36 1/4"h

LE-480-Q (Queen)

63 1/2"w 87"l
HB 47 1/4"h ■ FB 36 1/4"h

LE-480-F (Full)

57"w 82"l
HB 47 1/4"h ■ FB 36 1/4"h

LE-480-T (Twin)

41 1/4"w 82"l
HB 47 1/4"h ■ FB 36 1/4"h

Low Footboard

LE-479-K (King)

79 1/4"w 85 3/4"l
HB 47 1/4"h ■ FB 14 3/4"h

LE-479-Q (Queen)

63 1/2"w 85 3/4"l
HB 47 1/4"h ■ FB 14 3/4"h

LE-479-F (Full)

57"w 80 3/4"l
HB 47 1/4"h ■ FB 14 3/4"h

LE-479-T (Twin)

41 1/4"w 80 3/4"l
HB 47 1/4"h ■ FB 14 3/4"h

Headboard Only

LE-478-HB-K (King)

47 1/4" high

LE-478-HB-Q (Queen)

47 1/4" high

LE-478-HB-F (Full)

47 1/4" high

LE-478-HB-T (Twin)

47 1/4" high

Dowel Bed

Available with underbed storage options.

Regular Footboard

LE-481-K (King)

85"w 87"l
HB 54 1/2"h ■ FB 38 1/2"h

LE-481-Q (Queen)

69"w 87"l
HB 52 1/2"h ■ FB 36 1/2"h

LE-481-F (Full)

62 1/2"w 82"l
HB 51"h ■ FB 35"h

LE-481-T (Twin)

46 1/2"w 82"l
HB 49"h ■ FB 33"h

Low Footboard

LE-483-K (King)

85"w 85 3/4"l
HB 54 1/2"h ■ FB 14 3/4"h

LE-483-Q (Queen)

69"w 85 3/4"l
HB 52 1/2"h ■ FB 14 3/4"h

LE-483-F (Full)

62 1/2"w 80 3/4"l
HB 51"h ■ FB 14 3/4"h

LE-483-T (Twin)

46 1/2"w 80 3/4"l
HB 49"h ■ FB 14 3/4"h

Headboard Only

LE-485K-HB (King)

54 1/2" high

LE-485Q-HB (Queen)

52 1/2" high

LE-485F-HB (Full)

51" high

LE-485T-HB (Twin)

49" high



532-SR
Storage
Upgrade

Shown with Regular Footboard



234-SR
Storage
Upgrade

Shown with Low Footboard

Dreamland Bed

Regular Footboard

Available
with underbed
storage options.

CA-595-K (King)
79 3/8"w 84 1/2"l
HB 48"h ■ FB 30"h

CA-595-Q (Queen)
64 1/8"w 84 1/2"l
HB 48"h ■ FB 30"h

CA-595-F (Full)
56 7/8"w 79 1/2"l
HB 48"h ■ FB 30"h

CA-595-T (Twin)
42"w 79 1/2"l
HB 48"h ■ FB 30"h

Low Footboard

CA-597-K (King)
79 3/8"w 84 1/2"l
HB 48"h ■ FB 14 3/4"h

CA-597-Q (Queen)
64 1/8"w 84 1/2"l
HB 48"h ■ FB 14 3/4"h

CA-597-F (Full)
56 7/8"w 79 1/2"l
HB 48"h ■ FB 14 3/4"h

CA-597-T (Twin)
42"w 79 1/2"l
HB 48"h ■ FB 14 3/4"h

Headboard Only

CA-599K-HB (King)
48" high

CA-599Q-HB (Queen)
48" high

CA-599F-HB (Full)
48" high

CA-599T-HB (Twin)
48" high

Elk Ridge Sleigh Bed

Regular Footboard

Available
with underbed
storage options.

ER-1930-K (King)
79 3/8"w 93"l
HB 59"h ■ FB 30"h

ER-1930-Q (Queen)
64"w 93"l
HB 59"h ■ FB 30"h

ER-1930-F (Full)
56 7/8"w 88"l
HB 59"h ■ FB 30"h

ER-1930-T (Twin)
42"w 88"l
HB 59"h ■ FB 30"h

Low Footboard

ER-1932-K (King)
79 3/8"w 88 3/4"l
HB 59"h ■ FB 14 3/4"h

ER-1932-Q (Queen)
64"w 88 3/4"l
HB 59"h ■ FB 14 3/4"h

ER-1932-F (Full)
56 7/8"w 83 3/4"l
HB 59"h ■ FB 14 3/4"h

ER-1932-T (Twin)
42"w 83 3/4"l
HB 59"h ■ FB 14 3/4"h

Headboard Only

ER-1940K-HB (King)
59" high

ER-1940Q-HB (Queen)
59" high

ER-1940F-HB (Full)
59" high

ER-1940T-HB (Twin)
59" high



**Post Height
84"**
Posts are
removable

Shown with Regular Footboard



**234-SR
Storage
Upgrade**

Shown with Regular Footboard

Glendale Poster Bed

Available
with underbed
storage options.

Regular Footboard

GD-1890-K (King)
80 1/8"w 87 1/2"l
HB 48"h ■ FB 14"h

GD-1890-Q (Queen)
64 3/8"w 87 1/2"l
HB 48"h ■ FB 14"h

GD-1890-F (Full)
57 3/8"w 82 1/2"l
HB 48"h ■ FB 14"h

GD-1890-T (Twin)
42 1/2"w 82 1/2"l
HB 48"h ■ FB 14"h

Headboard Only

GD-1900K-HB (King)
48" high

GD-1900Q-HB (Queen)
48" high

GD-1900F-HB (Full)
48" high

GD-1900T-HB (Twin)
48" high

Hamilton Bed Regular Footboard

Available
with underbed
storage options.

HM-1880-K (King)
82 3/4"w 86 1/8"l
HB 60"h ■ FB 22"h

HM-1880-Q (Queen)
67 1/4"w 86 1/8"l
HB 60"h ■ FB 22"h

HM-1880-F (Full)
60 1/8"w 81 1/8"l
HB 60"h ■ FB 22"h

HM-1880-T (Twin)
45 1/4"w 81 1/8"l
HB 60"h ■ FB 22"h

Low Footboard

HM-1882-K (King)
82 3/4"w 84 1/2"l
HB 60"h ■ FB 14 3/4"h

HM-1882-Q (Queen)
67 1/4"w 84 1/2"l
HB 60"h ■ FB 14 3/4"h

HM-1882-F (Full)
60 1/8"w 79 1/2"l
HB 60"h ■ FB 14 3/4"h

HM-1882-T (Twin)
45 1/4"w 79 1/2"l
HB 60"h ■ FB 14 3/4"h

Headboard Only

HM-1885K-HB (King)
60" high

HM-1885Q-HB (Queen)
60" high

HM-1885F-HB (Full)
60" high

HM-1885T-HB (Twin)
60" high



Shown with Regular Footboard



Shown with Low Footboard

Huntington Bed

Regular Footboard

Available
with underbed
storage options.

HT-2125K (King)
83⁵/₈"w 91"l
HB 63¹/₄"h ■ FB 29"h

HT-2125Q (Queen)
68"w 91"l
HB 63¹/₄"h ■ FB 29"h

HT-2125F (Full)
60⁷/₈"w 86"l
HB 63¹/₄"h ■ FB 29"h

HT-2125T (Twin)
46"w 86"l
HB 63¹/₄"h ■ FB 29"h

Low Footboard

HT-2126K (King)
83⁵/₈"w 87³/₄"l
HB 63¹/₄"h ■ FB 29"h

HT-2126Q (Queen)
68"w 87³/₄"l
HB 63¹/₄"h ■ FB 29"h

HT-2126F (Full)
60⁷/₈"w 82³/₄"l
HB 63¹/₄"h ■ FB 29"h

HT-2126T (Twin)
46"w 82³/₄"l
HB 63¹/₄"h ■ FB 29"h

Headboard Only

HT-2127K-HB (King)
63¹/₄" high

HT-2127Q-HB (Queen)
63¹/₄" high

HT-2127F-HB (Full)
63¹/₄" high

HT-2127T-HB (Twin)
63¹/₄" high

Lewiston Bed

Regular Footboard

Available
with underbed
storage options.

LN-2365-K (King)
80¹/₈"w 85¹/₂"l
HB 54"h ■ FB 30¹/₄"h

LN-2365-Q (Queen)
64¹/₂"w 85¹/₂"l
HB 54"h ■ FB 30¹/₄"h

LN-2365-F (Full)
57³/₈"w 80¹/₂"l
HB 54"h ■ FB 30¹/₄"h

LN-2365-T (Twin)
42¹/₂"w 80¹/₂"l
HB 54"h ■ FB 30¹/₄"h

Low Footboard

LN-2366-K (King)
80¹/₈"w 84¹/₂"l
HB 54"h ■ FB 16"h

LN-2366-Q (Queen)
64¹/₂"w 84¹/₂"l
HB 54"h ■ FB 16"h

LN-2366-F (Full)
57³/₈"w 79¹/₂"l
HB 54"h ■ FB 16"h

LN-2366-T (Twin)
42¹/₂"w 79¹/₂"l
HB 54"h ■ FB 16"h

Headboard Only

LN-2367K-HB (King)
54" high

LN-2367Q-HB (Queen)
54" high

LN-2367F-HB (Full)
54" high

LN-2367T-HB (Twin)
54" high



Shown with Regular Footboard



Also available
w/Fabric or Leather
Panel in Headboard

532-SR
Storage
Upgrade

Shown with Regular Footboard

Lindenhurst Sleigh Bed

Regular Footboard

Available with underbed storage options.

LH-1520-K (King)
79 1/8" w 89 1/4" l
HB 48" h ■ FB 30" h

LH-1520-Q (Queen)
63 5/8" w 89 1/4" l
HB 48" h ■ FB 30" h

LH-1520-F (Full)
56 3/8" w 85 1/4" l
HB 48" h ■ FB 30" h

LH-1520-T (Twin)
41 5/8" w 85 1/4" l
HB 48" h ■ FB 30" h

Low Footboard

LH-1522-K (King)
79 1/8" w 89 3/8" l
HB 48" h ■ FB 14 3/4" h

LH-1522-Q (Queen)
63 5/8" w 89 3/8" l
HB 48" h ■ FB 14 3/4" h

LH-1522-F (Full)
56 3/8" w 84 3/8" l
HB 48" h ■ FB 14 3/4" h

LH-1522-T (Twin)
41 5/8" w 84 3/8" l
HB 48" h ■ FB 14 3/4" h

Headboard Only

LH-1525-HB-K (King)
48" high

LH-1525-HB-Q (Queen)
48" high

LH-1525-HB-F (Full)
48" high

LH-1525-HB-T (Twin)
48" high

Luellen Bed

Regular Footboard

Available with underbed storage options.

LE-1451-K (King)
83 5/8" w 91" l
HB 65 7/8" h ■ FB 35 7/8" h

LE-1451-Q (Queen)
68 1/8" w 91" l
HB 65 7/8" h ■ FB 35 7/8" h

LE-1451-F (Full)
60 7/8" w 86" l
HB 65 7/8" h ■ FB 35 7/8" h

LE-1451-T (Twin)
46" w 86" l
HB 65 7/8" h ■ FB 35 7/8" h

Low Footboard

LE-1457-K (King)
83 5/8" w 87 3/4" l
HB 65 7/8" h ■ FB 14 3/4" h

LE-1457-Q (Queen)
68 1/8" w 87 3/4" l
HB 65 7/8" h ■ FB 14 3/4" h

LE-1457-F (Full)
60 7/8" w 82 3/4" l
HB 65 7/8" h ■ FB 14 3/4" h

LE-1457-T (Twin)
46" w 82 3/4" l
HB 65 7/8" h ■ FB 14 3/4" h

Headboard Only

LE-1463K-HB (King)
65 7/8" high

LE-1463Q-HB (Queen)
65 7/8" high

LE-1463F-HB (Full)
65 7/8" high

LE-1463T-HB (Twin)
65 7/8" high



Shown with Regular Footboard



Shown with Regular Footboard

Manhattan Curved Bed

Available with underbed storage options.

Regular Footboard

MH-2171-K (King)

82½"w 87"l

HB 59¼"h ■ FB 30¼"h

MH-2171-Q (Queen)

66½"w 87"l

HB 57¼"h ■ FB 30¼"h

MH-2171-F (Full)

59¾"w 82"l

HB 55¾"h ■ FB 30¼"h

MH-2171-T (Twin)

44½"w 82"l

HB 53¾"h ■ FB 30¼"h

Low Footboard

MH-2178-K (King)

82½"w 85¾"l

HB 59¼"h ■ FB 14¾"h

MH-2178-Q (Queen)

66½"w 85¾"l

HB 57¼"h ■ FB 14¾"h

MH-2178-F (Full)

59¾"w 80¾"l

HB 55¾"h ■ FB 14¾"h

MH-2178-T (Twin)

44½"w 80¾"l

HB 53¾"h ■ FB 14¾"h

Headboard Only

MH-2170K-HB (King)

59¼" high

MH-2170Q-HB (Queen)

57¼" high

MH-2170F-HB (Full)

55¾" high

MH-2170T-HB (Twin)

53¾" high

Manhattan Panel Bed

Available with underbed storage options.

Regular Footboard

MH-2174-K (King)

82½"w 86½"l

HB 53"h ■ FB 30"h

MH-2174-Q (Queen)

66½"w 86½"l

HB 53"h ■ FB 30" h

MH-2174-F (Full)

59¾"w 81½"l

HB 53"h ■ FB 30" h

MH-2174-T (Twin)

44½"w 81½"l

HB 53" h ■ FB 30" h

Low Footboard

MH-2175-K (King)

82½"w 85½"l

HB 53" h ■ FB 14¾" h

MH-2175-Q (Queen)

66½"w 85½"l

HB 53" h ■ FB 14¾" h

MH-2175-F (Full)

59¾"w 80½"l

HB 53" h ■ FB 14¾" h

MH-2175-T (Twin)

44½"w 80½"l

HB 53" h ■ FB 14¾" h

Headboard Only

MH-2173K-HB (King)

53" high

MH-2173Q-HB (Queen)

53" high

MH-2173F-HB (Full)

53" high

MH-2173T-HB (Twin)

53" high



Shown with Regular Footboard



Shown with Regular Footboard and 234 Storage Upgrade

Olde Cottage Bed

Available with underbed storage options.

Regular Footboard

OD-2765-K (King)
81⁵/₈"w 87¹/₂"l
HB 56"h ■ FB 17"h

OD-2765-Q (Queen)
66"w 87¹/₂"l
HB 56"h ■ FB 17"h

OD-2765-F (Full)
58⁷/₈"w 82¹/₂"l
HB 56"h ■ FB 17"h

OD-2765-T (Twin)
44"w 82¹/₂"l
HB 56"h ■ FB 17"h

Low Footboard

OD-2766-K (King)
81⁵/₈"w 86"l
HB 56"h ■ FB 14³/₄"h

OD-2766-Q (Queen)
66"w 86"l
HB 56"h ■ FB 14³/₄"h

OD-2766-F (Full)
58⁷/₈"w 81"l
HB 56"h ■ FB 14³/₄"h

OD-2766-T (Twin)
44"w 81"l
HB 56"h ■ FB 14³/₄"h

Headboard Only

OD-2767K-HB (King)
56" high

OD-2767Q-HB (Queen)
56" high

OD-2767F-HB (Full)
56" high

OD-2767T-HB (Twin)
56" high

Open Sleigh Bed

Available with underbed storage options.

Regular Footboard

OS-2695-K (King)
79"w 94"l
HB 53"h ■ FB 33"h

OS-2695-Q (Queen)
63⁵/₈"w 94"l
HB 53"h ■ FB 33"h

OS-2695-F (Full)
56¹/₂"w 89"l
HB 53"h ■ FB 33"h

OS-2695-T (Twin)
41⁵/₈"w 89"l
HB 53"h ■ FB 33"h

Low Footboard

OS-2696-K (King)
79"w 89³/₄"l
HB 53"h ■ FB 14³/₄"h

OS-2696-Q (Queen)
63⁵/₈"w 89³/₄"l
HB 53"h ■ FB 14³/₄"h

OS-2696-F (Full)
56¹/₂"w 84³/₄"l
HB 53"h ■ FB 14³/₄"h

OS-2696-T (Twin)
41⁵/₈"w 84³/₄"l
HB 53"h ■ FB 14³/₄"h

Headboard Only

OS-2697K-HB (King)
53" high

OS-2697Q-HB (Queen)
53" high

OS-2697F-HB (Full)
53" high

OS-2697T-HB (Twin)
53" high



Shown with Regular Footboard



Shown with Regular Footboard

Panel Bed

Regular Footboard

Available
with underbed
storage options.

SO-1050-K (King)

82¼"w 87½"l

HB 52¾"h ■ FB 30¾"h

SO-1050-Q (Queen)

66⅝"w 87½"l

HB 52¾"h ■ FB 30¾"h

SO-1050-F (Full)

59½"w 82⅝"l

HB 52¾"h ■ FB 30¾"h

SO-1050-T (Twin)

44¾"w 82⅝"l

HB 52¾"h ■ FB 30¾"h

Low Footboard

SO-1052-K (King)

82¼"w 85¾"l

HB 52¾"h ■ FB 14¾"h

SO-1052-Q (Queen)

66⅝"w 85¾"l

HB 52¾"h ■ FB 14¾"h

SO-1052-F (Full)

59½"w 80¾"l

HB 52¾"h ■ FB 14¾"h

SO-1052-T (Twin)

44¾"w 80¾"l

HB 52¾"h ■ FB 14¾"h

Headboard Only

SO-1054K-HB (King)

52¾" high

SO-1054Q-HB (Queen)

52¾" high

SO-1054F-HB (Full)

52¾" high

SO-1054T-HB (Twin)

52¾" high

Prairie Bed

Regular Footboard

Available
with underbed
storage options.

PI-1122-K (King)

81⅝"w 84½"l

HB 53"h ■ FB 30"h

PI-1122-Q (Queen)

66"w 84½"l

HB 53"h ■ FB 30"h

PI-1122-F (Full)

58⅞"w 79½"l

HB 53"h ■ FB 30"h

PI-1122-T (Twin)

44"w 79½"l

HB 53"h ■ FB 30"h

Low Footboard

PI-1124-K (King)

81⅝"w 84½"l

HB 53"h ■ FB 14¾"h

PI-1124-Q (Queen)

66"w 84½"l

HB 53"h ■ FB 14¾"h

PI-1124-F (Full)

58⅞"w 79½"l

HB 53"h ■ FB 14¾"h

PI-1124-T (Twin)

44"w 79½"l

HB 53"h ■ FB 14¾"h

Headboard Only

PI-1126K-HB (King)

53" high

PI-1126Q-HB (Queen)

53" high

PI-1126F-HB (Full)

53" high

PI-1126T-HB (Twin)

53" high



Shown with Regular Footboard



532-SR Storage Upgrade

Shown with Regular Footboard

Rainbow Panel Bed Regular Footboard

Available with underbed storage options.

CA-441-K (King)
85¾" w 87" l
HB 59¼" h ■ FB 30¼" h

CA-441-Q (Queen)
70¼" w 87" l
HB 57¼" h ■ FB 30¼" h

CA-441-F (Full)
63" w 82" l
HB 55¾" h ■ FB 30¼" h

CA-441-T (Twin)
48½" w 82" l
HB 53¾" h ■ FB 30¼" h

Low Footboard

CA-443-K (King)
85¾" w 85¾" l
HB 59¼" h ■ FB 14¾" h

CA-443-Q (Queen)
70¼" w 85¾" l
HB 57¼" h ■ FB 14¾" h

CA-443-F (Full)
63" w 80¾" l
HB 55¾" h ■ FB 14¾" h

CA-443-T (Twin)
48½" w 80¾" l
HB 53¾" h ■ FB 14¾" h

Headboard Only

CA-446K-HB (King)
59¼" high

CA-446Q-HB (Queen)
57¼" high

CA-446F-HB (Full)
55¾" high

CA-446T-HB (Twin)
53¾" high

Rainbow Spindle Bed Regular Footboard

Available with underbed storage options.

CA-527-K (King)
85¾" w 87" l
HB 59¼" h ■ FB 30¼" h

CA-527-Q (Queen)
70¼" w 87" l
HB 57¼" h ■ FB 30¼" h

CA-527-F (Full)
63" w 82" l
HB 55¾" h ■ FB 30¼" h

CA-527-T (Twin)
48½" w 82" l
HB 53¾" h ■ FB 30¼" h

Low Footboard

CA-529-K (King)
85¾" w 85¾" l
HB 59¼" h ■ FB 14¾" h

CA-529-Q (Queen)
70¼" w 85¾" l
HB 57¼" h ■ FB 14¾" h

CA-529-F (Full)
63" w 80¾" l
HB 55¾" h ■ FB 14¾" h

CA-529-T (Twin)
48½" w 80¾" l
HB 53¾" h ■ FB 14¾" h

Headboard Only

CA-531K-HB (King)
59¼" high

CA-531Q-HB (Queen)
57¼" high

CA-531F-HB (Full)
55¾" high

CA-531T-HB (Twin)
53¾" high



Shown with Regular Footboard
and 532 Storage Upgrade



Shown with Regular Footboard

Regency Bed

Regular Footboard

Available
with underbed
storage options.

RG-2665-K (King)
79½"w 96½"l
HB 58"h ■ FB 38½"h

RG-2665-Q (Queen)
64½"w 96½"l
HB 58"h ■ FB 38½"h

RG-2665-F (Full)
57"w 91½"l
HB 58"h ■ FB 38½"h

RG-2665-T (Twin)
42½"w 91½"l
HB 58"h ■ FB 38½"h

Low Footboard

RG-2666-K (King)
79½"w 90¾"l
HB 58"h ■ FB 14¾"h

RG-2666-Q (Queen)
64½"w 90¾"l
HB 58"h ■ FB 14¾"h

RG-2666-F (Full)
57"w 85¾"l
HB 58"h ■ FB 14¾"h

RG-2666-T (Twin)
42½"w 85¾"l
HB 58"h ■ FB 14¾"h

Headboard Only

RG-2667K-HB (King)
58" high

RG-2667Q-HB (Queen)
58" high

LN-2667F-HB (Full)
58" high

LN-2667T-HB (Twin)
58" high

Rosedale Bed

Regular Footboard

Available
with underbed
storage options.

RD-3165-K (King)
82½"w 87"l
HB 58"h ■ FB 18"h

RD-3165-Q (Queen)
66½"w 87"l
HB 58"h ■ FB 18"h

RD-3165-F (Full)
59¾"w 82"l
HB 58"h ■ FB 18"h

RD-3165-T (Twin)
44½"w 82"l
HB 58"h ■ FB 18"h

Low Footboard

RD-3166-K (King)
82½"w 85¼"l
HB 58"h ■ FB 14¾"h

RD-3166-Q (Queen)
66½"w 85¼"l
HB 58"h ■ FB 14¾"h

RD-3166-F (Full)
59¾"w 80¼"l
HB 58"h ■ FB 14¾"h

RD-3166-T (Twin)
44½"w 80¼"l
HB 58"h ■ FB 14¾"h

Headboard Only

RD-3167K-HB (King)
58" high

RD-3167Q-HB (Queen)
58" high

RD-3167F-HB (Full)
58" high

RD-3167T-HB (Twin)
58" high



**Post Height
80"**
Posts are
removable

Shown with Regular Footboard



Shown with Regular Footboard

Rosewood Poster Bed

Available
with underbed
storage options.

Regular Footboard

RW-1910-K (King)
80 1/8"w 87 1/2"l
HB 52"h ■ FB 23"h

RW-1910-Q (Queen)
64 3/8"w 87 1/2"l
HB 52"h ■ FB 23"h

RW-1910-F (Full)
57 3/8"w 82 1/2"l
HB 52"h ■ FB 23"h

RW-1910-T (Twin)
42 1/2"w 82 1/2"l
HB 52"h ■ FB 23"h

Headboard Only

RW-1920K-HB (King)
52" high

RW-1920Q-HB (Queen)
52" high

RW-1920F-HB (Full)
52" high

RW-1920T-HB (Twin)
52" high

Shoreview Bed

Available
with underbed
storage options.

Regular Footboard

SH-2088-K (King)
81 1/2"w 85 1/2"l
HB 48"h ■ FB 30"h

SH-2088-Q (Queen)
66"w 85 1/2"l
HB 48"h ■ FB 30"h

SH-2088-F (Full)
58 7/8"w 80 1/2"l
HB 48"h ■ FB 30"h

SH-2088-T (Twin)
44"w 80 1/2"l
HB 48"h ■ FB 30"h

Low Footboard

SH-2090-K (King)
81 1/2"w 84 1/2"l
HB 48"h ■ FB 14 3/4"h

SH-2090-Q (Queen)
66"w 84 1/2"l
HB 48"h ■ FB 14 3/4"h

SH-2090-F (Full)
58 7/8"w 79 1/2"l
HB 48"h ■ FB 14 3/4"h

SH-2090-T (Twin)
44"w 79 1/2"l
HB 48"h ■ FB 14 3/4"h

Headboard Only

SH-2098K-HB (King)
48" high

SH-2098Q-HB (Queen)
48" high

SH-2098F-HB (Full)
48" high

SH-2098T-HB (Twin)
48" high



Shown with Regular Footboard



Shown with Regular Footboard

Single Panel Sleigh Bed

Available with underbed storage options.

Regular Footboard

SP-2705-K (King)
81½" w 95¼" l
HB 52" h ■ FB 25" h

SP-2705-Q (Queen)
66½" w 95¼" l
HB 52" h ■ FB 25" h

SP-2705-F (Full)
59" w 90¼" l
HB 52" h ■ FB 25" h

SP-2705-T (Twin)
44½" w 90¼" l
HB 52" h ■ FB 25" h

Low Footboard

SP-2706-K (King)
81½" w 90¼" l
HB 52" h ■ FB 14¾" h

SP-2706-Q (Queen)
66½" w 90¼" l
HB 52" h ■ FB 14¾" h

SP-2706-F (Full)
59" w 85¼" l
HB 52" h ■ FB 14¾" h

SP-2706-T (Twin)
44½" w 85¼" l
HB 52" h ■ FB 14¾" h

Headboard Only

SP-2707K-HB (King)
52" high

SP-2707Q-HB (Queen)
52" high

SP-2707F-HB (Full)
52" high

SP-2707T-HB (Twin)
52" high

Sleepwell Bed

Available with underbed storage options.

Regular Footboard

SW-491-K (King)
79⅝" w 84½" l
HB 48" h ■ FB 30" h

SW-491-Q (Queen)
64⅜" w 84½" l
HB 48" h ■ FB 30" h

SW-491-F (Full)
56⅞" w 79½" l
HB 48" h ■ FB 30" h

SW-491-T (Twin)
42" w 79½" l
HB 48" h ■ FB 30" h

Low Footboard

SW-493-K (King)
79⅝" w 84½" l
HB 48" h ■ FB 14¾" h

SW-493-Q (Queen)
64⅜" w 84½" l
HB 48" h ■ FB 14¾" h

SW-493-F (Full)
56⅞" w 79½" l
HB 48" h ■ FB 14¾" h

SW-493-T (Twin)
42" w 79½" l
HB 48" h ■ FB 14¾" h

Headboard Only

SW-495K-HB (King)
48" high

SW-495Q-HB (Queen)
48" high

SW-495F-HB (Full)
48" high

SW-495T-HB (Twin)
48" high



Shown with Low Footboard



Shown with Low Footboard

Slumberland Bed

Regular Footboard

Available with underbed storage options.

SL-1061-K (King)
79⁵/₈"w 84¹/₂"l
HB 50"h ■ FB 30"h

SL-1061-Q (Queen)
64¹/₈"w 84¹/₂"l
HB 50"h ■ FB 30"h

SL-1061-F (Full)
56⁷/₈"w 79¹/₂"l
HB 50"h ■ FB 30"h

SL-1061-T (Twin)
42"w 79¹/₂"l
HB 50"h ■ FB 30"h

Low Footboard

SL-1063-K (King)
79⁵/₈"w 84¹/₂"l
HB 50"h ■ FB 14³/₄"h

SL-1063-Q (Queen)
64¹/₈"w 84¹/₂"l
HB 50"h ■ FB 14³/₄"h

SL-1063-F (Full)
56⁷/₈"w 79¹/₂"l
HB 50"h ■ FB 14³/₄"h

SL-1063-T (Twin)
42"w 79¹/₂"l
HB 50"h ■ FB 14³/₄"h

Headboard Only

SL-1065K-HB (King)
50" high

SL-1065Q-HB (Queen)
50" high

SL-1065F-HB (Full)
50" high

SL-1065T-HB (Twin)
50" high

Sunrise Queen Bed

Regular Footboard

Available with underbed storage options.

SN-2715-K (King)
79⁵/₈"w 84¹/₂"l
HB 47¹/₄"h ■ FB 30"h

SN-2715-Q (Queen)
64"w 84¹/₂"l
HB 47¹/₄"h ■ FB 30"h

SN-2715-F (Full)
56⁷/₈"w 79¹/₂"l
HB 47¹/₄"h ■ FB 30"h

SN-2715-T (Twin)
42"w 79¹/₂"l
HB 47¹/₄"h ■ FB 30"h

Low Footboard

SN-2716-K (King)
79⁵/₈"w 84¹/₂"l
HB 47¹/₄"h ■ FB 14³/₄"h

SN-2716-Q (Queen)
64"w 84¹/₂"l
HB 47¹/₄"h ■ FB 14³/₄"h

SN-2716-F (Full)
56⁷/₈"w 79¹/₂"l
HB 47¹/₄"h ■ FB 14³/₄"h

SN-2716-T (Twin)
42"w 79¹/₂"l
HB 47¹/₄"h ■ FB 14³/₄"h

Headboard Only

SN-2717K-HB (King)
47¹/₄" high

SN-2717Q-HB (Queen)
47¹/₄" high

SN-2717F-HB (Full)
47¹/₄" high

SN-2717T-HB (Twin)
47¹/₄" high



Shown with Regular Footboard and 685 Storage Upgrade



Shown with Low Footboard

Timber Mill Bed

Available with underbed storage options.

Regular Footboard

TM-3365-K (King)
79 $\frac{3}{8}$ "w 85 $\frac{1}{2}$ "l
HB 55"h ■ FB 33 $\frac{1}{4}$ "h

TM-3365-Q (Queen)
64"w 85 $\frac{1}{2}$ "l
HB 55"h ■ FB 33 $\frac{1}{4}$ "h

TM-3365-F (Full)
56 $\frac{7}{8}$ "w 80 $\frac{1}{2}$ "l
HB 55"h ■ FB 33 $\frac{1}{4}$ "h

TM-3365-T (Twin)
42"w 80 $\frac{1}{2}$ "l
HB 47"h ■ FB 31"h

Low Footboard

TM-3366-K (King)
79 $\frac{3}{4}$ "w 85"l
HB 55"h ■ FB 14 $\frac{3}{4}$ "h

TM-3366-Q (Queen)
64"w 85"l
HB 55"h ■ FB 14 $\frac{3}{4}$ "h

TM-3366-F (Full)
56 $\frac{7}{8}$ "w 80"l
HB 55"h ■ FB 14 $\frac{3}{4}$ "h

TM-3366-T (Twin)
42"w 80"l
HB 55"h ■ FB 14 $\frac{3}{4}$ "h

Headboard Only

TM-3367K-HB (King)
55" high

TM-3367Q-HB (Queen)
55" high

TM-3367F-HB (Full)
55" high

TM-3367T-HB (Twin)
55" high

Wilkenburg Bed

Available with underbed storage options.

Regular Footboard

WB-1736-K (King)
81 $\frac{5}{8}$ "w 86 $\frac{1}{2}$ "l
HB 53"h ■ FB 30"h

WB-1736-Q (Queen)
66"w 86 $\frac{1}{2}$ "l
HB 53"h ■ FB 30"h

WB-1736-F (Full)
58 $\frac{7}{8}$ "w 81 $\frac{1}{2}$ "l
HB 53"h ■ FB 30"h

WB-1736-T (Twin)
44"w 81 $\frac{1}{2}$ "l
HB 53"h ■ FB 30"h

Low Footboard

WB-1738-K (King)
81 $\frac{3}{8}$ "w 85 $\frac{1}{2}$ "l
HB 53"h ■ FB 14 $\frac{3}{4}$ "h

WB-1738-Q (Queen)
66"w 85 $\frac{1}{2}$ "l
HB 53"h ■ FB 14 $\frac{3}{4}$ "h

WB-1738-F (Full)
58 $\frac{7}{8}$ "w 80 $\frac{1}{2}$ "l
HB 53"h ■ FB 14 $\frac{3}{4}$ "h

WB-1738-T (Twin)
44"w 80 $\frac{1}{2}$ "l
HB 53"h ■ FB 14 $\frac{3}{4}$ "h

Headboard Only

WB-1741K-HB (King)
53" high

WB-1741Q-HB (Queen)
53" high

WB-1741F-HB (Full)
53" high

WB-1741T-HB (Twin)
53" high